

Programmable Controller

Transition from MELSEC-AnS/QnAS (Small Type) Series to Q Series Handbook

(Intelligent Function Modules)



Jul. 2018 Edition

● SAFETY PRECAUTIONS ●

(Read these precautions before using this product.)

Before using this product, please read this manual and the relevant manuals carefully and pay full attention to safety to handle the product correctly.

In this manual, the safety precautions are classified into two levels: "⚠ WARNING" and "⚠ CAUTION".



Indicates that incorrect handling may cause hazardous conditions, resulting in death or severe injury.



Indicates that incorrect handling may cause hazardous conditions, resulting in minor or moderate injury or property damage.

Under some circumstances, failure to observe the precautions given under "⚠ CAUTION" may lead to serious consequences.

Observe the precautions of both levels because they are important for personal and system safety.

Make sure that the end users read this manual and then keep the manual in a safe place for future reference.

[Design Precautions]

⚠ WARNING

- Configure safety circuits external to the programmable controller to ensure that the entire system operates safely even when a fault occurs in the external power supply or the programmable controller. Failure to do so may result in an accident due to an incorrect output or malfunction.
 - (1) Configure external safety circuits, such as an emergency stop circuit, protection circuit, and protective interlock circuit for forward/reverse operation or upper/lower limit positioning.
 - (2) When the programmable controller detects the following problems, it will stop calculation and turn off all output in the case of (a).
In the case of (b), it will hold or turn off all output according to the parameter setting.
Note that the AnS series module will turn off the output in either of cases (a) and (b).

	Q series module	AnS series module
(a) The power supply module has over current protection equipment and over voltage protection equipment.	Output OFF	Output OFF
(b) The CPU module self-diagnosis functions, such as the watchdog timer error, detect problems.	Hold or turn off all output according to the parameter setting.	Output OFF

Also, all outputs may be turned on if an error occurs in a part, such as an I/O control part, where the CPU module cannot detect any error. To ensure safety operation in such a case, provide a safety mechanism or a fail-safe circuit external to the programmable controller.

For a fail-safe circuit example, refer to LOADING AND INSTALLATION in the QCPU User's Manual (Hardware Design, Maintenance and Inspection).

- (3) Outputs may remain on or off due to a failure of an output module relay or transistor. Configure an external circuit for monitoring output signals that could cause a serious accident.

[Design Precautions]

WARNING

- In an output module, when a load current exceeding the rated current or an overcurrent caused by a load short-circuit flows for a long time, it may cause smoke and fire. To prevent this, configure an external safety circuit, such as a fuse.
- Configure a circuit so that the programmable controller is turned on first and then the external power supply.
If the external power supply is turned on first, an accident may occur due to an incorrect output or malfunction.
- For the operating status of each station after a communication failure, refer to relevant manuals for each network.
Failure to do so may result in an accident due to an incorrect output or malfunction.
- When changing data of the running programmable controller from a peripheral connected to the CPU module or from a personal computer connected to an intelligent function module or special function module, configure an interlock circuit in the sequence program to ensure that the entire system will always operate safely.
For program modification and operating status change, read relevant manuals carefully and ensure the safety before operation.
Especially, when a remote programmable controller is controlled by an external device, immediate action cannot be taken if a problem occurs in the programmable controller due to a communication failure.
To prevent this, configure an interlock circuit in the sequence program, and determine corrective actions to be taken between the external device and CPU module in case of a communication failure.

CAUTION

- Do not install the control lines or communication cables together with the main circuit lines or power cables.
Keep a distance of 100mm or more between them.
Failure to do so may result in malfunction due to noise.
- When a device such as a lamp, heater, or solenoid valve is controlled through an output module, a large current (approximately ten times greater than normal) may flow when the output is turned from off to on.
Take measures such as replacing the module with one having a sufficient current rating.
- After the CPU module is powered on or is reset, the time taken to enter the RUN status varies depending on the system configuration, parameter settings, and/or program size. Design circuits so that the entire system will always operate safely, regardless of the time.

[Installation Precautions]

CAUTION

- Use the programmable controller in an environment that meets the general specifications in the QCPU User's Manual (Hardware Design, Maintenance and Inspection).
Failure to do so may result in electric shock, fire, malfunction, or damage to or deterioration of the product.
- To mount the module, while pressing the module mounting lever located in the lower part of the module, fully insert the module fixing projection(s) into the hole(s) in the base unit and press the module until it snaps into place.
Incorrect mounting may cause malfunction, failure or drop of the module.
When using the programmable controller in an environment of frequent vibrations, fix the module with a screw.
Tighten the screws within the specified torque range.
Undertightening can cause drop of the screw, short circuit, or malfunction.
Overtightening can damage the screw and/or module, resulting in drop, short circuit, or malfunction.
- When using an extension cable, connect it to the extension cable connector of the base unit securely.
Check the connection for looseness.
Poor contact may cause incorrect input or output.
- When using a memory card, fully insert it into the memory card slot.
Check that it is inserted completely.
Poor contact may cause malfunction.
- Shut off the external power supply (all phases) used in the system before mounting or removing a module. Failure to do so may result in damage to the product. A module can be replaced online (while power is on) on any MELSECNET/H remote I/O station or in the system where a CPU module supporting the online module change function is used.
Note that there are restrictions on the modules that can be replaced online, and each module has its predetermined replacement procedure.
For details, refer to the relevant sections in the QCPU User's Manual (Hardware Design, Maintenance and Inspection) and in the manual for the corresponding module.
- Do not directly touch any conductive part of the module.
Doing so can cause malfunction or failure of the module.

[Wiring Precautions]

WARNING

- Shut off the external power supply (all phases) used in the system before wiring.
Failure to do so may result in electric shock or damage to the product.
- After wiring, attach the included terminal cover to the module before turning it on for operation.
Failure to do so may result in electric shock.

CAUTION

- Individually ground the FG and LG terminals of the programmable controller with a ground resistance of 100Ω or less.
Failure to do so may result in electric shock or malfunction.
- Use applicable solderless terminals and tighten them within the specified torque range.
If any spade solderless terminal is used, it may be disconnected when the terminal screw comes loose, resulting in failure.
- Check the rated voltage and terminal layout before wiring to the module, and connect the cables correctly.
Connecting a power supply with a different voltage rating or incorrect wiring may cause a fire or failure.
- Connectors for external devices must be crimped or pressed with the tool specified by the manufacturer, or must be correctly soldered.
Incomplete connections may cause short circuit, fire, or malfunction.
- Tighten the terminal screws within the specified torque range.
Undertightening can cause short circuit, fire, or malfunction.
Overtightening can damage the screw and/or module, resulting in drop, short circuit, or malfunction.
- Prevent foreign matter such as dust or wire chips from entering the module.
Such foreign matter can cause a fire, failure, or malfunction.
- A protective film is attached to the top of the module to prevent foreign matter, such as wire chips, from entering the module during wiring.
Do not remove the film during wiring.
Remove it for heat dissipation before system operation.
- Mitsubishi programmable controllers must be installed in control panels.
Connect the main power supply to the power supply module in the control panel through a relay terminal block.
Wiring and replacement of a power supply module must be performed by qualified maintenance personnel with knowledge of protection against electric shock.
For wiring methods, refer to the QCPU User's Manual (Hardware Design, Maintenance and Inspection).

[Startup and Maintenance Precautions]

WARNING

- Do not touch any terminal while power is on.
Doing so will cause electric shock.
- Correctly connect the battery connector.
Do not charge, disassemble, heat, short-circuit, or solder the battery, or throw it into the fire.
Doing so will cause the battery to produce heat, explode, or ignite, resulting in injury and fire.
- Shut off the external power supply (all phases) used in the system before cleaning the module or retightening the terminal screws or module fixing screws.
Failure to do so may result in electric shock.
Undertightening the terminal screws can cause short circuit or malfunction.
Overtightening can damage the screw and/or module, resulting in drop, short circuit, or malfunction.

CAUTION

- Before performing online operations (especially, program modification, forced output, and operating status change) for the running CPU module from the peripheral device connected, read relevant manuals carefully and ensure the safety.
Improper operation may damage machines or cause accidents.
- Do not disassemble or modify the modules.
Doing so may cause failure, malfunction, injury, or a fire.
- Use any radio communication device such as a cellular phone or PHS (Personal Handy-phone System) more than 25cm away in all directions from the programmable controller.
Failure to do so may cause malfunction.
- Shut off the external power supply (all phases) used in the system before mounting or removing a module. Failure to do so may cause the module to fail or malfunction.
A module can be replaced online (while power is on) on any MELSECNET/H remote I/O station or in the system where a CPU module supporting the online module change function is used.
Note that there are restrictions on the modules that can be replaced online, and each module has its predetermined replacement procedure.
For details, refer to this manual and the online module change section in the manual of the module compatible with online module change.
- After the first use of the product, do not mount/remove the module to/from the base unit, and the terminal block to/from the module more than 50 times (IEC 61131-2 compliant) respectively.
Exceeding the limit of 50 times may cause malfunction.
- Do not drop or apply shock to the battery to be installed in the module.
Doing so may damage the battery, causing the battery fluid to leak inside the battery.
If the battery is dropped or any shock is applied to it, dispose of it without using.
- Before handling the module, touch a conducting object such as a grounded metal to discharge the static electricity from the human body.
Failure to do so may cause the module to fail or malfunction.

[Disposal Precautions]

CAUTION

- When disposing of this product, treat it as industrial waste.
When disposing of batteries, separate them from other wastes according to the local regulations.
For details on battery regulations in EU member states, refer to the MELSEC-L CPU Module User's Manual (Hardware Design, Maintenance and Inspection).

[Transportation Precautions]

CAUTION

- When transporting lithium batteries, follow the transportation regulations.
(Refer to QCPU User's Manual (Hardware Design, Maintenance and Inspection) for details of the controlled models.)

● CONDITIONS OF USE FOR THE PRODUCT ●

- (1) Mitsubishi programmable controller ("the PRODUCT") shall be used in conditions;
- i) where any problem, fault or failure occurring in the PRODUCT, if any, shall not lead to any major or serious accident; and
 - ii) where the backup and fail-safe function are systematically or automatically provided outside of the PRODUCT for the case of any problem, fault or failure occurring in the PRODUCT.

- (2) The PRODUCT has been designed and manufactured for the purpose of being used in general industries. MITSUBISHI SHALL HAVE NO RESPONSIBILITY OR LIABILITY (INCLUDING, BUT NOT LIMITED TO ANY AND ALL RESPONSIBILITY OR LIABILITY BASED ON CONTRACT, WARRANTY, TORT, PRODUCT LIABILITY) FOR ANY INJURY OR DEATH TO PERSONS OR LOSS OR DAMAGE TO PROPERTY CAUSED BY the PRODUCT THAT ARE OPERATED OR USED IN APPLICATION NOT INTENDED OR EXCLUDED BY INSTRUCTIONS, PRECAUTIONS, OR WARNING CONTAINED IN MITSUBISHI'S USER, INSTRUCTION AND/OR SAFETY MANUALS, TECHNICAL BULLETINS AND GUIDELINES FOR the PRODUCT.

("Prohibited Application")

Prohibited Applications include, but not limited to, the use of the PRODUCT in;

- Nuclear Power Plants and any other power plants operated by Power companies, and/or any other cases in which the public could be affected if any problem or fault occurs in the PRODUCT.
- Railway companies or Public service purposes, and/or any other cases in which establishment of a special quality assurance system is required by the Purchaser or End User.
- Aircraft or Aerospace, Medical applications, Train equipment, transport equipment such as Elevator and Escalator, Incineration and Fuel devices, Vehicles, Manned transportation, Equipment for Recreation and Amusement, and Safety devices, handling of Nuclear or Hazardous Materials or Chemicals, Mining and Drilling, and/or other applications where there is a significant risk of injury to the public or property.

Notwithstanding the above restrictions, Mitsubishi may in its sole discretion, authorize use of the PRODUCT in one or more of the Prohibited Applications, provided that the usage of the PRODUCT is limited only for the specific applications agreed to by Mitsubishi and provided further that no special quality assurance or fail-safe, redundant or other safety features which exceed the general specifications of the PRODUCTS are required. For details, please contact the Mitsubishi representative in your region.

REVISIONS

* The handbook number is given on the bottom left of the back cover.

Print Date	* Handbook Number	Revision
Nov. 2011	L(NA)08220ENG-A	First edition
Mar. 2013	L(NA)08220ENG-B	<p>Model addition</p> <p>QD73A1</p> <p>Model change</p> <p>QD75P□ → QD75P□N, QD75D□ → QD75D□N</p> <p>Addition</p> <p>Section 7.4</p> <p>Partial correction</p> <p>Section 7.1, 7.2</p>
Jun. 2013	L(NA)08220ENG-C	<p>Partial correction</p> <p>Section 5.5.4, 7.1, 7.3.4, 7.4.4, 7.4.6</p>
Sep. 2014	L(NA)08220ENG-D	<p>Model addition</p> <p>Q64AD2DA</p> <p>Addition</p> <p>Chapter 4</p> <p>Partial correction</p> <p>Section 2.1, 3.1, 5.1, 6.1, 7.1, 8.1, 8.3.5, 9.1, 10.1, Appendix 2.1, 2.3</p>
May 2015	L(NA)08220ENG-E	<p>Change</p> <p>Chapter 11 to Appendix 1, Appendix 1 to Appendix 2, Appendix 2 to Appendix 3, Appendix 3 to Appendix 4</p> <p>Partial correction</p> <p>Section 3.1, SAFETY PRECAUTIONS, GENERIC TERMS AND ABBREVIATIONS</p>
Feb. 2016	L(NA)08220ENG-F	<p>Partial correction</p> <p>Cover, Section 9.1, WARRANTY</p>
Jul. 2018	L(NA)08220ENG-G	<p>Partial correction</p> <p>Cover, GENERIC TERMS AND ABBREVIATIONS, Section 1.1, 2.1, 7.2.1, 8.1, 8.2.1, 8.2.2, 8.3.1, 8.3.2, 8.3.5, 8.4.2, Chapter 10, Appendix 3.1, 3.4</p>

Japanese Handbook Version L-08208-H

This handbook confers no industrial property rights or any rights of any other kind, nor does it confer any patent licenses. Mitsubishi Electric Corporation cannot be held responsible for any problems involving industrial property rights which may occur as a result of using the contents noted in this handbook.

© 2011 MITSUBISHI ELECTRIC CORPORATION

CONTENTS

SAFETY PRECAUTIONS	A - 1
CONDITIONS OF USE FOR THE PRODUCT	A - 7
REVISIONS	A - 8
GENERIC TERMS AND ABBREVIATIONS	A - 14

CHAPTER 1 INTRODUCTION 1 - 1 to 1 - 2

1.1 Advantages of Transition to Q Series	1 - 1
1.2 Precautions for Transition from AnS/QnAS Series to Q Series	1 - 2

CHAPTER 2 ANALOG INPUT MODULE REPLACEMENT 2 - 1 to 2 - 26

2.1 List of Analog Input Module Alternative Models for Replacement	2 - 1
2.2 A1S64AD	2 - 3
2.2.1 Performance specifications comparison	2 - 3
2.2.2 Functional comparison	2 - 7
2.2.3 I/O signal comparison	2 - 8
2.2.4 Buffer memory address comparison	2 - 9
2.3 A1S68AD (Replacing with the Q68ADV or Q68ADI)	2 - 11
2.3.1 Performance specifications comparison	2 - 11
2.3.2 Functional comparison	2 - 15
2.3.3 I/O signal comparison	2 - 16
2.3.4 Buffer memory address comparison	2 - 17
2.4 A1S68AD (Replacing with the Q68AD-G)	2 - 19
2.4.1 Performance specifications comparison	2 - 19
2.4.2 Functional comparison	2 - 23
2.4.3 I/O signal comparison	2 - 24
2.4.4 Buffer memory address comparison	2 - 25

CHAPTER 3 ANALOG OUTPUT MODULE REPLACEMENT 3 - 1 to 3 - 35

3.1 List of Analog Output Module Alternative Models for Replacement	3 - 1
3.2 A1S62DA (Replacing with the Q62DAN)	3 - 3
3.2.1 Performance specifications comparison	3 - 3
3.2.2 Functional comparison	3 - 7
3.2.3 I/O signal comparison	3 - 8
3.2.4 Buffer memory address comparison	3 - 9
3.3 A1S62DA (Replacing with the Q64DAN)	3 - 11
3.3.1 Performance specifications comparison	3 - 11
3.3.2 Functional comparison	3 - 15
3.3.3 I/O signal comparison	3 - 16
3.3.4 Buffer memory address comparison	3 - 17
3.4 A1S68DAI	3 - 19
3.4.1 Performance specifications comparison	3 - 19
3.4.2 Functional comparison	3 - 23

3.4.3	I/O signal comparison	3 - 24
3.4.4	Buffer memory address comparison	3 - 25
3.5	A1S68DAV	3 - 27
3.5.1	Performance specifications comparison	3 - 27
3.5.2	Functional comparison	3 - 31
3.5.3	I/O signal comparison	3 - 32
3.5.4	Buffer memory address comparison	3 - 33

CHAPTER 4 ANALOG I/O MODULE REPLACEMENT

4 - 1 to 4 - 35

4.1	List of Analog I/O Module Alternative Models for Replacement	4 - 1
4.2	A1S63ADA	4 - 3
4.2.1	Performance specifications comparison	4 - 3
4.2.2	Functional comparison	4 - 6
4.2.3	I/O signal comparison	4 - 9
4.2.4	Buffer memory address comparison	4 - 10
4.3	A1S66ADA	4 - 19
4.3.1	Performance specifications comparison	4 - 19
4.3.2	Functional comparison	4 - 22
4.3.3	I/O signal comparison	4 - 25
4.3.4	Buffer memory address comparison	4 - 27

CHAPTER 5 TEMPERATURE INPUT MODULE REPLACEMENT

5 - 1 to 5 - 61

5.1	List of Temperature Input Module Alternative Models for Replacement	5 - 1
5.2	A1S68TD (Replacing with the Q64TD)	5 - 3
5.2.1	Performance specifications comparison	5 - 3
5.2.2	Functional comparison	5 - 7
5.2.3	I/O signal comparison	5 - 8
5.2.4	Buffer memory address comparison	5 - 9
5.3	A1S68TD (Replacing with the Q68TD-G-H02 or Q68TD-G-H01)	5 - 13
5.3.1	Performance specifications comparison	5 - 13
5.3.2	Functional comparison	5 - 18
5.3.3	I/O signal comparison	5 - 19
5.3.4	Buffer memory address comparison	5 - 20
5.4	A1S62RD3N (Replacing with the Q64RD)	5 - 23
5.4.1	Performance specifications comparison	5 - 23
5.4.2	Functional comparison	5 - 27
5.4.3	I/O signal comparison	5 - 28
5.4.4	Buffer memory address comparison	5 - 29
5.5	A1S62RD3N (Replacing with the Q64RD-G)	5 - 33
5.5.1	Performance specifications comparison	5 - 33
5.5.2	Functional comparison	5 - 37
5.5.3	I/O signal comparison	5 - 38
5.5.4	Buffer memory address comparison	5 - 39
5.6	A1S62RD4N (Replacing with the Q64RD)	5 - 43
5.6.1	Performance specifications comparison	5 - 43

5.6.2	Functional comparison	5 - 47
5.6.3	I/O signal comparison	5 - 48
5.6.4	Buffer memory address comparison	5 - 49
5.7	A1S62RD4N (Replacing with the Q64RD-G)	5 - 53
5.7.1	Performance specifications comparison	5 - 53
5.7.2	Functional comparison	5 - 57
5.7.3	I/O signal comparison	5 - 58
5.7.4	Buffer memory address comparison	5 - 59

CHAPTER 6 HEATING-COOLING TEMPERATURE CONTROL MODULE/ TEMPERATURE CONTROL MODULE REPLACEMENT 6 - 1 to 6 - 53

6.1	List of Heating-cooling Temperature Control Module/Temperature Control Module Alternative Models for Replacement	6 - 1
6.2	Performance Specifications Comparison	6 - 4
6.2.1	A1S64TCTRT(BW) (thermocouple connection)	6 - 4
6.2.2	A1S64TCTRT(BW) (platinum resistance thermometer connection)	6 - 8
6.2.3	A1S64TCTT(BW)-S1	6 - 12
6.2.4	A1S64TCRT(BW)-S1 (platinum resistance thermometer connection)	6 - 16
6.2.5	A1S62TCTT(BW)-S2	6 - 20
6.2.6	A1S62TCRT(BW)-S2	6 - 24
6.3	Functional Comparison	6 - 28
6.4	I/O Signal Comparison	6 - 30
6.4.1	A1S64TCTRT(BW) and Q series modules (standard control)	6 - 30
6.4.2	A1S64TCTRT(BW) and Q series modules (heating-cooling control)	6 - 32
6.4.3	A1S64TCTT(BW)-S1/A1S64TCRT(BW)-S1 and Q series modules	6 - 34
6.4.4	A1S62TCTT(BW)-S2/A1S62TCRT(BW)-S2 and Q series modules	6 - 36
6.5	Buffer Memory Address Comparison	6 - 38
6.5.1	A1S64TCTRT(BW) and Q series modules (standard control)	6 - 38
6.5.2	A1S64TCTRT(BW) and Q series modules (heating-cooling control)	6 - 42
6.5.3	A1S64TCTT(BW)-S1/A1S64TCRT(BW)-S1 and Q series modules	6 - 46
6.5.4	A1S62TCTT(BW)-S2/A1S62TCRT(BW)-S2 and Q series modules	6 - 50

CHAPTER 7 HIGH-SPEED COUNTER MODULE REPLACEMENT 7 - 1 to 7 - 26

7.1	List of High-Speed Counter Module Alternative Models for Replacement	7 - 1
7.2	A1SD61	7 - 5
7.2.1	Performance specifications comparison	7 - 5
7.2.2	Functional comparison	7 - 11
7.2.3	I/O signal comparison	7 - 12
7.2.4	Buffer memory address comparison	7 - 14
7.3	A1SD62(E/D/D-S1)	7 - 15
7.3.1	Performance specifications comparison	7 - 15
7.3.2	Functional comparison	7 - 23
7.3.3	I/O signal comparison	7 - 24
7.3.4	Buffer memory address comparison	7 - 26

CHAPTER 8 POSITIONING MODULE REPLACEMENT		8 - 1 to 8 - 55
8.1	List of Positioning Module Alternative Models for Replacement	8 - 1
8.2	A1SD75P1-S3/P2-S3/P3-S3	8 - 3
8.2.1	Performance specifications comparison	8 - 3
8.2.2	Functional comparison	8 - 8
8.2.3	I/O signal comparison	8 - 11
8.2.4	Buffer memory address comparison	8 - 12
8.2.5	External interface specifications comparison	8 - 20
8.3	A1SD75M1/M2/M3	8 - 21
8.3.1	Performance specifications comparison	8 - 21
8.3.2	Functional comparison	8 - 25
8.3.3	I/O signal comparison	8 - 28
8.3.4	Buffer memory address comparison	8 - 29
8.3.5	External interface specifications comparison	8 - 41
8.4	A1SD70	8 - 44
8.4.1	Performance specifications comparison	8 - 44
8.4.2	Function comparison	8 - 46
8.4.3	I/O signals comparison	8 - 50
8.4.4	Buffer memory address comparison	8 - 51
8.4.5	Interface specifications comparison with external devices	8 - 53
8.4.6	Precautions for the replacement of the A1SD70 by the QD73A1	8 - 54
CHAPTER 9 POSITION DETECTION MODULE REPLACEMENT		9 - 1 to 9 - 2
9.1	Position Detection Module Replacement	9 - 1
CHAPTER 10 REPLACEMENT OF OTHER MODULES		10 - 1 to 10 - 2
10.1	Replacement of Other Modules	10 - 1
APPENDICES		App - 1 to App - 8
Appendix 1	External Dimensions	App - 1
Appendix 2	Spare Parts Storage	App - 2
Appendix 3	Relevant Manuals	App - 3
Appendix 3.1	Replacement handbooks	App - 3
Appendix 3.2	AnS series	App - 4
Appendix 3.3	Q series	App - 5
Appendix 3.4	Programming tool	App - 6
Appendix 4	How to Change Resolution After Analog I/O Module is Replaced	App - 7

- For the products shown in handbooks for transition, catalogues, and transition examples, refer to the manuals for the relevant products and check the detailed specifications, precautions for use, and restrictions before replacement.

For the products manufactured by Mitsubishi Electric Engineering Co., Ltd., Mitsubishi Electric System & Service Co., Ltd., and other companies, refer to the catalogue for each product and check the detailed specifications, precautions for use, and restrictions before use.

The manuals and catalogues for our products, products manufactured by Mitsubishi Electric Engineering Co., Ltd., and Mitsubishi Electric System & Service Co., Ltd. are shown in Appendix of each handbook for transition.

- Products shown in this handbook are subject to change without notice.

GENERIC TERMS AND ABBREVIATIONS

Unless otherwise specified, this handbook uses the following generic terms and abbreviations.

Generic term/abbreviation	Description
■Series	
A series	An abbreviation for large types of Mitsubishi Electric MELSEC-A series programmable controllers
AnS series	An abbreviation for compact types of Mitsubishi Electric MELSEC-A series programmable controllers
A/AnS series	Generic term for A series and AnS series
QnA series	An abbreviation for large types of Mitsubishi Electric MELSEC-QnA series programmable controllers
QnAS series	An abbreviation for compact types of Mitsubishi Electric MELSEC-QnA series programmable controllers
QnA/QnAS series	Generic term for QnA series and QnAS series
A/AnS/QnA/QnAS series	Generic term for A series, AnS series, QnA series, and QnAS series
Q series	An abbreviation for Mitsubishi Electric MELSEC-Q series programmable controllers
■CPU module type	
CPU module	Generic term for A series, AnS series, QnA series, QnAS series, and Q series CPU modules
Process CPU	Generic term for the Q02PHCPU, Q06PHCPU, Q12PHCPU, and Q25PHCPU
Redundant CPU	Generic term for the Q12PRHCPU and Q25PRHCPU
Universal model QCPU	Generic term for the Q00UJCPU, Q00UCPU, Q01UCPU, Q02UCPU, Q03UDCPU, Q03UDVCPU, Q03UDECPU, Q04UDHCPU, Q04UDVCPU, Q04UDEHCPU, Q06UDHCPU, Q06UDVCPU, Q06UDEHCPU, Q10UDHCPU, Q10UDEHCPU, Q13UDHCPU, Q13UDVCPU, Q13UDEHCPU, Q20UDHCPU, Q20UDEHCPU, Q26UDHCPU, Q26UDVCPU, and Q26UDEHCPU
■CPU module model	
ACPU	Generic term for MELSEC-A series programmable controller CPUs
AnSCPU	Generic term for MELSEC-AnS series programmable controller CPUs
AnNCP	Generic term for the A1NCP, A1NCPUP21/R21, A1NCPUP21-S3, A2NCP, A2NCP-S1, A2NCPUP21/R21, A2NCPUP21/R21-S1, A2NCPUP21-S3(S4), A3NCP, A3NCPUP21/R21, and A3NCPUP21-S3
AnACPU	Generic term for the A2ACPU, A2ACPU-S1, A3ACPU, A2ACPUP21/R21, A2ACPUP21/R21-S1, and A3ACPUP21/R21
AnUCPU	Generic term for the A2UCPU, A2UCPU-S1, A3UCPU, A4UCPU, A2USCPU, A2USCPU-S1, and A2USHCPU-S1
AnUS(H)CPU	Generic term for the A2USCPU, A2USCPU-S1, A2USHCPU-S1
A/AnSCPU	Generic term for MELSEC-A series and MELSEC-AnS series programmable controller CPUs
AnN/AnACPU	Generic term for the AnNCP and AnACPU
AnN/AnA/AnSCPU	Generic term for the AnNCP, AnACPU, and AnSCPU
QnACPU	Generic term for MELSEC-QnA series programmable controller CPUs
QnASCPU	Generic term for MELSEC-QnAS series programmable controller CPUs
QnA/QnASCPU	Generic term for MELSEC-QnA series and MELSEC-QnAS series programmable controller CPUs
A/AnS/QnA/QnASCPU	Generic term for A series, AnS series, QnA series, and QnAS series programmable controller CPUs
QCPU	Generic term for MELSEC-Q series programmable controller CPUs

1 INTRODUCTION

1.1 Advantages of Transition to Q Series

Advantage 1)Advanced performance of equipments

In addition to the processing performance improvement for Q series CPU, the processing speed for Q series intelligent function module is also increased, so that the equipment capability to improve is possible.

Advantage 2)Compact control panel and space saving

As the Q series needs only 1/4 mounting area of the AnS/QnAS series, it is possible to create more compact control panel.

Advantage 3)Improved operating efficiency for programming and monitor

With the Q series intelligent function module, you can easily set, monitor, and test the intelligent function module using GX Works2 without changing the parameter settings, auto refresh, I/O signals, and buffer memory.

- Parameter setting is possible without a program.
- The auto refresh setting allows to read/write buffer memory data of intelligent function module automatically from/to the CPU device memory.
- Checking of the setting status or operating status of intelligent function module is simplified.

Please note that equivalent functions are available using a separately sold utility package (GX Configurator-□) in GX Developer.

1.2 Precautions for Transition from AnS/QnAS Series to Q Series

- (1) Be sure to confirm its functions, specifications and instructions by referring the manual of the corresponding Q series module prior to use.
- (2) Be sure to check the operation of whole system before the actual operation.

2 ANALOG INPUT MODULE REPLACEMENT

2.1 List of Analog Input Module Alternative Models for Replacement

AnS/QnAS series		Transition to Q series	
Product	Model	Model	Remarks (Restrictions)
Analog input module	A1S64AD	Q64AD	1) External wiring : Cable size is changed. 2) Number of slots : Not changed 3) Program : The number of occupied I/O points, I/O signals, and buffer memory addresses are changed. 4) Performance specifications: Not changed 5) Functional specifications: Not changed
	A1S68AD	Q68ADV Q68ADI	1) External wiring : Cable size is changed. 2) Number of slots : Not changed 3) Program : The number of occupied I/O points, I/O signals, and buffer memory addresses are changed. 4) Performance specifications: Input signals (either V or I input) and I/O characteristics are changed. 5) Functional specifications: Not changed
		Q68AD-G ^{*1}	1) External wiring : Cable size is changed. 2) Number of slots : Not changed 3) Program : The number of occupied I/O points, I/O signals, and buffer memory addresses are changed. 4) Performance specifications: Changed. Conversion speed (0.5ms/channel) → sampling cycle (10ms/channel) + response speed (20ms) 5) Functional specifications: Changed (Non-insulation → insulation between channels)

*1 The Q68AD-G cannot be mounted on the Q series large type base unit (Q3□BL, Q6□BL, Q55BL).

☒ Point

The existing wiring for the AnS/QnAS series modules can be connected directly to the Q series modules using the upgrade tool (conversion adaptor) manufactured by Mitsubishi Electric Engineering Co., Ltd.

Product	MELSEC-AnS/QnAS series module	MELSEC-Q series module	Conversion adaptor
Analog input module	A1S64AD	Q64AD	ERNT-ASQT64AD
	A1S68AD (voltage input)	Q68ADV	ERNT-ASQT68AD
	A1S68AD (current input)	Q68ADI	
	A1S68AD	Q68AD-G	ERNT-ASQT68AD-G ^{*1}

*1 Conversion adapter with fixture, which cannot be mounted on the AnS size version Q large type base unit.
Before using the conversion adapter with fixture, be sure to fasten its fixture to the base adapter or DIN rail mounting bracket using screws.

For MELSEC-AnS/QnAS (small type) series to Q series transition related products manufactured by Mitsubishi Electric Engineering Co., Ltd. or Mitsubishi Electric System & Service Co., Ltd., contact your local sales office or representative.

2.2 A1S64AD

2.2.1 Performance specifications comparison

Item		A1S64AD																																			
Analog input	Voltage	-10 to 0 to +10VDC (Input resistance value: 1MΩ)																																			
	Current	-20 to 0 to +20mADC (Input resistance value: 250Ω)																																			
Digital output		16-bit signed binary When 1/4000 is set: -4096 to +4095 When 1/8000 is set: -8192 to +8191 When 1/12000 is set: -12288 to +12287																																			
I/O characteristics		<table border="1"> <thead> <tr> <th>Item</th> <th colspan="4">Specifications</th> </tr> <tr> <th rowspan="2">I/O characteristics</th> <th rowspan="2">Analog input</th> <th colspan="3">Digital output value (when gain 5V/20mA, offset 0V/0mA)</th> </tr> <tr> <th>1/4000</th> <th>1/8000</th> <th>1/12000</th> </tr> </thead> <tbody> <tr> <td>+10V</td> <td>+4000</td> <td>+8000</td> <td>+12000</td> </tr> <tr> <td>+5V or +20mA</td> <td>+2000</td> <td>+4000</td> <td>+6000</td> </tr> <tr> <td>0V or 0mA</td> <td>0</td> <td>0</td> <td>0</td> </tr> <tr> <td>-5V or -20mA</td> <td>-2000</td> <td>-4000</td> <td>-6000</td> </tr> <tr> <td>-10V</td> <td>-4000</td> <td>-8000</td> <td>-12000</td> </tr> </tbody> </table>			Item	Specifications				I/O characteristics	Analog input	Digital output value (when gain 5V/20mA, offset 0V/0mA)			1/4000	1/8000	1/12000	+10V	+4000	+8000	+12000	+5V or +20mA	+2000	+4000	+6000	0V or 0mA	0	0	0	-5V or -20mA	-2000	-4000	-6000	-10V	-4000	-8000	-12000
Item	Specifications																																				
I/O characteristics	Analog input	Digital output value (when gain 5V/20mA, offset 0V/0mA)																																			
		1/4000	1/8000	1/12000																																	
+10V	+4000	+8000	+12000																																		
+5V or +20mA	+2000	+4000	+6000																																		
0V or 0mA	0	0	0																																		
-5V or -20mA	-2000	-4000	-6000																																		
-10V	-4000	-8000	-12000																																		
Maximum resolution		<table border="1"> <thead> <tr> <th rowspan="3">Maximum resolution</th> <th>Analog input</th> <td>1/4000</td> <td>1/8000</td> <td>1/12000</td> </tr> <tr> <th>Voltage input</th> <td>2.5mV</td> <td>1.25mV</td> <td>0.83mV</td> </tr> <tr> <th>Current input</th> <td>10μA</td> <td>5μA</td> <td>3.33μA</td> </tr> </thead> </table>			Maximum resolution	Analog input	1/4000	1/8000	1/12000	Voltage input	2.5mV	1.25mV	0.83mV	Current input	10μA	5μA	3.33μA																				
Maximum resolution	Analog input	1/4000	1/8000	1/12000																																	
	Voltage input	2.5mV	1.25mV	0.83mV																																	
	Current input	10μA	5μA	3.33μA																																	
Overall accuracy (Accuracy in respect to maximum digital output value)		±1% When 1/4000 is set: ±40 When 1/8000 is set: ±80 When 12000 is set: ±120																																			

○ : Compatible, △ : Partial change required, × : Incompatible

		Q64AD				Compatibil-ity	Precautions for replacement				
		-10 to 10VDC (Input resistance value: 1MΩ)				○					
		0 to 20mADC (Input resistance value: 250Ω)									
		16-bit signed binary (Normal resolution mode: -4096 to 4095, High resolution mode: -12288 to 12287, -16384 to 16383)				○					
	Analog input range		Normal resolution mode		High resolution mode		△	If the resolution differs between AnS series and Q series modules, it needs to be matched using a sequence program or user range settings. (Refer to Appendix 4.)			
			Digital output value	Maximum resolution	Digital output value	Maximum resolution					
	Voltage	0 to 10V	0 to 4000	2.5mV	0 to 16000	0.625mV					
		0 to 5V		1.25mV		0 to 12000			0.416mV		
		1 to 5V		1.0mV	0.333mV						
		-10 to 10V	-4000 to 4000	2.5mV	-16000 to 16000	0.625mV					
	User range settings	0.375mV		-12000 to 12000	0.333mV						
	Current	0 to 20mA	0 to 4000	5μA	0 to 12000	1.66μA					
		4 to 20mA		4μA		1.33μA					
		User range settings	-4000 to 4000	1.37μA	-12000 to 12000	1.33μA					
Analog input range		Normal resolution mode			High resolution mode			○			
		Ambient temperature 0 to 55°C		Ambient temperature 25±5°C	Ambient temperature 0 to 55°C		Ambient temperature 25±5°C				
Voltage	With temperature drift compensation	Without temperature drift compensation	±0.1% (±4 digits)		With temperature drift compensation	Without temperature drift compensation					
	0 to 10V	±0.3% (±12 digits)		±0.4% (±16 digits)	±0.3% (±48 digits)	±0.4% (±64 digits)	±0.1% (±16 digits)				
	-10 to 10V				±0.3% (±12 digits)	±0.4% (±16 digits)	±0.1% (±4 digits)		±0.3% (±36 digits)	±0.4% (±48 digits)	±0.1% (±12 digits)
	0 to 5V										
1 to 5V											
User range settings											
Current	0 to 20mA	±0.3% (±12 digits)	±0.4% (±16 digits)	±0.1% (±4 digits)	±0.3% (±36 digits)	±0.4% (±48 digits)	±0.1% (±12 digits)				
	4 to 20mA										
	User range settings										

Item	A1S64AD	
Maximum conversion speed	20ms/channel	
Absolute maximum input	Voltage: ±15V Current: ±30mA	
Analog input points	4 channels/module	
Maximum number of writes for E ² PROM	-	
Isolation method	Between the input terminal and programmable controller power supply: photocoupler isolation Between channels: not isolated	
Dielectric withstand voltage	Between the input terminal and programmable controller power supply: 500VAC, for 1 minute	
Insulation resistance	Between the input terminal and programmable controller power supply: 500VDC, 5MΩ or more	
Number of occupied I/O points	32 points (I/O assignment: special 32 points)	
Connected terminal	20-point terminal block	
Applicable wire size	0.75 to 1.5mm ² (Applicable tightening torque: 39 to 59N·cm)	
Applicable solderless terminal	1.25-3, 1.25-YS3, V1.25-3, V1.25-YS3A	
Internal current consumption (5VDC)	0.40A	
Weight	0.25kg	

○ : Compatible, △ : Partial change required, × : Incompatible

	Q64AD	Compatibil-ity	Precautions for replacement
	80μs/channel (When there is temperature drift compensation, the time calculated by adding 160μs will be used regardless of the number of channels used.)	○	The conversion speed of Q64AD to A1S64AD has become quick. And then, on A1S64AD, the noise that did not import on A1S64AD can be imported as analog signal. In this case, use the averaging processing function to remove the effect of noise.
	Voltage: ±15V Current: ±30mA	○	
	4 channels/module	○	
	Max. 100,000 times	○	
	Between the I/O terminal and programmable controller power supply: photocoupler isolation Between channels: not isolated	○	
	Between the I/O terminal and programmable controller power supply: 500VAC, for 1 minute	○	
	Between the I/O terminal and programmable controller power supply: 500VDC, 20MΩ or more	○	
	16 points (I/O assignment: intelligent 16 points)	△	The number of occupied I/O points has changed to 16 points.
	18-point terminal block	×	Wiring change is required.
	0.3 to 0.75mm ²	×	
	R1.25-3 (Solderless terminals with an insulation sleeve cannot be used.)	×	
	0.63A	△	Recalculation of internal current consumption (5VDC) is required.
	0.18kg	△	

2.2.2 Functional comparison

○ : Available, - : Not available

Item	Description	A1S64AD	Q64AD	Precautions for replacement
A/D conversion enable/disable	Specifies whether to enable or disable the A/D conversion. By disabling the conversion for the channels that are not used, the sampling time can be shortened.	○	○	
Sampling processing	The A/D conversion for analog input values is performed successively for each channel, and the digital output value is output upon each conversion.	○	○	The sampling processing time changes depending on the number of channels used (number of channels set to A/D conversion enable) and whether, with or without the temperature drift compensation function. (a) Without temperature drift compensation function (processing time) = (number of channels used) × 80 (μs/1 channel) (b) With temperature drift compensation function (processing time) = (number of channels used) × 80 (μs/1 channel) + 160μs
Averaging processing	For each channel, A/D conversion values are averaged for the set number of times or set amount of time, and the average value is output as a digital value.	○	○	The setting range of average time and count differ. Check the specifications, referring to the Analog-Digital Converter Module User's Manual.
Maximum and minimum values hold function	The maximum and minimum values of the digital output values are retained in the module.	-	○	
Temperature drift compensation function	Errors arising from changes in the ambient temperature of the module are automatically compensated to improve conversion accuracy. The temperature drift compensation function can be performed at (A/D conversion time for all channels) + 160μs.	-	○	
Resolution mode	The resolution can be switched according to the application. The resolution mode setting is applicable to all channels.*1	○	○	
Online module change	A module can be replaced without the system being stopped.	-	○	The Process CPU and Redundant CPU support this function.

*1 For the A1S64AD, the resolution for both voltage and current can be selected from 1/4000, 1/8000, or 1/12000.
For the Q64AD, the resolution for both voltage and current is 1/4000 in normal resolution mode. In high resolution mode, the resolution for the voltage range -10 to 0 to 10V is 1/16000, and the resolution for the voltage in other ranges and current is 1/12000.

2.2.3 I/O signal comparison

Sequence program change is required as the I/O signals differ.

For details of the I/O signals or sequence program, refer to the Analog-Digital Converter Module User's Manual.

A1S64AD				Q64AD				
Device No.	Signal name	Device No.	Signal name	Device No.	Signal name	Device No.	Signal name	
X0	Watchdog timer error	Y0	Use prohibited	X0	Module READY	Y0	Use prohibited	
X1	A/D conversion READY	Y1		X1	Temperature drift compensation flag	Y1		
X2	Error flag	Y2		Use prohibited	X2	Use prohibited		Y2
X3	Use prohibited	Y3			Y3			
X4		Y4			Y4			
X5		Y5			Y5			
X6		Y6			Y6			
X7		Y7			Y7			
X8		Use prohibited		Y8	X8	High resolution mode status flag		Y8
X9	Y9			X9	Operating condition setting completed flag	Y9		Operating condition setting request
XA	YA			XA	Offset/gain setting mode flag	YA		User range writing request
XB	YB			XB	Channel change completed flag	YB		Channel change request
XC	YC		XC	Use prohibited	YC	Use prohibited		
XD	YD		XD	Maximum value/minimum value reset completed flag	YD	Maximum value/minimum value reset request		
XE	Use prohibited		YE	XE	A/D conversion completed flag	YE	Use prohibited	
XF	Use prohibited		YF	XF	Error flag	YF	Error clear request	
X10			Y10	Error reset				
X11			Y11					
X12			Y12					
X13			Y13					
X14		Y14						
X15		Y15						
X16		Y16						
X17		Y17						
X18		Y18						
X19		Y19	Use prohibited					
X1A		Y1A						
X1B	Y1B							
X1C	Y1C							
X1D	Y1D							
X1E	Y1E							
X1F	Y1F							

2.2.4 Buffer memory address comparison

Sequence program change is required as the assignment of buffer memory differs.

For details of the buffer memory or sequence program, refer to the Analog-Digital Converter Module User's Manual.

A1S64AD			Q64AD			
Address (decimal)	Name	Read/write	Address (decimal)	Name	Read/write	
0	A/D conversion enable/disable setting	R/W	0	A/D conversion enable/disable setting	R/W	
1	Average processing specification		1	CH1 Average time/average number of times		
2	CH1 Average time, count		2	CH2 Average time/average number of times		
3	CH2 Average time, count		3	CH3 Average time/average number of times		
4	CH3 Average time, count		4	CH4 Average time/average number of times		
5	CH4 Average time, count	-	5	System area (Use prohibited)	-	
6	System area (Use prohibited)		6			6
7			7			
8			8			
9		9	Averaging processing setting	R/W		
10	CH1 Digital output value	R	10	A/D conversion completed flag	R	
11	CH2 Digital output value		11	CH1 Digital output value		
12	CH3 Digital output value		12	CH2 Digital output value		
13	CH4 Digital output value		13	CH3 Digital output value		
14	System area (Use prohibited)	-	14	CH4 Digital output value	-	
15			15	System area (Use prohibited)		
16			16			
17			17			
18	Write data error code	R	18	System area (Use prohibited)	-	
19	A-D conversion completed flag		19	Error code		
20	Resolution setting	R/W	20	Setting range (CH1 to CH4)	R	
			21	System area (Use prohibited)	-	
			22	Offset/gain setting mode Offset specification	R/W	
			23	Offset/gain setting mode Gain specification		
			24 to 29	System area (Use prohibited)	-	
			30	CH1 Maximum value	R	
			31	CH1 Minimum value		
			32	CH2 Maximum value		
			33	CH2 Minimum value		
			34	CH3 Maximum value		
			35	CH3 Minimum value		
			36	CH4 Maximum value		
			37	CH4 Minimum value		
			38 to 157	System area (Use prohibited)	-	
			158	Mode switching setting	R/W	
			159			
			160 to 199	System area (Use prohibited)	-	
			200	Pass data classification setting	R/W	
			201	System area (Use prohibited)	-	
			202	CH1 Industrial shipment settings offset value	R/W	
			203	CH1 Industrial shipment settings gain value		
			204	CH2 Industrial shipment settings offset value		
			205	CH2 Industrial shipment settings gain value		
			206	CH3 Industrial shipment settings offset value		
			207	CH3 Industrial shipment settings gain value		
			208	CH4 Industrial shipment settings offset value		
			209	CH4 Industrial shipment settings gain value		

Q64AD		
Address (decimal)	Name	Read/write
210	CH1 User range settings offset value	R/W
211	CH1 User range settings gain value	
212	CH2 User range settings offset value	
213	CH2 User range settings gain value	
214	CH3 User range settings offset value	
215	CH3 User range settings gain value	
216	CH4 User range settings offset value	
217	CH4 User range settings gain value	

2.3 A1S68AD (Replacing with the Q68ADV or Q68ADI)

2.3.1 Performance specifications comparison

Item		A1S68AD																									
Analog input	Voltage	-10 to 0 to +10VDC (Input resistance value: 1MΩ)																									
	Current	0 to +20mADC (Input resistance value: 250Ω)																									
Digital output		16-bit signed binary																									
I/O characteristics, maximum resolution		<p>I/O characteristics</p> <table border="1"> <thead> <tr> <th>Analog input</th> <th>Digital output</th> </tr> </thead> <tbody> <tr> <td>0 to +10V</td> <td>0 to +4000</td> </tr> <tr> <td>-10V to +10V</td> <td>-2000 to +2000</td> </tr> <tr> <td>0V to 5V or 0 to 20mA</td> <td>0 to +4000</td> </tr> <tr> <td>1 to 5V or 4 to 20mA</td> <td>0 to +4000</td> </tr> </tbody> </table> <p>Maximum resolution</p> <table border="1"> <thead> <tr> <th>Analog input</th> <th>Digital output</th> </tr> </thead> <tbody> <tr> <td>0 to +10V</td> <td>2.5mV</td> </tr> <tr> <td>-10V to +10V</td> <td>5mV</td> </tr> <tr> <td>0V to 5V</td> <td>1.25mV</td> </tr> <tr> <td>1 to 5V</td> <td>1mV</td> </tr> <tr> <td>0 to 20mA</td> <td>5μA</td> </tr> <tr> <td>4 to 20mA</td> <td>4μA</td> </tr> </tbody> </table>	Analog input	Digital output	0 to +10V	0 to +4000	-10V to +10V	-2000 to +2000	0V to 5V or 0 to 20mA	0 to +4000	1 to 5V or 4 to 20mA	0 to +4000	Analog input	Digital output	0 to +10V	2.5mV	-10V to +10V	5mV	0V to 5V	1.25mV	1 to 5V	1mV	0 to 20mA	5μA	4 to 20mA	4μA	
Analog input	Digital output																										
0 to +10V	0 to +4000																										
-10V to +10V	-2000 to +2000																										
0V to 5V or 0 to 20mA	0 to +4000																										
1 to 5V or 4 to 20mA	0 to +4000																										
Analog input	Digital output																										
0 to +10V	2.5mV																										
-10V to +10V	5mV																										
0V to 5V	1.25mV																										
1 to 5V	1mV																										
0 to 20mA	5μA																										
4 to 20mA	4μA																										
Overall accuracy		<p>Within ±1% at full scale (Digital output value: ±40)</p>																									

○ : Compatible, △ : Partial change required, × : Incompatible

		Q68ADV	Q68ADI	Compatibil-ity	Precautions for replacement																																													
		-10 to 10VDC (Input resistance value: 1MΩ)	-	△	The voltage/current cannot be mixed for one module.																																													
		-	0 to 20mADC (Input resistance value: 250Ω)																																															
16-bit signed binary (Normal resolution mode: -4096 to 4095, High resolution mode: -12288 to 12287, -16384 to 16383)				○																																														
		<table border="1"> <thead> <tr> <th rowspan="2">Analog input range</th> <th colspan="2">Normal resolution mode</th> <th colspan="2">High resolution mode</th> </tr> <tr> <th>Digital output value</th> <th>Maximum resolution</th> <th>Digital output value</th> <th>Maximum resolution</th> </tr> </thead> <tbody> <tr> <td rowspan="5">Voltage</td> <td>0 to 10V</td> <td rowspan="3">0 to 4000</td> <td>2.5mV</td> <td>0 to 16000</td> <td>0.625mV</td> </tr> <tr> <td>0 to 5V</td> <td>1.25mV</td> <td rowspan="2">0 to 12000</td> <td>0.416mV</td> </tr> <tr> <td>1 to 5V</td> <td>1.0mV</td> <td>0.333mV</td> </tr> <tr> <td>-10 to 10V</td> <td rowspan="2">-4000 to 4000</td> <td>2.5mV</td> <td>-16000 to 16000</td> <td>0.625mV</td> </tr> <tr> <td>User range settings</td> <td>0.375mV</td> <td>-12000 to 12000</td> <td>0.333mV</td> </tr> <tr> <td rowspan="3">Current</td> <td>0 to 20mA</td> <td rowspan="2">0 to 4000</td> <td>5μA</td> <td rowspan="2">0 to 12000</td> <td>1.66μA</td> </tr> <tr> <td>4 to 20mA</td> <td>4μA</td> <td>1.33μA</td> </tr> <tr> <td>User range settings</td> <td>-4000 to 4000</td> <td>1.37μA</td> <td>-12000 to 12000</td> <td>1.33μA</td> </tr> </tbody> </table>		Analog input range	Normal resolution mode		High resolution mode		Digital output value	Maximum resolution	Digital output value	Maximum resolution	Voltage	0 to 10V	0 to 4000	2.5mV	0 to 16000	0.625mV	0 to 5V	1.25mV	0 to 12000	0.416mV	1 to 5V	1.0mV	0.333mV	-10 to 10V	-4000 to 4000	2.5mV	-16000 to 16000	0.625mV	User range settings	0.375mV	-12000 to 12000	0.333mV	Current	0 to 20mA	0 to 4000	5μA	0 to 12000	1.66μA	4 to 20mA	4μA	1.33μA	User range settings	-4000 to 4000	1.37μA	-12000 to 12000	1.33μA	△	If the resolution differs between AnS series and Q series modules, it needs to be matched using a sequence program or user range settings. (Refer to Appendix 4.)
Analog input range	Normal resolution mode		High resolution mode																																															
	Digital output value	Maximum resolution	Digital output value	Maximum resolution																																														
Voltage	0 to 10V	0 to 4000	2.5mV	0 to 16000	0.625mV																																													
	0 to 5V		1.25mV	0 to 12000	0.416mV																																													
	1 to 5V		1.0mV		0.333mV																																													
	-10 to 10V	-4000 to 4000	2.5mV	-16000 to 16000	0.625mV																																													
	User range settings		0.375mV	-12000 to 12000	0.333mV																																													
Current	0 to 20mA	0 to 4000	5μA	0 to 12000	1.66μA																																													
	4 to 20mA		4μA		1.33μA																																													
	User range settings	-4000 to 4000	1.37μA	-12000 to 12000	1.33μA																																													
		<table border="1"> <thead> <tr> <th rowspan="3">Analog input range</th> <th colspan="3">Normal resolution mode</th> <th colspan="3">High resolution mode</th> </tr> <tr> <th colspan="2">Ambient temperature 0 to 55°C</th> <th rowspan="2">Ambient temperature 25±5°C</th> <th colspan="2">Ambient temperature 0 to 55°C</th> <th rowspan="2">Ambient temperature 25±5°C</th> </tr> <tr> <th>With temperature drift compensation</th> <th>Without temperature drift compensation</th> <th>With temperature drift compensation</th> <th>Without temperature drift compensation</th> </tr> </thead> <tbody> <tr> <td rowspan="4">Voltage</td> <td>0 to 10V</td> <td rowspan="4">±0.3% (±12 digits)</td> <td rowspan="4">±0.4% (±16 digits)</td> <td rowspan="4">±0.1% (±4 digits)</td> <td>±0.3% (±48 digits)</td> <td>±0.4% (±64 digits)</td> <td>±0.1% (±16 digits)</td> </tr> <tr> <td>-10 to 10V</td> <td rowspan="3">±0.3% (±36 digits)</td> <td rowspan="3">±0.4% (±48 digits)</td> <td rowspan="3">±0.1% (±12 digits)</td> </tr> <tr> <td>0 to 5V</td> </tr> <tr> <td>1 to 5V</td> </tr> <tr> <td>user range settings</td> <td></td> <td></td> <td></td> </tr> <tr> <td rowspan="3">Current</td> <td>0 to 20mA</td> <td rowspan="3">±0.3% (±12 digits)</td> <td rowspan="3">±0.4% (±16 digits)</td> <td rowspan="3">±0.1% (±4 digits)</td> <td>±0.3% (±36 digits)</td> <td>±0.4% (±48 digits)</td> <td>±0.1% (±12 digits)</td> </tr> <tr> <td>4 to 20mA</td> </tr> <tr> <td>user range settings</td> </tr> </tbody> </table>		Analog input range	Normal resolution mode			High resolution mode			Ambient temperature 0 to 55°C		Ambient temperature 25±5°C	Ambient temperature 0 to 55°C		Ambient temperature 25±5°C	With temperature drift compensation	Without temperature drift compensation	With temperature drift compensation	Without temperature drift compensation	Voltage	0 to 10V	±0.3% (±12 digits)	±0.4% (±16 digits)	±0.1% (±4 digits)	±0.3% (±48 digits)	±0.4% (±64 digits)	±0.1% (±16 digits)	-10 to 10V	±0.3% (±36 digits)	±0.4% (±48 digits)	±0.1% (±12 digits)	0 to 5V	1 to 5V	user range settings				Current	0 to 20mA	±0.3% (±12 digits)	±0.4% (±16 digits)	±0.1% (±4 digits)	±0.3% (±36 digits)	±0.4% (±48 digits)	±0.1% (±12 digits)	4 to 20mA	user range settings	○	
Analog input range	Normal resolution mode				High resolution mode																																													
	Ambient temperature 0 to 55°C		Ambient temperature 25±5°C		Ambient temperature 0 to 55°C		Ambient temperature 25±5°C																																											
	With temperature drift compensation	Without temperature drift compensation		With temperature drift compensation	Without temperature drift compensation																																													
Voltage	0 to 10V	±0.3% (±12 digits)	±0.4% (±16 digits)	±0.1% (±4 digits)	±0.3% (±48 digits)	±0.4% (±64 digits)	±0.1% (±16 digits)																																											
	-10 to 10V				±0.3% (±36 digits)	±0.4% (±48 digits)	±0.1% (±12 digits)																																											
	0 to 5V																																																	
	1 to 5V																																																	
user range settings																																																		
Current	0 to 20mA	±0.3% (±12 digits)	±0.4% (±16 digits)	±0.1% (±4 digits)	±0.3% (±36 digits)	±0.4% (±48 digits)	±0.1% (±12 digits)																																											
	4 to 20mA																																																	
	user range settings																																																	

Item	A1S68AD	
Maximum conversion speed	0.5ms/channel (The speed is 1ms/channel on all channels if averaging processing is set even for one channel.)	
Absolute maximum input	Voltage: ±35V Current: ±30mA	
Analog input points	8 channels/module	
Maximum number of writes for E ² PROM	-	
Isolation method	Between the input terminal and programmable controller power supply: photocoupler isolation Between channels: not isolated	
Dielectric withstand voltage	-	
Insulation resistance	-	
Number of occupied I/O points	32 points (I/O assignment: special 32 points)	
Connected terminal	20-point terminal block	
Applicable wire size	0.75 to 1.5mm ²	
Applicable solderless terminal	R1.25-3, 1.25-YS3, RAV1.25-3, V1.25-YS3A	
Internal current consumption (5VDC)	0.40A	
Weight	0.27kg	

○ : Compatible, △ : Partial change required, × : Incompatible

	Q68ADV	Q68ADI	Compatibil-ity	Precautions for replacement
	80μs/channel (When there is temperature drift compensation, the time calculated by adding 160μs will be used regardless of the number of channels used.)		○	The conversion speed of Q68ADV/I to A1S68AD has become quick. And then, on A1S68AD, the noise that did not import on A1S68AD can be imported as analog signal. In this case, use the averaging processing function to remove the effect of noise.
	±15V	±30mA	○	
	8 channels/module		○	
	Max. 100,000 times		○	
	Between the I/O terminal and programmable controller power supply: photocoupler isolation Between channels: not isolated		○	
	Between the I/O terminal and programmable controller power supply: 500VAC, for 1 minute		○	
	Between the I/O terminal and programmable controller power supply: 500VDC, 20MΩ or more		○	
	16 points (I/O assignment: intelligent 16 points)		△	The number of occupied I/O points has changed to 16 points.
	18-point terminal block		×	Wiring change is required.
	0.3 to 0.75mm ²		×	
	R1.25-3 (Solderless terminals with an insulation sleeve cannot be used.)		×	
	0.64A	0.64A	△	Recalculation of internal current consumption (5VDC) is required.
	0.19kg	0.19kg	△	

2.3.2 Functional comparison

○ : Available, - : Not available

Item	Description	A1S68AD	Q68ADV/I	Precautions for replacement
A/D conversion enable/disable	Specifies whether to enable or disable the A/D conversion for each channel. By disabling the conversion for the channels that are not used, the sampling time can be shortened.	○	○	
Sampling processing	The A/D conversion for analog input values is performed successively for each channel, and the digital output value is output upon each conversion.	○	○	The sampling processing time changes depending on the number of channels used (number of channels set to A/D conversion enable) and whether, with or without the temperature drift compensation function. (a) Without temperature drift compensation function (processing time) = (number of channels used) × 80 (μs/1 channel) (b) With temperature drift compensation function (processing time) = (number of channels used) × 80 (μs/1 channel) + 160μs
Averaging processing	For each channel, A/D conversion values are averaged for the set number of times or set amount of time, and the average value is output as a digital value.	○	○	The setting range of average time and count differ. Check the specifications, referring to the Analog-Digital Converter Module User's Manual.
Maximum and minimum values hold function	The maximum and minimum values of the digital output values are retained in the module.	-	○	
Temperature drift compensation function	Errors arising from changes in the ambient temperature of the module are automatically compensated for to improve conversion accuracy. The temperature drift compensation function can be performed at (A/D conversion time for all channels) + 160μs.	-	○	
Resolution mode	The resolution can be switched according to the application. The resolution mode setting is applicable to all channels.*1	-	○	
Online module change	A module can be replaced without the system being stopped.	-	○	The Process CPU and Redundant CPU support this function.

*1 For the A1S68AD, the resolution is 1/4000 (fixed).
For the Q68ADV/I, the resolution for both voltage and current is 1/4000 in normal resolution mode. In high resolution mode, the resolution for the voltage range -10 to 0 to 10V is 1/16000, and the resolution for the voltage in other ranges and current is 1/12000.

2.3.3 I/O signal comparison

Sequence program change is required as the I/O signals differ.

For details of the I/O signals or sequence program, refer to the Analog-Digital Converter Module User's Manual.

A1S68AD				Q68ADV/I				
Device No.	Signal name	Device No.	Signal name	Device No.	Signal name	Device No.	Signal name	
X0	WDT error flag	Y0	Use prohibited	X0	Module READY	Y0	Use prohibited	
X1	A-D conversion READY	Y1		X1	Temperature drift compensation flag	Y1		
X2	Error flag	Y2		Use prohibited	X2	Use prohibited		Y2
X3	Use prohibited	Y3			Y3			
X4		Y4			Y4			
X5		Y5			Y5			
X6		Y6			Y6			
X7		Y7			Y7			
X8		Use prohibited		Y8	X8	High resolution mode status flag		Y8
X9	Y9			X9	Operating condition setting completed flag	Y9		Operating condition setting request
XA	YA			XA	Offset/gain setting mode flag	YA		User range writing request
XB	YB			XB	Channel change completed flag	YB		Channel change request
XC	YC		XC	Use prohibited	YC	Use prohibited		
XD	YD		XD	Maximum value/minimum value reset completed flag	YD	Maximum value/minimum value reset request		
XE	Use prohibited		YE	XE	A/D conversion completed flag	YE	Use prohibited	
XF	Use prohibited		YF	XF	Error flag	YF	Error clear request	
X10			Y10	Use prohibited				
X11			Y11					
X12			Y12				Error reset	
X13			Y13					
X14		Y14						
X15		Y15						
X16		Y16						
X17		Y17						
X18		Y18						
X19		Y19						
X1A		Y1A						
X1B	Y1B							
X1C	Y1C							
X1D	Y1D							
X1E	Y1E							
X1F	Y1F							

2.3.4 Buffer memory address comparison

Sequence program change is required as the assignment of buffer memory differs.

For details of the buffer memory or sequence program, refer to the Analog-Digital Converter Module User's Manual.

A1S68AD			Q68ADV/I			
Address (decimal)	Name	Read/write	Address (decimal)	Name	Read/write	
0	A-D conversion enable/disable	R/W	0	A/D conversion enable/disable setting	R/W	
1	Writing data error code	R	1	CH1 Average time/average number of times		
2	Average processing specification	R/W	2	CH2 Average time/average number of times		
3	System area (Use prohibited)	-	3	CH3 Average time/average number of times		
to			to			
8			8	CH8 Average time/average number of times		
9			9	Averaging process setting		
10	CH1 Average time, count	R/W	10	A/D conversion completed flag		R
11	CH2 Average time, count		11	CH1 Digital output value		
to	to		to			
17	CH8 Average time, count	-	17	CH7 Digital output value		
18	System area (Use prohibited)		18	CH8 Digital output value		
19			19	Error code		
20	CH1 Digital output value	R	20	Setting range (CH1 to CH4)	R/W	
21	CH2 Digital output value		21	Setting range (CH5 to CH8)		
22	CH3 Digital output value		22	Offset/gain setting mode Offset specification		
23	CH4 Digital output value		23	Offset/gain setting mode Gain specification		
24	CH5 Digital output value		-	24	System area (Use prohibited)	
25	CH6 Digital output value			25		
26	CH7 Digital output value			26		
27	CH8 Digital output value			27		
28	A-D conversion completed flag	R/W	28		R	
29	System area (Use prohibited)	-	29			
			30	CH1 Maximum value		
			31	CH1 Minimum value		
			to	to		
			44	CH8 Maximum value		
			45	CH8 Minimum value		
			46	System area (Use prohibited)		
			to			
			157		-	
			158	Mode switching setting	R/W	
			159			
			160	System area (Use prohibited)	-	
			to			
			201			
			202	CH1 Industrial shipment settings offset value	R/W	
			203	CH1 Industrial shipment settings gain value		
			to	to		
			216	CH8 Industrial shipment settings offset value		
			217	CH8 Industrial shipment settings gain value		
			218	CH1 User range settings offset value		
			219	CH1 User range settings gain value		
			to	to		
			232	CH8 User range settings offset value		
			233	CH8 User range settings gain value		

2.4 A1S68AD (Replacing with the Q68AD-G)

2.4.1 Performance specifications comparison

Item		A1S68AD																								
Analog input	Voltage	-10 to 0 to +10VDC (Input resistance value: 1MΩ)																								
	Current	0 to +20mADC (Input resistance value: 250Ω)																								
Digital output		16-bit signed binary																								
I/O characteristics, maximum resolution		<p>I/O characteristics</p> <table border="1"> <thead> <tr> <th>Analog input</th> <th>Digital output</th> </tr> </thead> <tbody> <tr> <td>0 to +10V</td> <td>0 to +4000</td> </tr> <tr> <td>-10V to +10V</td> <td>-2000 to +2000</td> </tr> <tr> <td>0V to 5V or 0 to 20mA</td> <td>0 to +4000</td> </tr> <tr> <td>1 to 5V or 4 to 20mA</td> <td>0 to +4000</td> </tr> </tbody> </table> <p>Maximum resolution</p> <table border="1"> <thead> <tr> <th>Analog input</th> <th>Digital output</th> </tr> </thead> <tbody> <tr> <td>0 to +10V</td> <td>2.5mV</td> </tr> <tr> <td>-10V to +10V</td> <td>5mV</td> </tr> <tr> <td>0V to +5V</td> <td>1.25mV</td> </tr> <tr> <td>1 to 5V</td> <td>1mV</td> </tr> <tr> <td>0 to 20mA</td> <td>5μA</td> </tr> <tr> <td>4 to 20mA</td> <td>4μA</td> </tr> </tbody> </table>	Analog input	Digital output	0 to +10V	0 to +4000	-10V to +10V	-2000 to +2000	0V to 5V or 0 to 20mA	0 to +4000	1 to 5V or 4 to 20mA	0 to +4000	Analog input	Digital output	0 to +10V	2.5mV	-10V to +10V	5mV	0V to +5V	1.25mV	1 to 5V	1mV	0 to 20mA	5μA	4 to 20mA	4μA
Analog input	Digital output																									
0 to +10V	0 to +4000																									
-10V to +10V	-2000 to +2000																									
0V to 5V or 0 to 20mA	0 to +4000																									
1 to 5V or 4 to 20mA	0 to +4000																									
Analog input	Digital output																									
0 to +10V	2.5mV																									
-10V to +10V	5mV																									
0V to +5V	1.25mV																									
1 to 5V	1mV																									
0 to 20mA	5μA																									
4 to 20mA	4μA																									
Overall accuracy	Reference accuracy	Within ±1% at full scale (Digital output value: ±40)																								
	Temperature coefficient	-																								
Maximum conversion speed (sampling cycle)		0.5ms/channel (The speed is 1ms/channel on all channels if averaging processing is set even for one channel.)																								
Response time		-																								
Absolute maximum input		Voltage: ±35V current: ±30mA																								

○ : Compatible, △ : Partial change required, × : Incompatible

		Q68AD-G				Compatibil-ity	Precautions for replacement
		-10 to 10VDC (Input impedance: 1MΩ or more)				○	
		0 to 20mADC (Input resistance value: 250Ω)					
		16-bit signed binary (Normal resolution mode: -4096 to 4095, High resolution mode: -12288 to 12287, -16384 to 16383)				○	
	Input	Analog input range	Normal resolution mode		High resolution mode		△ If the resolution differs between AnS series and Q series modules, it needs to be matched using a sequence program or user range settings. (Refer to Appendix 4.)
Voltage		0 to 10V	0 to 4000	2.5mV	0 to 16000	0.625mV	
		0 to 5V		1.25mV	0 to 12000	0.416mV	
		1 to 5V		1.0mV		0.333mV	
		1 to 5V (Expanded mode)	-1000 to 4500	1.0mV	-3000 to 13500	0.333mV	
		-10 to 10V	-4000 to 4000	2.5mV	-16000 to 16000	0.625mV	
		Users range setting		0.375mV	-12000 to 12000	0.333mV	
Current		0 to 20mA	0 to 4000	5μA	0 to 12000	1.66μA	
		4 to 20mA		4μA		1.33μA	
		4 to 20mA (Expanded mode)	-1000 to 4500	4μA	-3000 to 13500	1.33μA	
		Users range setting	-4000 to 4000	1.37μA	-12000 to 12000	1.33μA	
		Reference accuracy: ±0.1% Normal resolution mode: ±4 digits High resolution mode (0 to 10V, -10 to 10V): ±16 digits High resolution mode (Other than the above ranges): ±12 digits				○	
		±71.4ppm/°C (0.00714%/°C)					
		10ms/channel				△	The conversion speed of Q68AD-G to A1S68AD has become slow. If fast conversion speed is required for control, the Q64AD is recommended.
		20ms					
		Voltage: ±15V current: ±30mA				○	

Item	A1S68AD	
Analog input points	8 channels/module	
Maximum number of writes for E ² PROM	-	
Isolation method	Between the input terminal and programmable controller power supply: photocoupler isolation Between channels: not isolated	
Dielectric withstand voltage	-	
Insulation resistance	-	
Number of occupied I/O points	32 points (I/O assignment: special 32 points)	
Connected terminal	20-point terminal block	
Applicable wire size	0.75 to 1.5mm ²	
Applicable solderless terminal	R1.25-3, 1.25-YS3, RAV1.25-3, V1.25-YS3A	
Internal current consumption (5VDC)	0.4A	
Weight	0.27kg	

○ : Compatible, △ : Partial change required, × : Incompatible

	Q68AD-G	Compatibil-ity	Precautions for replacement
	8 channels/module	○	
	Up to 50,000 times	○	
	Between the input terminal and programmable controller power supply: transformer isolation Between channels: transformer isolation	○	
	Between the input terminal and programmable controller power supply: 500VACrms, for 1 minute Between channels: 1000VACrms, for 1 minute	○	
	Between the input terminal and programmable controller power supply: 500VDC, 10MΩ or more Between channels: 500VDC, 10MΩ or more	○	
	16 points (I/O assignment: intelligent, 16 points)	△	The number of occupied I/O points has changed to 16 points.
	40-pin connector	×	Wiring change is required.
	Within 0.3mm ²	×	
	-	×	
	0.46A	△	Recalculation of internal current consumption (5VDC) is required.
	0.16kg	△	

2.4.2 Functional comparison

○ : Available, - : Not available

Item	Description	A1S68AD	Q68AD-G	Precautions for replacement
A/D conversion enable/disable	Specifies whether to enable or disable the A/D conversion for each channel. By disabling the conversion for the channels that are not used, the sampling time can be shortened.	○	○	
Sampling processing	The A/D conversion for analog input values is performed successively for each channel, and the digital output value is output upon each conversion.	○	○	
Averaging processing	For each channel, A/D conversion values are averaged for the set number of times or set amount of time, and the average value is output as a digital value.	○	○	The setting range of average time and count differ. Check the specifications, referring to the Analog-Digital Converter Module User's Manual.
	Moving average takes the average of the specified number of digital output values measured per sampling time.	-	○	
Maximum and minimum values hold function	The maximum and minimum values of the digital output values are retained in the module.	-	○	
Resolution mode	The resolution can be switched according to the application. The resolution mode is batch-set for all the channels.*1	-	○	
Input signal error detection function	The voltage/current outside the setting range is detected.	-	○	
Warning output function	(1) Process alarm A warning is output if a digital output value falls outside the setting range.	-	○	
	(2) Rate alarm A warning is output if the varying rate of a digital output value falls outside the preset varying rate range.			
Scaling function	Conversion of A/D conversion values to preset percentage values and loading into the buffer memory is available. Programming steps for the scaling can be eliminated.	-	○	
Online module change	A module can be replaced without the system being stopped.	-	○	The Process CPU and Redundant CPU support this function.

*1 For the A1S68AD, the resolution is 1/4000 (fixed).
For the Q68AD-G, the resolution for both voltage and current is 1/4000 in normal resolution mode. In high resolution mode, the resolution for the voltage range -10 to 0 to 10V is 1/16000, and the resolution for the voltage in other ranges and current is 1/12000.

2.4.3 I/O signal comparison

Sequence program change is required as the I/O signals differ.

For details of the I/O signals or sequence program, refer to the Channel Isolated Analog-Digital Converter Module, Channel Isolated Analog-Digital Converter Module (With Signal Conditioning Function) User's Manual.

A1S68AD				Q68AD-G			
Device No.	Signal name	Device No.	Signal name	Device No.	Signal name	Device No.	Signal name
X0	WDT error flag	Y0	Use prohibited	X0	Module ready	Y0	Use prohibited
X1	A-D conversion READY	Y1		X1	Use prohibited	Y1	
X2	Error flag	Y2		X2		Y2	
X3	Use prohibited	Y3		X3		Y3	
X4		Y4		X4		Y4	
X5		Y5		X5		Y5	
X6		Y6		X6	Y6		
X7		Y7		X7	High resolution mode status flag	Y7	
X8	Y8	X8		Warming output signal	Y8		
X9	Use prohibited	Y9		X9	Operating condition setting completed flag	Y9	Operating condition setting request
XA		YA		XA	Offset/gain setting mode flag	YA	User range writing request
XB		YB		XB	Channel change completed flag	YB	Channel change request
XC		YC	XC	Input signal error detection signal	YC	Use prohibited	
XD		YD	XD	Maximum value/minimum value reset completed flag	YD	Maximum value/minimum value reset request	
XE		YE	XE	A/D conversion completed flag	YE	Use prohibited	
XF		YF	XF	Error flag	YF	Error clear request	
X10		Y10					
X11		Y11					
X12		Y12					
X13	Y13						
X14	Y14						
X15	Y15						
X16	Y16						
X17	Y17						
X18	Y18						
X19	Y19	Use prohibited					
X1A	Y1A						
X1B	Y1B						
X1C	Y1C						
X1D	Y1D						
X1E	Y1E						
X1F	Y1F						

2.4.4 Buffer memory address comparison

Sequence program change is required as the assignment of buffer memory differs.

For details of the buffer memory or sequence program, refer to the Channel Isolated Analog-Digital Converter Module, Channel Isolated Analog-Digital Converter Module (With Signal Conditioning Function) User's Manual.

A1S68AD			Q68AD-G			
Address (decimal)	Name	Read/write	Address (decimal)	Name	Read/write	
0	A-D conversion enable/disable	R/W	0	A/D conversion enable/disable setting		
1	Writing data error code	R	1	CH1 Average time/Average number of times/ Moving average/Time constant settings	R/W	
2	Average processing specification	R/W	2	CH2 Average time/Average number of times/ Moving average/Time constant settings		
3	System area (Use prohibited)	-	3	CH3 Average time/Average number of times/ Moving average/Time constant settings		
to			to			
8			8	CH8 Average time/Average number of times/ Moving average/Time constant settings		
9			9	System area (Use prohibited)	-	
10	CH1 Average time, count	R/W	10	A/D conversion completed flag	R	
11	CH2 Average time, count		11	CH1 Digital output value		
to			to			
17	CH8 Average time, count		17	CH7 Digital output value		
18	System area (Use prohibited)	-	18	CH8 Digital output value	R	
19			19	Error code		
20	CH1 Digital output value	R	20	Setting range (CH1 to CH4)	R/W	
21	CH2 Digital output value		21	Setting range (CH5 to CH8)		
22	CH3 Digital output value		22	Offset/gain setting mode offset specification		
23	CH4 Digital output value		23	Offset/gain setting mode gain specification		
24	CH5 Digital output value		24	Averaging process specification (CH1 to CH4)		
25	CH6 Digital output value		25	Averaging process specification (CH5 to CH8)		
26	CH7 Digital output value		26	System area (Use prohibited)		-
27	CH8 Digital output value		27			
28	A-D conversion completed flag	R/W	28			
29	System area (Use prohibited)	-	29			
			30	CH1 Maximum value	R	
			31	CH1 Minimum value		
			to			
			44	CH8 Maximum value		
			45	CH8 Minimum value		
			46	System area (Use prohibited)	-	
			47	Input signal error detection extended/input signal error detection setting	R/W	
			48	Warning output setting	R	
			49	Input signal error detection flag		
			50	Warning output flag (Process alarm)		
			51	Warning output flag (Rate alarm)		
			52	System area (Use prohibited)	-	
			53	Scaling enable/disable setting	R/W	
			54	CH1 Scaling value	R	
			to			
			61	CH8 Scaling value		

Q68AD-G		
Address (decimal)	Name	Read/write
62	CH1 Scaling lower limit value	R/W
63	CH1 Scaling upper limit value	
to		
76	CH8 Scaling lower limit value	
77	CH8 Scaling upper limit value	-
78	System area (Use prohibited)	
to		
85		
86		CH1 Process alarm lower lower limit value
87	CH1 Process alarm lower upper limit value	
88	CH1 Process alarm upper lower limit value	
89	CH1 Process alarm upper upper limit value	
to		
114	CH8 Process alarm lower lower limit value	
115	CH8 Process alarm lower upper limit value	
116	CH8 Process alarm upper lower limit value	
117	CH8 Process alarm upper upper limit value	
118	CH1 Rate alarm warning detection period	
to		
125	CH8 Rate alarm warning detection period	
126	CH1 Rate alarm upper limit value	
127	CH1 Rate alarm lower limit value	
to		
140	CH8 Rate alarm upper limit value	
141	CH8 Rate alarm lower limit value	
142	CH1 Input signal error detection setting value/CH1 Input signal error detection lower limit setting value	
to		
149	CH8 Input signal error detection setting value/CH8 Input signal error detection lower limit setting value	
150	CH1 Input signal error detection upper limit setting value	
to		
157	CH8 Input signal error detection upper limit setting value	
158	Mode switching setting	-
159		
160		
to	System area (Use prohibited)	-
199		
200	Save data classification setting	R/W
201	System area (Use prohibited)	-
202	CH1 Factory default offset value	R/W
203	CH1 Factory default gain value	
to		
216	CH8 Factory default offset value	
217	CH8 Factory default gain value	
218	CH1 User range settings offset value	
219	CH1 User range settings gain value	
to		
232	CH8 User range settings offset value	
233	CH8 User range settings gain value	

3 ANALOG OUTPUT MODULE REPLACEMENT

3.1 List of Analog Output Module Alternative Models for Replacement

AnS/QnAS series		Transition to Q series	
Product	Model	Model	Remarks (Restrictions)
Analog output module	A1S62DA	Q62DAN	1) External wiring : Cable size is changed. 2) Number of slots : Not changed 3) Program : The number of occupied I/O points, I/O signals, and buffer memory addresses are changed. 4) Performance specifications: Changed. External power supply (24VDC) is required. 5) Functional specifications: Not changed
		Q64DAN	1) External wiring : Cable size is changed. 2) Number of slots : Not changed 3) Program : The number of occupied I/O points, I/O signals, and buffer memory addresses are changed. 4) Performance specifications: Changed. 4CH/module External power supply (24VDC) is required. 5) Functional specifications: Not changed
	A1S68DAI	Q68DAIN	1) External wiring : Cable size is changed. 2) Number of slots : Not changed 3) Program : The number of occupied I/O points, I/O signals, and buffer memory addresses are changed. 4) Performance specifications: Changed. External power supply (24VDC) is required. 5) Functional specifications: Not changed
	A1S68DAV	Q68DAVN	1) External wiring : Cable size is changed. 2) Number of slots: : Not changed 3) Program : The number of occupied I/O points, I/O signals, and buffer memory addresses are changed. 4) Performance specifications: Changed. External power supply (24VDC) is required. 5) Functional specifications: Not changed

☒ Point

(1) Conversion adaptor

The existing wiring for the AnS/QnAS series modules can be connected directly to the Q series modules using the upgrade tool (conversion adaptor) manufactured by Mitsubishi Electric Engineering Co., Ltd.

Product	MELSEC-AnS/QnAS series module	MELSEC-Q series module	Conversion adaptor
Analog output module	A1S62DA	Q62DAN	ERNT-ASQT62DA
	A1S68DAV	Q68DAVN	ERNT-ASQT68DA
	A1S68DAI	Q68DAIN	

For contact information for inquiries on the upgrade tool manufactured by Mitsubishi Electric Engineering Co., Ltd., refer to Section 2.1.

(2) Inrush Current

Q Series analog output unit is required 24VDC external power supply. Please select in consideration of the inrush current.

If an overcurrent occurs please consider the measures below.

- The rated current of the external power supply.
- The power supply line is relayed by the relay, and power-on one by one.

3.2 A1S62DA (Replacing with the Q62DAN)

3.2.1 Performance specifications comparison

Item	A1S62DA																																			
Digital input	Voltage: -4000 to 4000, -8000 to 8000, -12000 to 12000 Current: 0 to 4000, 0 to 8000, 0 to 12000																																			
Analog output	Voltage: -10 to 0 to +10VDC (External load resistance value: 2kΩ to 1MΩ) Current: 0 to 20mADC (External load resistance value: 0 to 600Ω)																																			
I/O characteristics	<table border="1"> <thead> <tr> <th rowspan="2"></th> <th colspan="3">Resolution</th> <th rowspan="2">Voltage output value*1</th> <th rowspan="2">Current output value*2</th> </tr> <tr> <th>1/4000</th> <th>1/8000</th> <th>1/12000</th> </tr> </thead> <tbody> <tr> <td rowspan="5">Digital input value</td> <td>4000</td> <td>8000</td> <td>12000</td> <td>10V</td> <td>20mA</td> </tr> <tr> <td>2000</td> <td>4000</td> <td>6000</td> <td>5V</td> <td>12mA</td> </tr> <tr> <td>0</td> <td>0</td> <td>0</td> <td>0</td> <td>4mA</td> </tr> <tr> <td>-2000</td> <td>-4000</td> <td>-6000</td> <td>-5V</td> <td></td> </tr> <tr> <td>-4000</td> <td>-8000</td> <td>-12000</td> <td>-10V</td> <td></td> </tr> </tbody> </table> <p>*1 The offset value is set to 0V and the gain value is set to 10V. *2 The offset value is set to 4mA and the gain value is set to 20mA.</p>		Resolution			Voltage output value*1	Current output value*2	1/4000	1/8000	1/12000	Digital input value	4000	8000	12000	10V	20mA	2000	4000	6000	5V	12mA	0	0	0	0	4mA	-2000	-4000	-6000	-5V		-4000	-8000	-12000	-10V	
	Resolution			Voltage output value*1	Current output value*2																															
	1/4000	1/8000	1/12000																																	
Digital input value	4000	8000	12000	10V	20mA																															
	2000	4000	6000	5V	12mA																															
	0	0	0	0	4mA																															
	-2000	-4000	-6000	-5V																																
	-4000	-8000	-12000	-10V																																
Maximum resolution	<table> <tbody> <tr> <td>1/4000</td> <td>2.5mV (10V)</td> <td>5μA (20mA)</td> </tr> <tr> <td>1/8000</td> <td>1.25mV (10V)</td> <td>2.5μA (20mA)</td> </tr> <tr> <td>1/12000</td> <td>0.83mV (10V)</td> <td>1.7μA (20mA)</td> </tr> </tbody> </table>	1/4000	2.5mV (10V)	5μA (20mA)	1/8000	1.25mV (10V)	2.5μA (20mA)	1/12000	0.83mV (10V)	1.7μA (20mA)																										
1/4000	2.5mV (10V)	5μA (20mA)																																		
1/8000	1.25mV (10V)	2.5μA (20mA)																																		
1/12000	0.83mV (10V)	1.7μA (20mA)																																		
Overall accuracy (accuracy at maximum analog output value)	±1% (voltage: ±100mV, current: ±200μA)																																			
Maximum conversion speed	Within 25ms/2 channels (same time for one channel)																																			
Absolute maximum output	Voltage: ±12V Current: +28mA																																			
Analog output points	2 channels/module																																			
Number of writes to E ² PROM	-																																			
Output short protection	Available																																			

○ : Compatible, △ : Partial change required, × : Incompatible

Q62DAN		Compatibility	Precautions for replacement																																										
16-bit signed binary Normal resolution mode: -4096 to 4095 High resolution mode: -12288 to 12287, -16384 to 16383		○	If the resolution differs between AnS series and Q series modules, it needs to be matched using a sequence program or user range settings. (Refer to Appendix 4.)																																										
Voltage: -10 to 10VDC (External load resistance value: 1kΩ to 1MΩ) Current: 0 to 20mADC (External load resistance value: 0 to 600Ω)		○																																											
<table border="1"> <thead> <tr> <th colspan="2" rowspan="2">Analog output range</th> <th colspan="2">Normal resolution mode</th> <th colspan="2">High resolution mode</th> </tr> <tr> <th>Digital input value</th> <th>Maximum resolution</th> <th>Digital input value</th> <th>Maximum resolution</th> </tr> </thead> <tbody> <tr> <td rowspan="4">Voltage</td> <td>0 to 5V</td> <td rowspan="2">0 to 4000</td> <td>1.25mV</td> <td rowspan="2">0 to 12000</td> <td>0.416mV</td> </tr> <tr> <td>1 to 5V</td> <td>1.0mV</td> <td>0.333mV</td> </tr> <tr> <td>-10 to 10V</td> <td rowspan="2">-4000 to 4000</td> <td>2.5mV</td> <td>-16000 to 16000</td> <td>0.625mV</td> </tr> <tr> <td>User range settings</td> <td>0.75mV</td> <td>-12000 to 12000</td> <td>0.333mV</td> </tr> <tr> <td rowspan="3">Current</td> <td>0 to 20mA</td> <td rowspan="2">0 to 4000</td> <td>5μA</td> <td rowspan="2">0 to 12000</td> <td>1.66μA</td> </tr> <tr> <td>4 to 20mA</td> <td>4μA</td> <td>1.33μA</td> </tr> <tr> <td>User range settings</td> <td>-4000 to 4000</td> <td>1.5μA</td> <td>-12000 to 12000</td> <td>0.83μA</td> </tr> </tbody> </table>		Analog output range		Normal resolution mode		High resolution mode		Digital input value	Maximum resolution	Digital input value	Maximum resolution	Voltage	0 to 5V	0 to 4000	1.25mV	0 to 12000	0.416mV	1 to 5V	1.0mV	0.333mV	-10 to 10V	-4000 to 4000	2.5mV	-16000 to 16000	0.625mV	User range settings	0.75mV	-12000 to 12000	0.333mV	Current	0 to 20mA	0 to 4000	5μA	0 to 12000	1.66μA	4 to 20mA	4μA	1.33μA	User range settings	-4000 to 4000	1.5μA	-12000 to 12000	0.83μA	△	If the resolution differs between AnS series and Q series modules, it needs to be matched using a sequence program or user range settings. (Refer to Appendix 4.)
Analog output range				Normal resolution mode		High resolution mode																																							
		Digital input value	Maximum resolution	Digital input value	Maximum resolution																																								
Voltage	0 to 5V	0 to 4000	1.25mV	0 to 12000	0.416mV																																								
	1 to 5V		1.0mV		0.333mV																																								
	-10 to 10V	-4000 to 4000	2.5mV	-16000 to 16000	0.625mV																																								
	User range settings		0.75mV	-12000 to 12000	0.333mV																																								
Current	0 to 20mA	0 to 4000	5μA	0 to 12000	1.66μA																																								
	4 to 20mA		4μA		1.33μA																																								
	User range settings	-4000 to 4000	1.5μA	-12000 to 12000	0.83μA																																								
Ambient temperature 25±5°C: within ±0.1% (voltage: ±10mV, current: ±20μA) Ambient temperature 0 to 55°C: within ±0.3% (voltage: ±30mV, current: ±60μA)		○																																											
80μs/channel		○																																											
Voltage: ±12V Current: 21mA		○																																											
2 channels/module		○																																											
Max. 100,000 times		○																																											
Available		○																																											

Item		A1S62DA	
Isolation method		Between the output terminal and programmable controller power supply: photocoupler isolation Between channels: not isolated	
Dielectric withstand voltage		-	
Insulation resistance		-	
Number of occupied I/O points		32 points (I/O assignment: special 32 points)	
Connected terminal		20-point terminal block	
Applicable wire size		0.75 to 1.5mm ²	
Applicable solderless terminal		1.25-3, 1.25-YS3A, V1.25-3, V1.25-YS3A	
Internal current consumption (5VDC)		0.80A	
External power supply	Voltage	-	
	Current consumption	-	
	Inrush current	-	
Weight		0.32kg	

○ : Compatible, △ : Partial change required, × : Incompatible

	Q62DAN	Compatibility	Precautions for replacement
	Between the I/O terminal and programmable controller power supply: photocoupler isolation Between output channels: not isolated Between external power supply and analog output: transformer isolation	○	
	Between the I/O terminal and programmable controller power supply: 500VAC, for 1 minute Between external power supply and analog output: 500VAC, for 1 minute	○	
	Between the I/O terminal and programmable controller power supply: 500VDC, 20MΩ or more Between external power supply and analog output: 500VDC, 20MΩ or more	○	
	16 points (I/O assignment: intelligent 16 points)	△	The number of occupied I/O points has changed to 16 points.
	18-point terminal block	×	Wiring change is required.
	0.3 to 0.75mm ²	×	
	R1.25-3 (Solderless terminals with an insulation sleeve cannot be used.)	×	
	0.33A	○	
	24VDC +20%, -15% Ripple, spike 500mV _{P-P} or less	×	External power supply (24VDC) is required.
	0.15A	×	
	2.5A, 250μs or less	×	
	0.19kg	△	

3.2.2 Functional comparison

○ : Available, - : Not available

Item	Description	A1S62DA	Q62DAN	Precautions for replacement
Analog output HOLD/CLEAR function	Determines the status of analog output values (hold or clear) when the programmable controller CPU stops or an error occurs.	○	○	
D/A conversion enable/disable function	Specifies whether to enable or disable the D/A conversion.	○	○	
D/A output enable/disable function	Specifies whether to output the D/A conversion value or the offset value.	○	○	
Synchronous output function	Obtains analog output synchronized with the programmable controller CPU.	-	○	
Analog output test while the programmable controller CPU is in the STOP status	Outputs the analog value converted from a digital value when CH□ Output enable/disable flag is forcibly turned on while the programmable controller CPU is in the STOP status.	-	○	
Resolution mode	The resolution can be switched according to the application.*1	○	○	
Online module replacement	A module can be replaced without the system being stopped.	-	○	The Process CPU and Redundant CPU support this function.

*1 For the A1S62AD, any mode (1/4000, 1/8000, or 1/12000) can be selected for both voltage and current input. For the Q62DAN, the mode is fixed at 1/4000 for both voltage and current input in normal resolution mode. In high resolution mode, the mode is fixed at 1/16000 when the input voltage range is -10 to 10V, and the mode is fixed at 1/12000 when the input voltage range is other than -10 to 10V or current is input.

3.2.3 I/O signal comparison

Sequence program change is required as the I/O signals differs.

For details of the I/O signals and sequence program, refer to the Digital-Analog Converter Module User's Manual.

A1S62DA				Q62DAN					
Device No.	Signal name	Device No.	Signal name	Device No.	Signal name	Device No.	Signal name		
X0	WDT error flag (A1S62DA detection)	Y0	Use prohibited	X0	Module ready	Y0	Use prohibited		
X1	D-A conversion READY	Y1		X1	Use prohibited	Y1	CH1 Output enable/disable flag		
X2	Error flag	Y2		X2		Y2	CH2 Output enable/disable flag		
X3	Use prohibited	Y3		X3		Use prohibited	Y3	Use prohibited	
X4		Y4		X4	Y4				
X5		Y5		X5	Y5				
X6		Y6		X6	Y6				
X7		Y7		X7	Y7				
X8		Y8		X8	High resolution mode status flag		Y8		
X9		Y9		X9	Operating condition setting completed flag		Y9		Operating condition setting request
XA		YA		XA	Offset/gain setting mode flag	YA	User range writing request		
XB		YB		XB	Channel change completed flag	YB	Channel change request		
XC		YC		XC	Set value change completed flag	YC	Set value change request		
XD	YD	XD		Synchronous output mode flag	YD	Synchronous output request			
XE	YE	XE		Use prohibited	YE	Use prohibited			
XF	Use prohibited	YF		XF	Error flag	YF	Error clear request		
X10	Use prohibited	Y10		CH1 D-A conversion output enable flag					
X11		Y11		CH2 D-A conversion output enable flag					
X12		Y12		Use prohibited					
X13		Y13							
X14		Y14							
X15		Y15							
X16		Y16							
X17		Y17							
X18		Y18	Error reset						
X19		Y19	Use prohibited						
X1A		Y1A							
X1B		Y1B							
X1C		Y1C							
X1D		Y1D							
X1E		Y1E							
X1F		Y1F							

3.2.4 Buffer memory address comparison

Sequence program change is required as the assignment of buffer memory differs.

For details of the buffer memories and sequence program, refer to the Digital-Analog Converter Module User's Manual.

A1S62DA			Q62DAN		
Address (decimal)	Name	Read/write	Address (decimal)	Name	Read/write
0	Analog output enable/disable channel	R/W	0	D/A conversion enable/disable	R/W
1	CH1 digital value		1	CH1 Digital value	
2	CH2 digital value		2	CH2 Digital value	
3	System area (Use prohibited)	-	3	System area (Use prohibited)	-
4					
5					
6					
7					
8	R/W	9	Resolution of digital value	9	R
10		CH1 set value check code	10	CH1 Set value check code	
11		CH2 set value check code	11	CH2 Set value check code	
12	System area (Use prohibited)	-	12	System area (Use prohibited)	-
13					
14					
15					
16					
17					
			18		
			19	Error code	R
			20	Setting range (CH1 and CH2)	
			21	System area (Use prohibited)	-
			22	Offset/gain setting mode Offset specification	R/W
			23	Offset/gain setting mode Gain specification	
			24	Offset/gain adjustment value specification	
			25	System area (Use prohibited)	-
			to		
			157		
			158	Mode switching setting	R/W
			159		
			160	System area (Use prohibited)	-
			to		
			199		
			200	Pass data classification setting	R/W
			201	System area (Use prohibited)	-
			202	CH1 Industrial shipment settings offset value	R/W
			203	CH1 Industrial shipment settings gain value	
			204	CH2 Industrial shipment settings offset value	
			205	CH2 Industrial shipment settings gain value	
			206	CH1 User range settings offset value	
			207	CH1 User range settings gain value	
			208	CH2 User range settings offset value	
			209	CH2 User range settings gain value	

3.3 A1S62DA (Replacing with the Q64DAN)

3.3.1 Performance specifications comparison

Item	A1S62DA																																		
Digital input	Voltage: -4000 to 4000, -8000 to 8000, -12000 to 12000 Current: 0 to 4000, 0 to 8000, 0 to 12000																																		
Analog output	Voltage: -10 to 0 to +10VDC (External load resistance value: 2kΩ to 1MΩ) Current: 0 to +20mADC (External load resistance value: 0 to 600Ω)																																		
I/O characteristics	<table border="1"> <thead> <tr> <th rowspan="2"></th> <th colspan="3">Resolution</th> <th rowspan="2">Voltage output value^{*1}</th> <th rowspan="2">Current output value^{*2}</th> </tr> <tr> <th>1/4000</th> <th>1/8000</th> <th>1/12000</th> </tr> </thead> <tbody> <tr> <td rowspan="5">Digital input value</td> <td>4000</td> <td>8000</td> <td>12000</td> <td>10V</td> <td>20mA</td> </tr> <tr> <td>2000</td> <td>4000</td> <td>6000</td> <td>5V</td> <td>12mA</td> </tr> <tr> <td>0</td> <td>0</td> <td>0</td> <td>0</td> <td>4mA</td> </tr> <tr> <td>-2000</td> <td>-4000</td> <td>-6000</td> <td>-5V</td> <td rowspan="2">-</td> </tr> <tr> <td>-4000</td> <td>-8000</td> <td>-12000</td> <td>-10V</td> </tr> </tbody> </table> <p>*1 The offset value is set to 0V and the gain value is set to 10V. *2 The offset value is set to 4mA and the gain value is set to 20mA.</p>		Resolution			Voltage output value ^{*1}	Current output value ^{*2}	1/4000	1/8000	1/12000	Digital input value	4000	8000	12000	10V	20mA	2000	4000	6000	5V	12mA	0	0	0	0	4mA	-2000	-4000	-6000	-5V	-	-4000	-8000	-12000	-10V
	Resolution			Voltage output value ^{*1}	Current output value ^{*2}																														
	1/4000	1/8000	1/12000																																
Digital input value	4000	8000	12000	10V	20mA																														
	2000	4000	6000	5V	12mA																														
	0	0	0	0	4mA																														
	-2000	-4000	-6000	-5V	-																														
	-4000	-8000	-12000	-10V																															
Maximum resolution	<table> <tbody> <tr> <td>1/4000</td> <td>2.5mV (10V)</td> <td>5μA (20mA)</td> </tr> <tr> <td>1/8000</td> <td>1.25mV (10V)</td> <td>2.5μA (20mA)</td> </tr> <tr> <td>1/12000</td> <td>0.83mV (10V)</td> <td>1.7μA (20mA)</td> </tr> </tbody> </table>	1/4000	2.5mV (10V)	5μA (20mA)	1/8000	1.25mV (10V)	2.5μA (20mA)	1/12000	0.83mV (10V)	1.7μA (20mA)																									
1/4000	2.5mV (10V)	5μA (20mA)																																	
1/8000	1.25mV (10V)	2.5μA (20mA)																																	
1/12000	0.83mV (10V)	1.7μA (20mA)																																	
Overall accuracy (accuracy at maximum analog output value)	±1% (voltage: ±100mV, current: ±200μA)																																		
Maximum conversion speed	Within 25ms/2 channels (same time for one channel)																																		
Absolute maximum output	Voltage: ±12V Current: +28mA																																		
Analog output points	2 channels/module																																		
Number of writes to E ² PROM	-																																		
Output short protection	Available																																		

○ : Compatible, △ : Partial change required, × : Incompatible

		Q64DAN				Compatibility	Precautions for replacement																																										
		16-bit signed binary (Normal resolution mode: -4096 to 4095, High resolution mode: -12288 to 12287, -16384 to 16383)				○	If the resolution differs between AnS series and Q series modules, it needs to be matched using a sequence program or user range settings. (Refer to Appendix 4.)																																										
		Voltage: -10 to 10VDC (External load resistance value: 1kΩ to 1MΩ) Current: 0 to 20mADC (External load resistance value: 0 to 600Ω)				○																																											
		<table border="1"> <thead> <tr> <th colspan="2" rowspan="2">Analog output range</th> <th colspan="2">Normal resolution mode</th> <th colspan="2">High resolution mode</th> </tr> <tr> <th>Digital input value</th> <th>Maximum resolution</th> <th>Digital input value</th> <th>Maximum resolution</th> </tr> </thead> <tbody> <tr> <td rowspan="4">Voltage</td> <td>0 to 5V</td> <td rowspan="2">0 to 4000</td> <td>1.25mV</td> <td rowspan="2">0 to 12000</td> <td>0.416mV</td> </tr> <tr> <td>1 to 5V</td> <td>1.0mV</td> <td>0.333mV</td> </tr> <tr> <td>-10 to 10V</td> <td rowspan="2">-4000 to 4000</td> <td>2.5mV</td> <td>-16000 to 16000</td> <td>0.625mV</td> </tr> <tr> <td>User range settings</td> <td>0.75mV</td> <td>-12000 to 12000</td> <td>0.333mV</td> </tr> <tr> <td rowspan="4">Current</td> <td>0 to 20mA</td> <td rowspan="2">0 to 4000</td> <td>5μA</td> <td rowspan="2">0 to 12000</td> <td>1.66μA</td> </tr> <tr> <td>4 to 20mA</td> <td>4μA</td> <td>1.33μA</td> </tr> <tr> <td rowspan="2">User range settings</td> <td rowspan="2">-4000 to 4000</td> <td rowspan="2">1.5μA</td> <td rowspan="2">-12000 to 12000</td> <td rowspan="2">0.83μA</td> </tr> </tbody> </table>				Analog output range		Normal resolution mode		High resolution mode		Digital input value	Maximum resolution	Digital input value	Maximum resolution	Voltage	0 to 5V	0 to 4000	1.25mV	0 to 12000	0.416mV	1 to 5V	1.0mV	0.333mV	-10 to 10V	-4000 to 4000	2.5mV	-16000 to 16000	0.625mV	User range settings	0.75mV	-12000 to 12000	0.333mV	Current	0 to 20mA	0 to 4000	5μA	0 to 12000	1.66μA	4 to 20mA	4μA	1.33μA	User range settings	-4000 to 4000	1.5μA	-12000 to 12000	0.83μA	△	If the resolution differs between AnS series and Q series modules, it needs to be matched using a sequence program or user range settings. (Refer to Appendix 4.)
Analog output range		Normal resolution mode		High resolution mode																																													
		Digital input value	Maximum resolution	Digital input value	Maximum resolution																																												
Voltage	0 to 5V	0 to 4000	1.25mV	0 to 12000	0.416mV																																												
	1 to 5V		1.0mV		0.333mV																																												
	-10 to 10V	-4000 to 4000	2.5mV	-16000 to 16000	0.625mV																																												
	User range settings		0.75mV	-12000 to 12000	0.333mV																																												
Current	0 to 20mA	0 to 4000	5μA	0 to 12000	1.66μA																																												
	4 to 20mA		4μA		1.33μA																																												
	User range settings	-4000 to 4000	1.5μA	-12000 to 12000	0.83μA																																												
								Ambient temperature 25±5°C: within ±0.1% (voltage: ±10mV, current: ±20μA) Ambient temperature 0 to 55°C: within ±0.3% (voltage: ±30mV, current: ±60μA)				○																																					
		80μs/channel				○																																											
		Voltage: ±12V Current: 21mA				○																																											
		4 channels/module				○																																											
		Max. 100,000 times				○																																											
		Available				○																																											

Item		A1S62DA	
Isolation method		Between the output terminal and programmable controller power supply: photocoupler isolation Between channels: not isolated	
Dielectric withstand voltage		-	
Insulation resistance		-	
Number of occupied I/O points		32 points (I/O assignment: special 32 points)	
Connected terminal		20-point terminal block	
Applicable wire size		0.75 to 1.5mm ²	
Applicable solderless terminal		1.25-3, 1.25-YS3A, V1.25-3, V1.25-YS3A	
Internal current consumption (5VDC)		0.8A	
External power supply	Voltage	-	
	Current consumption	-	
	Inrush current	-	
Weight		0.32kg	

○ : Compatible, △ : Partial change required, × : Incompatible

	Q64DAN	Compatibility	Precautions for replacement
	Between the I/O terminal and programmable controller power supply: photocoupler isolation Between output channels: not isolated Between external power supply and analog output: transformer isolation	○	
	Between the I/O terminal and programmable controller power supply: 500VAC, for 1 minute Between external power supply and analog output: 500VAC, for 1 minute	○	
	Between the I/O terminal and programmable controller power supply: 500VDC, 20MΩ or more Between external power supply and analog output: 500VDC, 20MΩ or more	○	
	16 points (I/O assignment: intelligent 16 points)	△	The number of occupied I/O points has changed to 16 points.
	18-point terminal block	×	Wiring change is required.
	0.3 to 0.75mm ²	×	
	R1.25-3 (Solderless terminals with an insulation sleeve cannot be used.)	×	
	0.34A	○	
	24VDC +20%, -15% Ripple, spike 500mV _{P-P} or less	×	External power supply (24VDC) is required.
	0.24A	×	
	2.5A, 260μs or less	×	
	0.20kg	△	

3.3.2 Functional comparison

○ : Available, - : Not available

Item	Description	A1S62DA	Q64DAN	Precautions for replacement
Analog output HOLD/CLEAR function	Determines the status of analog output values (hold or clear) when the programmable controller CPU stops or an error occurs.	○	○	
D/A conversion enable/disable function	Specifies whether to enable or disable the D/A conversion.	○	○	
D/A output enable/disable function	Specifies whether to output the D/A conversion value or the offset value.	○	○	
Synchronous output function	Obtains analog output synchronized with the programmable controller CPU.	-	○	
Analog output test while the programmable controller CPU is in the STOP status	Outputs the analog value converted from a digital value when CH□ Output enable/disable flag is forcibly turned on while the programmable controller CPU is in the STOP status.	○	○	
Resolution mode	The resolution can be switched according to the application.*1	○	○	
Online module replacement	A module can be replaced without the system being stopped.	-	○	The Process CPU and Redundant CPU support this function.

*1 For the A1S62AD, any mode (1/4000, 1/8000, or 1/12000) can be selected for both voltage and current input. For the Q64DAN, the mode is fixed at 1/4000 for both voltage and current input in normal resolution mode. In high resolution mode, the mode is fixed at 1/16000 when the input voltage range is -10 to 10V, and the mode is fixed at 1/12000 when the input voltage range is other than -10 to 10V or current is input.

3.3.3 I/O signal comparison

Sequence program change is required as the I/O signals differs.

For details of the I/O signals and sequence program, refer to the Digital-Analog Converter Module User's Manual.

A1S62DA				Q64DAN				
Device No.	Signal name	Device No.	Signal name	Device No.	Signal name	Device No.	Signal name	
X0	WDT error flag (A1S62DA detection)	Y0		X0	Module ready	Y0	Use prohibited	
X1	D/A conversion READY	Y1		X1		Y1	CH1 Output enable/disable flag	
X2	Error flag	Y2		X2		Y2	CH2 Output enable/disable flag	
X3		Y3		X3	Use prohibited	Y3	CH3 Output enable/disable flag	
X4		Y4		X4		Y4	CH4 Output enable/disable flag	
X5		Y5		X5		Y5		
X6		Y6		X6		Y6		
X7		Y7		X7		Y7	Use prohibited	
X8		Y8	Use prohibited	X8		High resolution mode status flag	Y8	
X9		Y9		X9		Operating condition setting completed flag	Y9	Operating condition setting request
XA		YA		XA	Offset/gain setting mode flag	YA	User range writing request	
XB		YB		XB	Channel change completed flag	YB	Channel change request	
XC		YC		XC	Set value change completed flag	YC	Set value change request	
XD		YD		XD	Synchronous output mode flag	YD	Synchronous output request	
XE	Use prohibited	YE		XE	Use prohibited	YE	Use prohibited	
XF		YF		XF	Error flag	YF	Error clear request	
X10		Y10	CH1 D-A conversion output enable flag					
X11		Y11	CH2 D-A conversion output enable flag					
X12		Y12						
X13		Y13						
X14		Y14	Use prohibited					
X15		Y15						
X16		Y16						
X17		Y17						
X18		Y18	Error reset					
X19		Y19						
X1A		Y1A						
X1B		Y1B						
X1C		Y1C	Use prohibited					
X1D		Y1D						
X1E		Y1E						
X1F		Y1F						

3.3.4 Buffer memory address comparison

Sequence program change is required as the assignment of buffer memory differs.

For details of the buffer memories and sequence program, refer to the Digital-Analog Converter Module User's Manual.

A1S62DA			Q64DAN			
Address (decimal)	Name	Read/write	Address (decimal)	Name	Read/write	
0	Analog output enable/disable channel	R/W	0	D/A conversion enable/disable	R/W	
1	CH1 digital value		1	CH1 Digital value		
2	CH2 digital value		2	CH2 Digital value		
3	System area (Use prohibited)	-	3	CH3 Digital value		
4			4	CH4 Digital value		
5			5	System area (Use prohibited)	-	
6			6			
7			7			
8	8					
9	Resolution of digital value	R/W	9	CH1 Set value check code	R	
10	CH1 set value check code		10			CH2 Set value check code
11	CH2 set value check code		11			CH3 Set value check code
12	System area (Use prohibited)	-	12			CH4 Set value check code
13			13	System area (Use prohibited)	-	
14			14			
15			15			
16			16			
17	17	17	17	System area (Use prohibited)	-	
			18			
			19	Error code	R	
			20	Setting range (CH1 to CH4)		
			21	System area (Prohibited)	-	
			22	Offset/gain setting mode Offset specification	R/W	
			23	Offset/gain setting mode Gain specification		
			24	Offset/gain adjustment value specification		
			25	System area (Use prohibited)	-	
			to			
			157			
			158	Mode switching setting	R/W	
			159			
			160	System area (Use prohibited)	-	
			to			
			199			
			200	Pass data classification setting	R/W	
			201	System area (Use prohibited)	-	
			202	CH1 Industrial shipment settings offset value	R/W	
			203	CH1 Industrial shipment settings gain value		
			to			
			208	CH4 Industrial shipment settings offset value		
			209	CH4 Industrial shipment settings gain value		
			210	CH1 User range settings offset value		
			211	CH1 User range settings gain value		
			to			
			216	CH4 User range settings offset value		
			217	CH4 User range settings gain value		

3.4 A1S68DAI

3.4.1 Performance specifications comparison

Item	A1S68DAI								
Digital input	16-bit signed binary Setting range: 0 to 4096								
Analog output	4 to 20mA DC (External load resistance value: 0 to 600Ω)								
I/O characteristics	<table border="1"> <thead> <tr> <th>Digital input value</th> <th>Analog output value</th> </tr> </thead> <tbody> <tr> <td>4000</td> <td>20mA</td> </tr> <tr> <td>2000</td> <td>12mA</td> </tr> <tr> <td>0</td> <td>4mA</td> </tr> </tbody> </table>	Digital input value	Analog output value	4000	20mA	2000	12mA	0	4mA
Digital input value	Analog output value								
4000	20mA								
2000	12mA								
0	4mA								
Maximum resolution of analog value	4μA								
Overall accuracy (accuracy at maximum analog output value)	±1.0% (±200μA)								
Conversion speed	Within 4ms/8 channels If the frequency of access from the programmable controller CPU using the FROM/TO instructions is high, the speed may be increased for about 6ms.								
Absolute maximum output	-								
Analog output points	8 channels/module								

○ : Compatible, △ : Partial change required, × : Incompatible

		Q68DAIN				Compatibility	Precautions for replacement																								
		16-bit signed binary (Normal resolution mode: -4096 to 4095, High resolution mode: -12288 to 12287)				○																									
		0 to 20mADC (External load resistance value: 0 to 600Ω)				○																									
		<table border="1"> <thead> <tr> <th colspan="2" rowspan="2">Analog output range</th> <th colspan="2">Normal resolution mode</th> <th colspan="2">High resolution mode</th> </tr> <tr> <th>Digital input value</th> <th>Maximum resolution</th> <th>Digital input value</th> <th>Maximum resolution</th> </tr> </thead> <tbody> <tr> <td rowspan="3">Current</td> <td>0 to 20mA</td> <td rowspan="2">0 to 4000</td> <td>5μA</td> <td rowspan="2">0 to 12000</td> <td>1.66μA</td> </tr> <tr> <td>4 to 20mA</td> <td>4μA</td> <td>1.33μA</td> </tr> <tr> <td>User range settings</td> <td>-4000 to 4000</td> <td>1.5μA</td> <td>-12000 to 12000</td> <td>0.83μA</td> </tr> </tbody> </table>				Analog output range		Normal resolution mode		High resolution mode		Digital input value	Maximum resolution	Digital input value	Maximum resolution	Current	0 to 20mA	0 to 4000	5μA	0 to 12000	1.66μA	4 to 20mA	4μA	1.33μA	User range settings	-4000 to 4000	1.5μA	-12000 to 12000	0.83μA	○	
Analog output range		Normal resolution mode		High resolution mode																											
		Digital input value	Maximum resolution	Digital input value	Maximum resolution																										
Current	0 to 20mA	0 to 4000	5μA	0 to 12000	1.66μA																										
	4 to 20mA		4μA		1.33μA																										
	User range settings	-4000 to 4000	1.5μA	-12000 to 12000	0.83μA																										
		Ambient temperature 25±5°C: within ±0.1% (±20μA) Ambient temperature 0 to 55°C: within ±0.3% (±60μA)				○																									
		80μs/channel				○																									
		21mA				○																									
		8 channels/module				○																									

Item		A1S68DAI	
Number of writes to E ² PROM		-	
Output short protection		Available	
Isolation method		Between the output terminal and programmable controller power supply: photocoupler isolation Between output channels: not isolated	
Dielectric withstand voltage		-	
Insulation resistance		-	
Number of occupied I/O points		32 points (I/O assignment: special 32 points)	
Connected terminal		20-point terminal block (M3.5 × 7 screws)	
Applicable wire size		0.75 to 1.5mm ²	
Applicable solderless terminal		R1.25-3, 1.25-YS3, RAV1.25-3, V1.25-YS3A	
Internal current consumption (5VDC)		0.85A	
External power supply	Voltage	-	
	Current consumption		
	Inrush current		
Weight		0.22kg	

○ : Compatible, △ : Partial change required, × : Incompatible

	Q68DAIN	Compatibility	Precautions for replacement
	Max. 100,000 times	○	
	Available	○	
	Between the I/O terminal and programmable controller power supply: photocoupler isolation Between output channels: no isolation Between external power supply and analog output: transformer isolation	○	
	Between the I/O terminal and programmable controller power supply: 500VAC, for 1 minute Between external power supply and analog output: 500VAC, for 1 minute	○	
	Between the I/O terminal and programmable controller power supply: 500VDC, 20MΩ or more Between external power supply and analog output: 500VDC, 20MΩ or more	○	
	16 points (I/O assignment: intelligent 16 points)	△	The number of occupied I/O points has changed to 16 points.
	18-point terminal block	×	Wiring change is required.
	0.3 to 0.75mm ²	×	
	FG terminal: R1.25-3, 1.25-YS3, RAV1.25-3, V1.25-YS3A Terminals other than FG: R1.25-3 (Solderless terminals with an insulation sleeve cannot be used.)	×	
	0.38A	○	
	24VDC +20%, -15% Ripple, spike 500mVp-p or less	×	External power supply (24VDC) is required.
	0.27A		
	2.5A, 230μs or less		
	0.20kg	△	

3.4.2 Functional comparison

○ : Available, - : Not available

Item	Description	A1S68 DAI	Q68 DAIN	Precautions for replacement																	
D/A conversion enable/disable function	Specifies whether to enable or disable the D/A conversion for each channel.	○	○	On Q68DAIN, by disabling the D/A conversion for the channels that are not used, the conversion speed can be shortened.																	
D/A output enable/disable function	Specifies whether to output the D/A conversion value or the offset value for each channel. The conversion speed stays constant regardless of whether D/A output is enabled or disabled.	○	○																		
Synchronous output function	Obtains analog output synchronized with the programmable controller CPU. The analog output will be updated after Synchronous output request (YD) is set to ON and the time specified as "programmable controller CPU processing time +120μs" has elapsed. However, the analog output will be fixed to CH1, and other channels (CH2 to CH8) cannot be used. When the module is mounted on a remote I/O station, the analog output will not be synchronized because of a link scan delay if the synchronous output function is specified.	-	○																		
Analog output HOLD/CLEAR function	Holds an analog value that was output when the programmable controller CPU is in the STOP status or an error occurs.	○	○	<ol style="list-style-type: none"> 1) On Q68DAIN, the setting of HOLD/CLEAR is carried out for each channel. 2) For the Q68DAIN, the status is set with the intelligent function module switch setting of GX Developer. 3) Check the execution status of output, referring to the "Analog output status combination list" in the Digital-Analog Converter Module User's Manual. 																	
Analog output test while the programmable controller CPU is in the STOP status	Outputs the analog value converted from a digital value when CH□ Output enable/disable flag is forcibly turned on while the programmable controller CPU is in the STOP status.	○	○																		
	<table border="1"> <thead> <tr> <th rowspan="2">Setting combination</th> <th>D/A conversion enable/disable</th> <th colspan="2">Enable</th> <th colspan="2">Disable</th> </tr> <tr> <th>CH□ Output enable/disable flag</th> <th>Enable</th> <th>Disable</th> <th>Enable</th> <th>Disable</th> </tr> </thead> <tbody> <tr> <td>Analog output test</td> <td>Allowed</td> <td>Not allowed</td> <td>Not allowed</td> <td>Not allowed</td> <td>Not allowed</td> </tr> </tbody> </table>	Setting combination	D/A conversion enable/disable	Enable		Disable		CH□ Output enable/disable flag	Enable	Disable	Enable	Disable	Analog output test	Allowed	Not allowed	Not allowed	Not allowed	Not allowed			
Setting combination	D/A conversion enable/disable		Enable		Disable																
	CH□ Output enable/disable flag	Enable	Disable	Enable	Disable																
Analog output test	Allowed	Not allowed	Not allowed	Not allowed	Not allowed																
Resolution mode	The resolution can be switched according to the application.*1 The resolution mode is batch-set for all channels.	-	○																		
Online module replacement	A module can be replaced without the system being stopped.	-	○	The Process CPU and Redundant CPU support this function.																	

*1 For the A1S68DAI, the mode is fixed at 1/4000.

For the Q68DAIN, the mode is fixed at 1/4000 in normal resolution mode. In high resolution mode, the mode is fixed at 1/12000.

3.4.3 I/O signal comparison

Sequence program change is required as the I/O signals differ.

For details of the I/O signals and sequence program, refer to the Digital-Analog Converter Module User's Manual.

A1S68DAI				Q68DAIN				
Device No.	Signal name	Device No.	Signal name	Device No.	Signal name	Device No.	Signal name	
X0	WDT error flag (A1S68DAI detection)	Y0		X0	Module ready	Y0	Use prohibited	
X1	D/A conversion READY	Y1		X1		Y1	CH1 Output enable/disable flag	
X2	Error flag	Y2		X2		Y2	CH2 Output enable/disable flag	
X3		Y3		X3		Y3	CH3 Output enable/disable flag	
X4		Y4		X4	Use prohibited	Y4	CH4 Output enable/disable flag	
X5		Y5		X5		Y5	CH5 Output enable/disable flag	
X6		Y6		X6		Y6	CH6 Output enable/disable flag	
X7		Y7	Use prohibited	X7		Y7	CH7 Output enable/disable flag	
X8		Y8		X8		High resolution mode status flag	Y8	CH8 Output enable/disable flag
X9		Y9		X9		Operating condition setting completed flag	Y9	Operating condition setting request
XA		YA		XA		Offset/gain setting mode flag	YA	User range writing request
XB		YB		XB		Channel change completed flag	YB	Channel change request
XC	Use prohibited	YC		XC	Set value change completed flag	YC	Set value change request	
XD		YD		XD	Synchronous output mode flag	YD	Synchronous output request	
XE		YE		XE	Use prohibited	YE	Use prohibited	
XF		YF		XF	Error flag	YF	Error clear request	
X10		Y10						
X11		Y11						
X12		Y12						
X13		Y13	D/A conversion value output enable flag					
X14		Y14						
X15		Y15						
X16		Y16						
X17		Y17						
X18		Y18	Error reset flag					
X19		Y19						
X1A		Y1A						
X1B		Y1B						
X1C		Y1C	Use prohibited					
X1D		Y1D						
X1E		Y1E						
X1F		Y1F						

3.4.4 Buffer memory address comparison

Sequence program change is required as the assignment of buffer memory differs.

For details of the buffer memories and sequence program, refer to the Digital-Analog Converter Module User's Manual.

A1S68DAI			Q68DAIN				
Address (decimal)	Name	Read/write	Address (decimal)	Name	Read/write		
0	Analog output enable/disable channel	R/W	0	D/A conversion enable/disable	R/W		
1	CH1 digital value		1	CH1 Digital value			
2	CH2 digital value		2	CH2 Digital value			
3	CH3 digital value		3	CH3 Digital value			
4	CH4 digital value		4	CH4 Digital value			
5	CH5 digital value		5	CH5 Digital value			
6	CH6 digital value		6	CH6 Digital value			
7	CH7 digital value		7	CH7 Digital value			
8	CH8 digital value	-	8	CH8 Digital value	-		
9	System area (Use prohibited)		9	System area (Use prohibited)			
10	CH1 set value check code		R	10		CH1 Set value check code	R
11	CH2 set value check code			11		CH2 Set value check code	
12	CH3 set value check code			12		CH3 Set value check code	
13	CH4 set value check code			13		CH4 Set value check code	
14	CH5 set value check code			14		CH5 Set value check code	
15	CH6 set value check code			15		CH6 Set value check code	
16	CH7 set value check code			16		CH7 Set value check code	
17	CH8 set value check code			17		CH8 Set value check code	
			18	CH8 Set value check code			
			19	Error code			
			20	Setting range (CH1 to CH4)			
			21	Setting range (CH5 to CH8)			
			22	Offset/gain setting mode Offset specification		R/W	
			23	Offset/gain setting mode Gain specification			
			24	Offset/gain adjustment value specification			
		25	System area (Use prohibited)	-			
		to					
		157					
		158	Mode switching setting	R/W			
		159					
		160	System area (Use prohibited)	-			
		to					
		201					
		202	CH1 Industrial shipment settings offset value	R/W			
		203	CH1 Industrial shipment settings gain value				
		204	CH2 Industrial shipment settings offset value				
		205	CH2 Industrial shipment settings gain value				
		206	CH3 Industrial shipment settings offset value				
		207	CH3 Industrial shipment settings gain value				
		208	CH4 Industrial shipment settings offset value				
		209	CH4 Industrial shipment settings gain value				
		210	CH5 Industrial shipment settings offset value				
		211	CH5 Industrial shipment settings gain value				
		212	CH6 Industrial shipment settings offset value				
		213	CH6 Industrial shipment settings gain value				
		214	CH7 Industrial shipment settings offset value				
		215	CH7 Industrial shipment settings gain value				
		216	CH8 Industrial shipment settings offset value				
		217	CH8 Industrial shipment settings gain value				

Q68DAIN		
Address (decimal)	Name	Read/write
218	CH1 User range settings offset value	R/W
219	CH1 User range settings gain value	
220	CH2 User range settings offset value	
221	CH2 User range settings gain value	
222	CH3 User range settings offset value	
223	CH3 User range settings gain value	
224	CH4 User range settings offset value	
225	CH4 User range settings gain value	
226	CH5 User range settings offset value	
227	CH5 User range settings gain value	
228	CH6 User range settings offset value	
229	CH6 User range settings gain value	
230	CH7 User range settings offset value	
231	CH7 User range settings gain value	
232	CH8 User range settings offset value	
233	CH8 User range settings gain value	

3.5 A1S68DAV

3.5.1 Performance specifications comparison

Item	A1S68DAV													
Digital input	16-bit signed binary Setting range: -2048 to 2047													
Analog output	-10 to 0 to 10VDC (External load resistance value: 2kΩ to 1MΩ)													
I/O characteristics	<table border="1"> <thead> <tr> <th>Digital input value</th> <th>Analog output value</th> </tr> </thead> <tbody> <tr> <td>2000</td> <td>10V</td> </tr> <tr> <td>1000</td> <td>5V</td> </tr> <tr> <td>0</td> <td>0V</td> </tr> <tr> <td>-1000</td> <td>-5V</td> </tr> <tr> <td>-2000</td> <td>-10V</td> </tr> </tbody> </table>	Digital input value	Analog output value	2000	10V	1000	5V	0	0V	-1000	-5V	-2000	-10V	
Digital input value	Analog output value													
2000	10V													
1000	5V													
0	0V													
-1000	-5V													
-2000	-10V													
Maximum resolution of analog value	5mV													
Overall accuracy (accuracy at maximum analog output value)	±1.0% (±100mV)													
Conversion speed	Within 4ms/8 channels If the frequency of access from the programmable controller CPU using the FROM/TO instructions is high, the speed may be increased for about 6ms.													
Absolute maximum output	-													
Analog output points	8 channels/module													
Number of writes to E ² PROM	-													
Output short protection	Available													
Isolation method	Between the output terminal and programmable controller power supply: photocoupler isolation Between output channels: not isolated													
Dielectric withstand voltage	-													
Insulation resistance	-													

○ : Compatible, △ : Partial change required, × : Incompatible

		Q68DAVN				Compatibility	Precautions for replacement																												
		16-bit signed binary (Normal resolution mode: -4096 to 4095, High resolution mode: -12288 to 12287, -16384 to 16383)				△	If the resolution differs between AnS series and Q series modules, it needs to be matched using a sequence program or user range settings. (Refer to Appendix 4.)																												
		-10 to 10VDC (External load resistance value: 1kΩ to 1MΩ)				○																													
		<table border="1"> <thead> <tr> <th colspan="2" rowspan="2">Analog output range</th> <th colspan="2">Normal resolution mode</th> <th colspan="2">High resolution mode</th> </tr> <tr> <th>Digital input value</th> <th>Maximum resolution</th> <th>Digital input value</th> <th>Maximum resolution</th> </tr> </thead> <tbody> <tr> <td rowspan="4">Voltage</td> <td>0 to 5V</td> <td rowspan="2">0 to 4000</td> <td>1.25mV</td> <td rowspan="2">0 to 12000</td> <td>0.416mV</td> </tr> <tr> <td>1 to 5V</td> <td>1.0mV</td> <td>0.333mV</td> </tr> <tr> <td>-10 to 10V</td> <td rowspan="2">-4000 to 4000</td> <td>2.5mV</td> <td>-16000 to 16000</td> <td>0.625mV</td> </tr> <tr> <td>User range settings</td> <td>0.75mV</td> <td>-12000 to 12000</td> <td>0.333mV</td> </tr> </tbody> </table>				Analog output range		Normal resolution mode		High resolution mode		Digital input value	Maximum resolution	Digital input value	Maximum resolution	Voltage	0 to 5V	0 to 4000	1.25mV	0 to 12000	0.416mV	1 to 5V	1.0mV	0.333mV	-10 to 10V	-4000 to 4000	2.5mV	-16000 to 16000	0.625mV	User range settings	0.75mV	-12000 to 12000	0.333mV	△	If the resolution differs between AnS series and Q series modules, it needs to be matched using a sequence program or user range settings. (Refer to Appendix 4.)
Analog output range		Normal resolution mode		High resolution mode																															
		Digital input value	Maximum resolution	Digital input value	Maximum resolution																														
Voltage	0 to 5V	0 to 4000	1.25mV	0 to 12000	0.416mV																														
	1 to 5V		1.0mV		0.333mV																														
	-10 to 10V	-4000 to 4000	2.5mV	-16000 to 16000	0.625mV																														
	User range settings		0.75mV	-12000 to 12000	0.333mV																														
		Ambient temperature 25±5°C: within ±0.1% (±10mV) Ambient temperature 0 to 55°C: within ±0.3% (±30mV)				○																													
		80μs/channel				○																													
		±12V				○																													
		8 channels/module				○																													
		Max. 100,000 times				○																													
		Available				○																													
		Between the I/O terminal and programmable controller power supply: photocoupler isolation Between output channels: not isolated Between external power supply and analog output: transformer isolation				○																													
		Between the I/O terminal and programmable controller power supply: 500VAC, for 1 minute Between external power supply and analog output: 500VAC, for 1 minute				○																													
		Between the I/O terminal and programmable controller power supply: 500VDC, 20MΩ or more Between external power supply and analog output: 500VDC, 20MΩ or more				○																													

Item		A1S68DAV	
Number of occupied I/O points		32 points (I/O assignment: special 32 points)	
Connected terminal		20-point terminal block (M3.5 × 7 screws)	
Applicable wire size		0.75 to 1.5mm ²	
Applicable solderless terminal		R1.25-3, 1.25-YS3, RAV1.25-3, V1.25-YS3A	
Internal current consumption (5VDC)		0.65A	
External power supply	Voltage	-	
	Current consumption	-	
	Inrush current	-	
Weight		0.22kg	

○ : Compatible, △ : Partial change required, × : Incompatible

	Q68DAVN	Compatibility	Precautions for replacement
	16 points (I/O assignment: intelligent 16 points)	△	The number of occupied I/O points has changed to 16 points.
	18-point terminal block	×	Wiring change is required.
	0.3 to 0.75mm ²	×	
	FG terminal: R1.25-3, 1.25-YS3, RAV1.25-3, V1.25-YS3A Terminals other than FG: R1.25-3 (Solderless terminals with an insulation sleeve cannot be used.)	×	
	0.38A	○	
	24VDC +20%, -15% Ripple, spike 500mVp-p or less	×	External power supply is required.
	0.20A		
	2.5A, 230μs or less		
	0.20kg	△	

3.5.2 Functional comparison

○ : Available, - : Not available

Item	Description	A1S68 DAV	Q68 DAVN	Precautions for replacement																	
D/A conversion enable/disable function	Specifies whether to enable or disable the D/A conversion for each channel.	○	○	On Q68DAVN, by disabling the D/A conversion for the channels that are not used, the conversion speed can be shortened.																	
D/A output enable/disable function	Specifies whether to output the D/A conversion value or the offset value for each channel. The conversion speed stays constant regardless of whether D/A output is enabled or disabled.	○	○																		
Synchronous output function	Obtains analog output synchronized with the programmable controller CPU. The analog output will be updated after Synchronous output request (YD) is set to ON and the time specified as "programmable controller CPU processing time + 120μs" has elapsed. However, the analog output will be fixed to CH1, and other channels (CH2 to CH8) cannot be used. When the module is mounted on a remote I/O station, the analog output will not be synchronized because of a link scan delay if the synchronous output function is specified.	-	○																		
Analog output HOLD/CLEAR function	Holds an analog value that was output when the programmable controller CPU is in the STOP status or an error occurs.	○	○	<ol style="list-style-type: none"> 1) On Q68DAVN, the setting of HOLD/CLEAR is carried out for each channel. 2) For the Q68DAVN, the status is set with the intelligent function module switch setting of GX Developer. 3) Check the execution status of output, referring to "Analog output status combination list" in the Digital-Analog Converter Module User's Manual. 																	
Analog output test while the programmable controller CPU is in the STOP status	Outputs the analog value converted from a digital value when CH□ Output enable/disable flag is forcibly turned on while the programmable controller CPU is in the STOP status.	○	○																		
	<table border="1"> <thead> <tr> <th rowspan="2">Setting combination</th> <th>D/A conversion enable/disable</th> <th colspan="2">Enable</th> <th colspan="2">Disable</th> </tr> <tr> <th>CH□ Output enable/disable flag</th> <th>Enable</th> <th>Disable</th> <th>Enable</th> <th>Disable</th> </tr> </thead> <tbody> <tr> <td>Analog output test</td> <td>Allowed</td> <td>Not allowed</td> <td>Not allowed</td> <td></td> <td></td> </tr> </tbody> </table>	Setting combination	D/A conversion enable/disable	Enable		Disable		CH□ Output enable/disable flag	Enable	Disable	Enable	Disable	Analog output test	Allowed	Not allowed	Not allowed					
Setting combination	D/A conversion enable/disable		Enable		Disable																
	CH□ Output enable/disable flag	Enable	Disable	Enable	Disable																
Analog output test	Allowed	Not allowed	Not allowed																		
Resolution mode	The resolution can be switched according to the application.*1 The resolution mode is batch-set for all channels.	-	○																		
Online module replacement	A module can be replaced without the system being stopped.	-	○	The Process CPU and Redundant CPU support this function.																	

*1 For the A1S68DAV, the mode is fixed at 1/4000 (-2000 to 2000).

For the Q68DAVN, the mode is fixed at 1/4000 in normal resolution mode. In high resolution mode, the mode is fixed at 1/16000 when the input voltage range is -10 to 10V, and the mode is fixed at 1/12000 when the input voltage range is other than -10 to 10V.

3.5.3 I/O signal comparison

Sequence program change is required as the I/O signals differ.

For details of the I/O signals and sequence program, refer to the Digital-Analog Converter Module User's Manual.

A1S68DAV				Q68DAVN				
Device No.	Signal name	Device No.	Signal name	Device No.	Signal name	Device No.	Signal name	
X0	WDT error flag (A1S68DAV detection)	Y0		X0	Module ready	Y0	Use prohibited	
X1	D/A conversion READY	Y1		X1		Y1	CH1 Output enable/disable flag	
X2	Error flag	Y2		X2		Y2	CH2 Output enable/disable flag	
X3		Y3		X3		Y3	CH3 Output enable/disable flag	
X4		Y4		X4	Use prohibited	Y4	CH4 Output enable/disable flag	
X5		Y5		X5		Y5	CH5 Output enable/disable flag	
X6		Y6		X6		Y6	CH6 Output enable/disable flag	
X7		Y7	Use prohibited	X7		Y7	CH7 Output enable/disable flag	
X8		Y8		X8		High resolution mode status flag	Y8	CH8 Output enable/disable flag
X9		Y9		X9		Operating condition setting completed flag	Y9	Operating condition setting request
XA		YA		XA		Offset/gain setting mode flag	YA	User range writing request
XB		YB		XB		Channel change completed flag	YB	Channel change request
XC		YC		XC	Set value change completed flag	YC	Set value change request	
XD	Use prohibited	YD		XD	Synchronous output mode flag	YD	Synchronous output request	
XE		YE		XE	Use prohibited	YE	Use prohibited	
XF		YF	XF	Error flag	YF	Error clear request		
X10		Y10						
X11		Y11						
X12		Y12						
X13		Y13	D/A conversion value output enable flag					
X14		Y14						
X15	Y15							
X16	Y16							
X17	Y17							
X18	Y18	Error reset flag						
X19	Y19							
X1A	Y1A							
X1B	Y1B							
X1C	Y1C	Use prohibited						
X1D	Y1D							
X1E	Y1E							
X1F	Y1F							

3.5.4 Buffer memory address comparison

Sequence program change is required as the assignment of buffer memory differs.

For details of the buffer memories and sequence program, refer to the Digital-Analog Converter Module User's Manual.

A1S68DAV			Q68DAVN		
Address (decimal)	Name	Read/write	Address (decimal)	Name	Read/write
0	Analog output enable/disable channel	R/W	0	D/A conversion enable/disable	R/W
1	CH1 digital value		1	CH1 Digital value	
2	CH2 digital value		2	CH2 Digital value	
3	CH3 digital value		3	CH3 Digital value	
4	CH4 digital value		4	CH4 Digital value	
5	CH5 digital value		5	CH5 Digital value	
6	CH6 digital value		6	CH6 Digital value	
7	CH7 digital value		7	CH7 Digital value	
8	CH8 digital value		8	CH8 Digital value	
9	System area (Use prohibited)	-	9	System area (Use prohibited)	-
10	CH1 set value check code	R	10	CH1 Set value check code	R
11	CH2 set value check code		11	CH2 Set value check code	
12	CH3 set value check code		12	CH3 Set value check code	
13	CH4 set value check code		13	CH4 Set value check code	
14	CH5 set value check code		14	CH5 Set value check code	
15	CH6 set value check code		15	CH6 Set value check code	
16	CH7 set value check code		16	CH7 Set value check code	
17	CH8 set value check code		17	CH8 Set value check code	
				18	
			19	Error code	
			20	Setting range (CH1 to CH4)	
			21	Setting range (CH5 to CH8)	
			22	Offset/gain setting mode Offset specification	R/W
			23	Offset/gain setting mode Gain specification	
			24	Offset/gain adjustment value specification	
			25	System area (Use prohibited)	-
			to		
			157		
			158	Mode switching setting	R/W
			159		
			160		
			to	System area (Use prohibited)	-
			201		
			202		
			203	CH1 Industrial shipment settings offset value	R/W
			204	CH1 Industrial shipment settings gain value	
			205	CH2 Industrial shipment settings offset value	
			206	CH2 Industrial shipment settings gain value	
			207	CH3 Industrial shipment settings offset value	
			208	CH3 Industrial shipment settings gain value	
			209	CH4 Industrial shipment settings offset value	
			210	CH4 Industrial shipment settings gain value	
			211	CH5 Industrial shipment settings offset value	
			212	CH5 Industrial shipment settings gain value	
			213	CH6 Industrial shipment settings offset value	
			214	CH6 Industrial shipment settings gain value	
			215	CH7 Industrial shipment settings offset value	
			216	CH7 Industrial shipment settings gain value	
			217	CH8 Industrial shipment settings offset value	
			218	CH8 Industrial shipment settings gain value	

Q68DAVN		
Address (decimal)	Name	Read/write
218	CH1 User range settings offset value	R/W
219	CH1 User range settings gain value	
220	CH2 User range settings offset value	
221	CH2 User range settings gain value	
222	CH3 User range settings offset value	
223	CH3 User range settings gain value	
224	CH4 User range settings offset value	
225	CH4 User range settings gain value	
226	CH5 User range settings offset value	
227	CH5 User range settings gain value	
228	CH6 User range settings offset value	
229	CH6 User range settings gain value	
230	CH7 User range settings offset value	
231	CH7 User range settings gain value	
232	CH8 User range settings offset value	
233	CH8 User range settings gain value	

4 ANALOG I/O MODULE REPLACEMENT

4.1 List of Analog I/O Module Alternative Models for Replacement

AnS/QnAS series		Transition to Q series	
Product	Model	Model	Remark (Restrictions)
Analog I/O module	A1S63ADA	Q64AD2DA	1) External wiring : Cable size is changed. 2) Number of slots : Not changed 3) Program : The number of occupied I/O points, I/O signals, and buffer memory addresses are changed. 4) Performance specifications: External power supply (24VDC) is required. 5) Functional specifications: Simple loop control (Function expressions) becomes unavailable.
	A1S66ADA	Q64AD2DA	1) External wiring : Cable size is changed. 2) Number of slots : Not changed 3) Program : The number of occupied I/O points, I/O signals, and buffer memory addresses are changed. 4) Performance specifications: Not changed 5) Functional specifications: Not changed

☒ Point

The existing wiring for the AnS/QnAS series modules can be connected directly to the Q series modules using the upgrade tool (conversion adaptor) manufactured by Mitsubishi Electric Engineering Co., Ltd.

Product	MELSEC-AnS/QnAS series module	MELSEC-Q series module	Conversion adaptor
Analog I/O module	A1S63ADA	Q64AD2DA	ERNT-ASQT63ADA

☒ Point

The Q64AD2DA of the replacement modules is not equipped with the simple loop control (Function expressions) function.

Continuous use of the simple loop control (Function expressions) which has been used with the A1S63ADA requires preparation of a sequence program.

- Processing of simple loop control (Function expressions) with the A1S63ADA

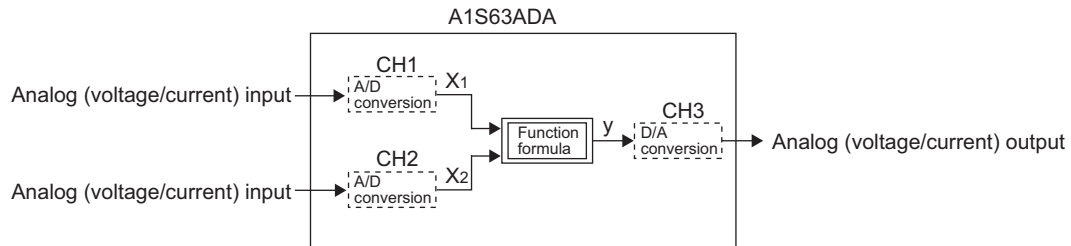

Examples of function formula

1) $y = AX_1 + BX_2 + C$

A, B, C: constant

X1: CH1 Analog input value

X2: CH2 Analog input value

y: CH3 Analog output value

2) $y = A \frac{X_1}{X_2} + C$

3) Coordinate specification: CH1 Analog input/CH3 Analog output

- Processing with the Q64AD2DA after the replacement

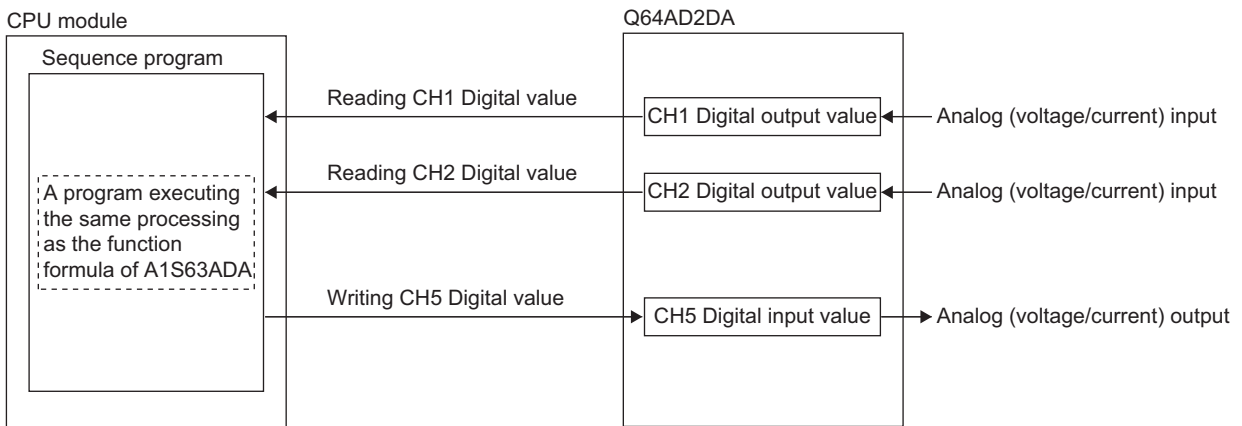

4.2 A1S63ADA

4.2.1 Performance specifications comparison

○ : Compatible, △ : Partial change required, × : Incompatible

Item	A1S63ADA	Q64AD2DA	Compatibility	Precautions for replacement																																																																																						
Number of analog input points	2 channels/module	4 channels/module	○																																																																																							
Analog input	Voltage	-10 to 0 to 10VDC (Input resistance value: 1MΩ)	○																																																																																							
	Current	-20 to 0 to 20mADC (Input resistance value: 250Ω)	△																																																																																							
Digital output	16 bit signed binary When 1/4000 is set: -4096 to 4095 When 1/8000 is set: -8192 to 8191 When 1/12000 is set: -12288 to 12287	Normal resolution mode: -96 to 4095, -4096 to 4095, -1096 to 4595 High resolution mode: -384 to 16383, -288 to 12287, -16384 to 16383, -3288 to 13787	△																																																																																							
I/O characteristics	<table border="1"> <thead> <tr> <th rowspan="2"></th> <th rowspan="2">Analog input</th> <th colspan="3">Digital output value (with gain 5V/20mA and offset 0V/4mA)</th> </tr> <tr> <th>1/4000</th> <th>1/8000</th> <th>1/12000</th> </tr> </thead> <tbody> <tr> <td rowspan="5">I/O characteristics</td> <td>10V</td> <td>4000</td> <td>8000</td> <td>12000</td> </tr> <tr> <td>5V 20mA</td> <td>2000</td> <td>4000</td> <td>6000</td> </tr> <tr> <td>0V 4mA</td> <td>0</td> <td>0</td> <td>0</td> </tr> <tr> <td>-5V -12mA</td> <td>-2000</td> <td>-4000</td> <td>-6000</td> </tr> <tr> <td>-10V</td> <td>-4000</td> <td>-8000</td> <td>-12000</td> </tr> <tr> <td rowspan="2">Resolution</td> <td>Voltage input</td> <td>2.5mV</td> <td>1.25mV</td> <td>0.83mV</td> </tr> <tr> <td>Current input</td> <td>10μA</td> <td>5μA</td> <td>3.33μA</td> </tr> </tbody> </table>		Analog input	Digital output value (with gain 5V/20mA and offset 0V/4mA)			1/4000	1/8000	1/12000	I/O characteristics	10V	4000	8000	12000	5V 20mA	2000	4000	6000	0V 4mA	0	0	0	-5V -12mA	-2000	-4000	-6000	-10V	-4000	-8000	-12000	Resolution	Voltage input	2.5mV	1.25mV	0.83mV	Current input	10μA	5μA	3.33μA	<table border="1"> <thead> <tr> <th rowspan="2"></th> <th rowspan="2">Analog input range</th> <th colspan="2">Normal resolution mode</th> <th colspan="2">High resolution mode</th> </tr> <tr> <th>Digital output value</th> <th>Maximum resolution</th> <th>Digital output value</th> <th>Maximum resolution</th> </tr> </thead> <tbody> <tr> <td rowspan="6">Voltage</td> <td>0 to 10V</td> <td rowspan="2">0 to 4000</td> <td>2.5mV</td> <td>0 to 16000</td> <td>0.625mV</td> </tr> <tr> <td>0 to 5V</td> <td>1.25mV</td> <td>0 to 12000</td> <td>0.416mV</td> </tr> <tr> <td>1 to 5V</td> <td>1.0mV</td> <td>12000</td> <td>0.333mV</td> </tr> <tr> <td>-10 to 10V</td> <td>-4000 to 4000</td> <td>2.5mV</td> <td>-16000 to 16000</td> <td>0.625mV</td> </tr> <tr> <td>1 to 5V (extended mode)</td> <td>-1000 to 4500</td> <td>1.0mV</td> <td>-3000 to 13500</td> <td>0.333mV</td> </tr> <tr> <td rowspan="3">Current</td> <td>0 to 20mA</td> <td>0 to 4000</td> <td>5μA</td> <td>0 to 12000</td> <td>1.66μA</td> </tr> <tr> <td>4 to 20mA</td> <td rowspan="2">-1000 to 4500</td> <td>4μA</td> <td rowspan="2">-3000 to 13500</td> <td>1.33μA</td> </tr> <tr> <td>4 to 20mA (extended mode)</td> <td>4μA</td> <td>1.33μA</td> </tr> </tbody> </table>		Analog input range	Normal resolution mode		High resolution mode		Digital output value	Maximum resolution	Digital output value	Maximum resolution	Voltage	0 to 10V	0 to 4000	2.5mV	0 to 16000	0.625mV	0 to 5V	1.25mV	0 to 12000	0.416mV	1 to 5V	1.0mV	12000	0.333mV	-10 to 10V	-4000 to 4000	2.5mV	-16000 to 16000	0.625mV	1 to 5V (extended mode)	-1000 to 4500	1.0mV	-3000 to 13500	0.333mV	Current	0 to 20mA	0 to 4000	5μA	0 to 12000	1.66μA	4 to 20mA	-1000 to 4500	4μA	-3000 to 13500	1.33μA	4 to 20mA (extended mode)	4μA	1.33μA	△	A resolution other than 1/4000 of the AnS series and Q series requires the support of a sequence program or the scaling function.
				Analog input	Digital output value (with gain 5V/20mA and offset 0V/4mA)																																																																																					
1/4000		1/8000	1/12000																																																																																							
I/O characteristics	10V	4000	8000	12000																																																																																						
	5V 20mA	2000	4000	6000																																																																																						
	0V 4mA	0	0	0																																																																																						
	-5V -12mA	-2000	-4000	-6000																																																																																						
	-10V	-4000	-8000	-12000																																																																																						
Resolution	Voltage input	2.5mV	1.25mV	0.83mV																																																																																						
	Current input	10μA	5μA	3.33μA																																																																																						
	Analog input range	Normal resolution mode		High resolution mode																																																																																						
		Digital output value	Maximum resolution	Digital output value	Maximum resolution																																																																																					
Voltage	0 to 10V	0 to 4000	2.5mV	0 to 16000	0.625mV																																																																																					
	0 to 5V		1.25mV	0 to 12000	0.416mV																																																																																					
	1 to 5V	1.0mV	12000	0.333mV																																																																																						
	-10 to 10V	-4000 to 4000	2.5mV	-16000 to 16000	0.625mV																																																																																					
	1 to 5V (extended mode)	-1000 to 4500	1.0mV	-3000 to 13500	0.333mV																																																																																					
	Current	0 to 20mA	0 to 4000	5μA	0 to 12000	1.66μA																																																																																				
4 to 20mA		-1000 to 4500	4μA	-3000 to 13500	1.33μA																																																																																					
4 to 20mA (extended mode)			4μA		1.33μA																																																																																					
Resolution			○																																																																																							
Overall accuracy (accuracy at maximum analog output value)	±1% When 1/4000 is set: ±40 When 1/8000 is set: ±80 When 1/12000 is set: ±120	<table border="1"> <thead> <tr> <th rowspan="2"></th> <th rowspan="2">Analog input range</th> <th colspan="2">Normal resolution mode</th> <th colspan="2">High resolution mode</th> </tr> <tr> <th>Ambient temperature</th> <th>0 to 55°C</th> <th>25±5°C</th> <th>0 to 55°C</th> <th>25±5°C</th> </tr> </thead> <tbody> <tr> <td rowspan="4">Voltage</td> <td>0 to 10V</td> <td rowspan="4">±0.4%</td> <td rowspan="4">±0.1% (±16 digits)</td> <td rowspan="4">±0.4%</td> <td rowspan="4">±0.1% (±16 digits)</td> </tr> <tr> <td>-10 to 10V</td> </tr> <tr> <td>0 to 5V</td> </tr> <tr> <td>1 to 5V (extended mode)</td> </tr> <tr> <td rowspan="3">Current</td> <td>0 to 20mA</td> <td rowspan="3">±0.4%</td> <td rowspan="3">±0.1% (±4 digits)</td> <td rowspan="3">±0.4%</td> <td rowspan="3">±0.1% (±12 digits)</td> </tr> <tr> <td>4 to 20mA</td> </tr> <tr> <td>4 to 20mA (extended mode)</td> </tr> </tbody> </table>		Analog input range	Normal resolution mode		High resolution mode		Ambient temperature	0 to 55°C	25±5°C	0 to 55°C	25±5°C	Voltage	0 to 10V	±0.4%	±0.1% (±16 digits)	±0.4%	±0.1% (±16 digits)	-10 to 10V	0 to 5V	1 to 5V (extended mode)	Current	0 to 20mA	±0.4%	±0.1% (±4 digits)	±0.4%	±0.1% (±12 digits)	4 to 20mA	4 to 20mA (extended mode)	○																																																											
	Analog input range	Normal resolution mode			High resolution mode																																																																																					
		Ambient temperature	0 to 55°C	25±5°C	0 to 55°C	25±5°C																																																																																				
Voltage	0 to 10V	±0.4%	±0.1% (±16 digits)	±0.4%	±0.1% (±16 digits)																																																																																					
	-10 to 10V																																																																																									
	0 to 5V																																																																																									
	1 to 5V (extended mode)																																																																																									
Current	0 to 20mA	±0.4%	±0.1% (±4 digits)	±0.4%	±0.1% (±12 digits)																																																																																					
	4 to 20mA																																																																																									
	4 to 20mA (extended mode)																																																																																									
Maximum conversion speed	When 1/4000 is set: 1ms/channel When 1/8000 is set: 2ms/channel When 1/12000 is set: 3ms/channel	500μs/channel	○																																																																																							
Absolute maximum input	Voltage ±15V Current ±28mA	Voltage ±15V Current 30mA	○																																																																																							

○ : Compatible, △ : Partial change required, × : Incompatible

Item		A1S63ADA	Q64AD2DA	Compat- ibility	Precautions for replacement																																																																																						
Number of analog output points		1 channel/module	2 channels/module	○																																																																																							
Digital input		When 1/4000 is set Voltage: -4000 to 4000 Current: 0 to 4000 When 1/8000 is set Voltage: -8000 to 8000 Current: 0 to 8000 When 1/12000 is set Voltage: -12000 to 12000 Current: 0 to 12000	Normal resolution mode: -96 to 4095, -4096 to 4095, -1096 to 4595 High resolution mode: -384 to 16383, -288 to 12287, -16384 to 16383, -3288 to 13787	○																																																																																							
Analog output	Voltage	-10 to 0 to 10VDC (External load resistance value: 2kΩ to 1MΩ)	-10 to 10VDC (External load resistance value: 1kΩ to 1MΩ)	○																																																																																							
	Current	0 to 20mADC (External load resistance value: 0 to 600Ω)	0 to 20mADC (External load resistance value: 0 to 600Ω)																																																																																								
I/O characteristics		<table border="1"> <thead> <tr> <th colspan="3">Digital input value</th> <th colspan="2">Analog output</th> </tr> <tr> <th>1/4000</th> <th>1/8000</th> <th>1/12000</th> <th>Voltage output value^{*1}</th> <th>Current output value^{*2}</th> </tr> </thead> <tbody> <tr> <td>4000</td> <td>8000</td> <td>12000</td> <td>10V</td> <td>20mA</td> </tr> <tr> <td>2000</td> <td>4000</td> <td>6000</td> <td>5V</td> <td>12mA</td> </tr> <tr> <td>0</td> <td>0</td> <td>0</td> <td>0</td> <td>4mA</td> </tr> <tr> <td>-2000</td> <td>-4000</td> <td>-6000</td> <td>-5V</td> <td>-</td> </tr> <tr> <td>-4000</td> <td>-8000</td> <td>-12000</td> <td>-10V</td> <td>-</td> </tr> </tbody> </table> <p>*1 Voltage output with the offset 0V and gain 10V (factory default) *2 Current output with the offset 4mA and gain 20mA (factory default)</p>	Digital input value			Analog output		1/4000	1/8000	1/12000	Voltage output value ^{*1}	Current output value ^{*2}	4000	8000	12000	10V	20mA	2000	4000	6000	5V	12mA	0	0	0	0	4mA	-2000	-4000	-6000	-5V	-	-4000	-8000	-12000	-10V	-	<table border="1"> <thead> <tr> <th rowspan="2">Input</th> <th rowspan="2">Analog input range</th> <th colspan="2">Normal resolution mode</th> <th colspan="2">High resolution mode</th> </tr> <tr> <th>Digital output value</th> <th>Maximum resolution</th> <th>Digital output value</th> <th>Maximum resolution</th> </tr> </thead> <tbody> <tr> <td rowspan="3">Voltage</td> <td>0 to 10V</td> <td rowspan="3">0 to 4000</td> <td>2.5mV</td> <td>0 to 16000</td> <td>0.625mV</td> </tr> <tr> <td>0 to 5V</td> <td>1.25mV</td> <td>0 to 12000</td> <td>0.416mV</td> </tr> <tr> <td>1 to 5V</td> <td>1.0mV</td> <td>12000</td> <td>0.333mV</td> </tr> <tr> <td rowspan="3">Voltage</td> <td>-10 to 10V</td> <td>-4000 to 4000</td> <td>2.5mV</td> <td>-16000 to 16000</td> <td>0.625mV</td> </tr> <tr> <td>1 to 5V (extended mode)</td> <td>-1000 to 4500</td> <td>1.0mV</td> <td>-3000 to 13500</td> <td>0.333mV</td> </tr> <tr> <td>0 to 20mA</td> <td>0 to 4000</td> <td>5μA</td> <td>0 to 12000</td> <td>1.66μA</td> </tr> <tr> <td rowspan="3">Current</td> <td>4 to 20mA</td> <td>4000</td> <td>4μA</td> <td>12000</td> <td>1.33μA</td> </tr> <tr> <td>4 to 20mA (extended mode)</td> <td>-1000 to 4500</td> <td>4μA</td> <td>-3000 to 13500</td> <td>1.33μA</td> </tr> </tbody> </table>	Input	Analog input range	Normal resolution mode		High resolution mode		Digital output value	Maximum resolution	Digital output value	Maximum resolution	Voltage	0 to 10V	0 to 4000	2.5mV	0 to 16000	0.625mV	0 to 5V	1.25mV	0 to 12000	0.416mV	1 to 5V	1.0mV	12000	0.333mV	Voltage	-10 to 10V	-4000 to 4000	2.5mV	-16000 to 16000	0.625mV	1 to 5V (extended mode)	-1000 to 4500	1.0mV	-3000 to 13500	0.333mV	0 to 20mA	0 to 4000	5μA	0 to 12000	1.66μA	Current	4 to 20mA	4000	4μA	12000	1.33μA	4 to 20mA (extended mode)	-1000 to 4500	4μA	-3000 to 13500	1.33μA	△	A resolution other than 1/4000 of the AnS series and Q series requires the support of a sequence program or the scaling function.
Digital input value			Analog output																																																																																								
1/4000	1/8000	1/12000	Voltage output value ^{*1}	Current output value ^{*2}																																																																																							
4000	8000	12000	10V	20mA																																																																																							
2000	4000	6000	5V	12mA																																																																																							
0	0	0	0	4mA																																																																																							
-2000	-4000	-6000	-5V	-																																																																																							
-4000	-8000	-12000	-10V	-																																																																																							
Input	Analog input range	Normal resolution mode		High resolution mode																																																																																							
		Digital output value	Maximum resolution	Digital output value	Maximum resolution																																																																																						
Voltage	0 to 10V	0 to 4000	2.5mV	0 to 16000	0.625mV																																																																																						
	0 to 5V		1.25mV	0 to 12000	0.416mV																																																																																						
	1 to 5V		1.0mV	12000	0.333mV																																																																																						
Voltage	-10 to 10V	-4000 to 4000	2.5mV	-16000 to 16000	0.625mV																																																																																						
	1 to 5V (extended mode)	-1000 to 4500	1.0mV	-3000 to 13500	0.333mV																																																																																						
	0 to 20mA	0 to 4000	5μA	0 to 12000	1.66μA																																																																																						
Current	4 to 20mA	4000	4μA	12000	1.33μA																																																																																						
	4 to 20mA (extended mode)	-1000 to 4500	4μA	-3000 to 13500	1.33μA																																																																																						
	Maximum resolution		<table border="1"> <tbody> <tr> <td>1/4000</td> <td>2.5mV (10V)</td> <td>5μA (20mA)</td> </tr> <tr> <td>1/8000</td> <td>1.25mV (10V)</td> <td>2.5μA (20mA)</td> </tr> <tr> <td>1/12000</td> <td>0.83mV (10V)</td> <td>1.7μA (20mA)</td> </tr> </tbody> </table>	1/4000	2.5mV (10V)	5μA (20mA)	1/8000	1.25mV (10V)	2.5μA (20mA)	1/12000	0.83mV (10V)	1.7μA (20mA)	<table border="1"> <tbody> <tr> <td>0 to 20mA</td> <td>0 to 4000</td> <td>5μA</td> <td>0 to 12000</td> <td>1.66μA</td> </tr> <tr> <td>4 to 20mA</td> <td>4000</td> <td>4μA</td> <td>12000</td> <td>1.33μA</td> </tr> <tr> <td>4 to 20mA (extended mode)</td> <td>-1000 to 4500</td> <td>4μA</td> <td>-3000 to 13500</td> <td>1.33μA</td> </tr> </tbody> </table>	0 to 20mA	0 to 4000	5μA	0 to 12000	1.66μA	4 to 20mA	4000	4μA	12000	1.33μA	4 to 20mA (extended mode)	-1000 to 4500	4μA	-3000 to 13500	1.33μA	○																																																														
1/4000	2.5mV (10V)	5μA (20mA)																																																																																									
1/8000	1.25mV (10V)	2.5μA (20mA)																																																																																									
1/12000	0.83mV (10V)	1.7μA (20mA)																																																																																									
0 to 20mA	0 to 4000	5μA	0 to 12000	1.66μA																																																																																							
4 to 20mA	4000	4μA	12000	1.33μA																																																																																							
4 to 20mA (extended mode)	-1000 to 4500	4μA	-3000 to 13500	1.33μA																																																																																							
Overall accuracy (accuracy at maximum analog output value)		±1% (Voltage: ±100mV, Current: ±200μA)	<table border="1"> <thead> <tr> <th rowspan="2">Analog input range</th> <th colspan="2">Normal resolution mode</th> <th colspan="2">High resolution mode</th> </tr> <tr> <th>Ambient temperature</th> <th>0 to 55°C</th> <th>25±5°C</th> <th>0 to 55°C</th> <th>25±5°C</th> </tr> </thead> <tbody> <tr> <td rowspan="4">Voltage</td> <td>0 to 10V</td> <td rowspan="4">±0.4% (±16 digits)</td> <td rowspan="4">±0.1% (±4 digits)</td> <td>±0.4% (±64 digits)</td> <td>±0.1% (±16 digits)</td> </tr> <tr> <td>-10 to 10V</td> <td rowspan="2">±0.4% (±48 digits)</td> <td rowspan="2">±0.1% (±12 digits)</td> </tr> <tr> <td>0 to 5V</td> </tr> <tr> <td>1 to 5V</td> </tr> <tr> <td rowspan="3">Current</td> <td>0 to 20mA</td> <td rowspan="3">±0.4% (±16 digits)</td> <td rowspan="3">±0.1% (±4 digits)</td> <td rowspan="3">±0.4% (±48 digits)</td> <td rowspan="3">±0.1% (±12 digits)</td> </tr> <tr> <td>4 to 20mA</td> </tr> <tr> <td>4 to 20mA (extended mode)</td> </tr> </tbody> </table>	Analog input range	Normal resolution mode		High resolution mode		Ambient temperature	0 to 55°C	25±5°C	0 to 55°C	25±5°C	Voltage	0 to 10V	±0.4% (±16 digits)	±0.1% (±4 digits)	±0.4% (±64 digits)	±0.1% (±16 digits)	-10 to 10V	±0.4% (±48 digits)	±0.1% (±12 digits)	0 to 5V	1 to 5V	Current	0 to 20mA	±0.4% (±16 digits)	±0.1% (±4 digits)	±0.4% (±48 digits)	±0.1% (±12 digits)	4 to 20mA	4 to 20mA (extended mode)	○																																																										
Analog input range	Normal resolution mode		High resolution mode																																																																																								
	Ambient temperature	0 to 55°C	25±5°C	0 to 55°C	25±5°C																																																																																						
Voltage	0 to 10V	±0.4% (±16 digits)	±0.1% (±4 digits)	±0.4% (±64 digits)	±0.1% (±16 digits)																																																																																						
	-10 to 10V			±0.4% (±48 digits)	±0.1% (±12 digits)																																																																																						
	0 to 5V																																																																																										
	1 to 5V																																																																																										
Current	0 to 20mA	±0.4% (±16 digits)	±0.1% (±4 digits)	±0.4% (±48 digits)	±0.1% (±12 digits)																																																																																						
	4 to 20mA																																																																																										
	4 to 20mA (extended mode)																																																																																										
Absolute maximum output		Voltage: ±12V Current: 28mA	Voltage: ±12V Current: 21mA	○																																																																																							
Conversion speed		When 1/4000 is set: 1ms/channel When 1/8000 is set: 2ms/channel When 1/12000 is set: 3ms/channel	500μs/channel	○																																																																																							
Output short protection		Available	Available	○																																																																																							
Isolation method		Between input terminal and programmable controller power supply: photocoupler isolation Between channels: not isolated	Between I/O terminal and programmable controller power supply: photocoupler isolation Between I/O channels: not isolated Between external power supply and analog I/O channel: not isolated	○																																																																																							

○ : Compatible, △ : Partial change required, × : Incompatible

Item		A1S63ADA	Q64AD2DA	Compat- ibility	Precautions for replacement
Dielectric withstand voltage		Between input terminal and programmable controller power supply: 500VAC 1 minute	Between I/O terminal and programmable controller power supply: 500VACrms 1 minute	○	
Insulation resistance		Between input terminal and programmable controller power supply: 500VDC 5MΩ or higher	Between I/O terminal and programmable controller power supply: 500VDC 20MΩ or higher	○	
Conversion speed under simple loop control		When 1/4000 is set: 4ms When 1/8000 is set: 7ms When 1/12000 is set: 9ms	-	×	The Q64AD2DA is not equipped with the simple loop control.
Number of I/O occupied points		32 points (I/O assignment: special 32 points)	16 points (I/O assignment: intelligent 16 points)	△	The number of I/O occupied points has been changed to 16 points.
Connection terminal		20-point terminal block	A/D conversion part, D/A conversion part: 18-point terminal block External power supply 24VDC, FG connection: external power supply connector	×	Wiring needs to be changed.
Applicable wire size		0.75 to 1.5mm ² (Applicable tightening torque: 39 to 59N·cm)	A/D conversion part, D/A conversion part: 0.3 to 0.75mm ² External power supply 24VDC, FG connection: Refer to *1.	×	
Applicable solderless terminal		1.25-3, 1.25-YS3A, 2-3.5, 2-YS3A, V1.25-M3, V1.25-YS3A, V2-S3, V2-YS3A	A/D conversion part, D/A conversion part: R1.25-3 (Solderless terminals with an insulation sleeve cannot be used.) External power supply 24VDC, FG connection: None	×	
External power supply	Voltage	-	24VDC ±15% Ripple, spike 500mV _{P-P} or less	×	
	Current consumption		0.19A	×	
	Inrush current		2.5A 150μs or less	×	
Internal current consumption (5VDC)		0.8A	0.17A	○	
Weight		0.3kg	0.23kg	△	

*1 The following table shows the specifications of the applicable wire to the external power supply connector.

Item	Specifications
Applicable wire size	3.3mm ² (AWG12)
Rated multi-wire connection size	Solid wire: 0.2 to 0.8mm ² × 2 wires
	Stranded wire: 0.2 to 0.8mm ² × 2 wires
Screw tightening torque	0.5 to 0.6N·m

4.2.2 Functional comparison

(1) Functions of A/D conversion

○ : Available, - : Not available

Item		Description	A1S63ADA	Q64AD2DA	Precautions for replacement
A/D conversion enable/disable function		Allows specifying whether to enable or disable A/D conversion for each channel. Disabling the conversion on unused channels reduces the sampling time.	○	○	
Sampling processing		Sequentially performs A/D conversion on analog input values for each channel, outputting the digital output value each time.	○	○	
Averaging processing	Time average	Performs averaging processing on A/D conversion in units of time for each channel, and performs digital output of its average value.	○	○	The setting range varies between the time average and count average. Refer to MELSEC-Q Analog I/O Module User's Manual to check the specifications.
	Count average	Performs averaging processing on A/D conversion in units of counts for each channel, and performs digital output of its average value.	○	○	
	Moving average	Performs averaging processing on A/D conversion in units of counts for each channel, with the range moving in response to each sampling processing, and performs digital output of its average value.	-	○	
Range switching function		Allows selection of the input range to be used.	○	○	
Maximum and minimum values hold function		Holds the maximum value and the minimum value of digital values into the module.	-	○	
Input signal error detection function		Detects an analog input value that is out of the setting range.	-	○	
Scaling function		Performs scale conversion on digital output values within a specified range between a scaling upper limit value and a scaling lower limit value. This function reduces the time and effort to create a program of the scale conversion.	-	○	Setting the same scaling upper limit value and scaling lower limit value as those of resolution mode of the A1S63ADA allows use of the same digital output values as in the A1S63ADA.
Logging function		Logs (records) digital output values or scaling values (digital operation values). 10000 points of data can be logged for each channel.	-	○	

(2) Functions of D/A conversion

○ : Available, -: Not available

Item	Description	A1S63ADA	Q64AD2DA	Precautions for replacement
D/A conversion enable/disable function	Allows specifying whether to enable or disable D/A conversion for each channel.	○	○	Disabling the D/A conversion on channels that are not to be used in the Q64AD2DA reduces the conversion cycle.
D/A output enable/disable function	Allows specifying whether to output D/A conversion values or offset values for each channel. The conversion speed remains constant irrespective of the output enabled/disabled state.	○	○	
Range switching function	Allows selection of the range to be used.	○	○	
Analog output HOLD/CLEAR function	Allows setting whether to hold (HOLD) or clear (CLEAR) analog output values depending on the CPU module operating status: RUN, STOP, or a stop error.	○	○	For the A1S63ADA, all the channels are set collectively by means of the HLD/CLR terminal on the front side of the module. For the Q64AD2DA, each channel can be set separately by means of the switch setting (GX Works2).
Analog output test at STOP status of the CPU module	Outputs the analog value converted from a digital value when CH□ Output enable/disable flag is forcibly turned on while the CPU module is in the STOP status.	-	○	
Scaling function	Performs scale conversion on digital input values within a specified range between a D/A conversion scaling upper limit value and a D/A conversion scaling lower limit value. This function reduces the time and effort to create a program of the scale conversion.	-	○	Setting the same scaling upper limit value and scaling lower limit value as those of resolution mode of the A1S63ADA allows use of the same digital output values as in the A1S63ADA.
Shift function	Makes it easy to perform fine adjustments at the system startup. This function adds the preset value to a digital input value and stores it into the buffer memory.	-	○	

(3) Common functions

○ : Available, - : Not available

Item	Description	A1S63ADA	Q64AD2DA	Precautions for replacement
Resolution mode	Switches resolution mode according to the application, permitting selection of the resolution. The settings of resolution mode are to be shared by all the channels.*1	○	-	
Simple loop control (Function expressions)	Converts analog values that are input in CH1 and CH2 into digital values, and performs calculations of the function expression on the converted values. The calculated result is converted to the analog values to output it from CH3.	○	-	
External power supply shutoff detection flag	Turns on while the external power supply is not supplied. If each channel is set to enable the conversion and Operating condition setting request is turned on and off, A/D conversion and D/A conversion are not performed.	-	○	
Error log function	Records up to the 16 errors and alarms that have occurred in the Q64AD2DA, storing them into the buffer memory.	-	○	
Module error collection function	Collects errors and alarms that have occurred in the Q64AD2DA into the CPU module.	-	○	
Error clear function	Allows error clear through the system monitor at the occurrence of an error.	-	○	Can be used by using GX Works2.
Saving/restoring offset/gain values	Makes it possible to save and restore the offset/gain values of the user range setting.	-	○	
Offset/gain setting function	Corrects errors in analog output values and digital output values.	○	○	
Online module change	Allows module replacement without stopping the system.	-	○	

*1 For the A1S63ADA, both voltage and current can be selected from 1/4000, 1/8000, or 1/12000 in the resolution mode settings.

On the other hand, the Q64AD2DA provides two modes: normal resolution mode and high resolution mode. The same digital values as those of the A1S63ADA can be used by setting the same scaling upper limit value and scaling lower limit value as those of resolution mode of the A1S63ADA using the scaling function.

☒ Point

The Q64AD2DA of the replacement modules is not equipped with the simple loop control (Function expressions) function.

Continuous use of the simple loop control (Function expressions) which has been used with the A1S63ADA requires preparation of a sequence program. (Refer to Section 4.1.)

4.2.3 I/O signal comparison

Because the I/O signals differ between the modules, the sequence program needs to be changed. For details on the I/O signals and the sequence program, refer to Analog Input/Output Module User's Manual Q64AD2DA.

A1S63ADA				Q64AD2DA				
Device No.	Signal name	Device No.	Signal name	Device No.	Signal name	Device No.	Signal name	
X0	WDT error	Y0	Unusable	X0	Module ready	Y0	Use prohibited	
X1	Conversion READY	Y1		X1	CH1 Logging hold flag	Y1	CH1 Logging hold request	
X2	Error detection	Y2		X2	CH2 Logging hold flag	Y2	CH2 Logging hold request	
X3	CH3 output upper limit value hold	Y3		X3	CH3 Logging hold flag	Y3	CH3 Logging hold request	
X4	CH3 output lower limit value hold	Y4		X4	CH4 Logging hold flag	Y4	CH4 Logging hold request	
X5	Simple loop control in execution	Y5		X5	Use prohibited	Y5	CH5 Output enable/disable flag	
X6	Unusable	Y6		X6	External power off flag	Y6	CH6 Output enable/disable flag	
X7		Y7		X7	Input signal error detection signal	Y7	Use prohibited	
X8	Offset/gain selection	Y8		X8	High resolution mode status flag	Y8	Use prohibited	
X9		Y9		X9	Operating condition setting completion flag	Y9		Operating condition setting request
XA		YA		XA	Use prohibited	YA	Use prohibited	
XB		YB		XB		YB		
XC		YC		XC		YC		
XD		Unusable		YD	XD	Maximum and minimum values reset completion flag	YD	Maximum and minimum values reset request
XE				YE	XE	A/D conversion completed flag	YE	Use prohibited
XF	YF			XF	Error flag	YF	Error clear request	
X10	Y10							
X11	Y11							
X12	Y12							
X13	Y13							
X14	Unusable		Y14					
X15			Y15					
X16			Y16					
X17		Y17						
X18		Y18						
X19		Y19						
X1A	Unusable	Y1A						
X1B		Y1B						
X1C		Y1C						
X1D	Y1D							
X1E	Y1E							
X1F	Y1F							

4.2.4 Buffer memory address comparison

Because the assignment of buffer memory differs between the modules, the sequence program needs to be changed.

For details on the buffer memory and the sequence program, refer to Analog Input/Output Module User's Manual Q64AD2DA.

A1S63ADA			Q64AD2DA							
Address (decimal)	Name	Read/write	Address (decimal)				Name	Read/write		
			CH1	CH2	CH3	CH4				
0	A-D/A conversion enable/disable setting	R/W	0	200	400	600	A/D conversion enable/disable setting	R/W		
1	A-D conversion averaging setting		1	201	401	601	Averaging process method setting	R/W		
2	CH1 averaging time/count setting		2	202	402	602	Averaging process (time/number of times) setting	R/W		
3	CH2 averaging time/count setting		3	203	403	603	System area	-		
4	CH3 output upper limit value setting		to	to	to	to				
5	CH3 output lower limit value setting		9	209	409	609				
6	Simple loop control type setting		10	210	410	610				
7	Constant A setting		11	211	411	611	A/D conversion scaling enable/disable setting	R/W		
8	Constant B setting		12	212	412	612	A/D conversion scaling lower limit value	R/W		
9	Constant C setting		13	213	413	613	A/D conversion scaling upper limit value	R/W		
10	CH3 digital value setting		14	214	414	614	Shifting amount to conversion value	R/W		
11	CH1 A-D conversion digital value	R	to	to	to	to	System area	-		
12	CH2 A-D conversion digital value		19	219	419	619				
13	Simple loop control output calculation value		20	220	420	620	Input signal error detection setting	R/W		
14	Resolution setting		21	221	421	621	Input signal error detection setting value	R/W		
15	A-D conversion completed flag		22	222	422	622	System area	-		
16	Error code	to	to	to	to					
17	Coordinate points setting	29	229	429	629					
18	Point 0	CH1 coordinates	30	230	430	630	Logging enable/disable setting	R/W		
19			CH3 coordinates	31	231	431	631	Logging cycle setting value	R/W	
20	Point 1	CH1 coordinates	32	232	432	632	Logging cycle unit setting	R/W		
21			CH3 coordinates	33	233	433	633	Logging data setting	R/W	
22	Point 2	CH1 coordinates	34	234	434	634	Logging points after trigger	R/W		
23			CH3 coordinates	35	235	435	635	Level trigger condition setting	R/W	
24	Point 3	CH1 coordinates	36	236	436	636	Trigger data	R/W		
25			CH3 coordinates	37	237	437	637	Trigger setting value	R/W	
26	Point 4	CH1 coordinates	38	238	438	638	System area	-		
27			CH3 coordinates	99	299	499			699	
28	Point 5	CH1 coordinates	100	300	500	700			Digital output value	R
29			CH3 coordinates	101	301	501			701	System area
30	Point 6	CH1 coordinates	102	302	502	702	Scaling value	R		
31			CH3 coordinates	103	303	503	703	System area	-	
32	Point 7	CH1 coordinates	104	304	504	704	Maximum digital output value	R		
33			CH3 coordinates	105	305	505	705	System area	-	
34	Point 8	CH1 coordinates	106	306	506	706	Minimum digital output value	R		
35			CH3 coordinates	107	307	507	707	System area	-	
36	Point 9	CH1 coordinates	108	308	508	708	System area	-		
37			CH3 coordinates	109	309	509	709	Maximum scaling value	R	
			110	310	510	710	System area	-		
			111	311	511	711	Minimum scaling value	R		
			112	312	512	712	System area	-		
			113	313	513	713	Setting range	R		
			114	314	514	714	A/D conversion completed flag	R		
			115	315	515	715	Input signal error detection flag	R		
			to	to	to	to	System area	-		
			119	319	519	719				
			120	320	520	720			Oldest pointer	R
			121	321	521	721	Latest pointer	R		
			122	322	522	722	Logging data points	R		
			123	323	523	723	Trigger pointer	R		

Q64AD2DA							
Address (decimal)				Name			Read/write
CH1	CH2	CH3	CH4				
124 to 189	324 to 389	524 to 589	724 to 789	System area			-
190	390	590	790	Latest error code			R
191	391	591	791	Error time	First two digits of the year	Last two digits of the year	R
192	392	592	792		Month	Day	R
193	393	593	793		Hour	Minute	R
194	394	594	794		Second	Day of the week	R
195 to 199	395 to 399	595 to 599	795 to 799	System area			-

Q64AD2DA					
Address (decimal)		Name			Read/write
CH5	CH6				
800	1000	D/A conversion enable/disable setting			R/W
801	1001	System area			-
802	1002	Digital input value			R/W
803 to 809	1003 to 1009	System area			-
810	1010	D/A conversion scaling enable/disable setting			R/W
811	1011	D/A conversion scaling lower limit value			R/W
812	1012	D/A conversion scaling upper limit value			R/W
813	1013	Shifting amount to input value			R/W
814 to 899	1014 to 1099	System area			-
900	1100	Set value check code			R
901	1101	System area			-
902	1102	Real conversion digital value			R
903 to 911	1103 to 1111	System area			-
912	1112	Setting range			R
913	1113	HOLD/CLEAR function setting			R
914 to 989	1114 to 1189	System area			-
990	1190	Latest error code			R
991	1191	Error time	First two digits of the year	Last two digits of the year	R
992	1192		Month	Day	R
993	1193		Hour	Minute	R
994	1194		Second	Day of the week	R
995 to 999	1195 to 1199	System area			-

Q64AD2DA		
Address (decimal)	Name	Read/write
1200 to 1599	System area	-
1600	Level data 0	R/W
1601	Level data 1	R/W
1602	Level data 2	R/W
1603	Level data 3	R/W
1604	Level data 4	R/W
1605	Level data 5	R/W
1606	Level data 6	R/W
1607	Level data 7	R/W
1608	Level data 8	R/W
1609	Level data 9	R/W
1610 to 1699	System area	-
1700	CH1 Digital output value	R
1701	CH2 Digital output value	R
1702	CH3 Digital output value	R
1703	CH4 Digital output value	R
1704 to 1709	System area	-
1710	CH1 Scaling value	R
1711	CH2 Scaling value	R
1712	CH3 Scaling value	R
1713	CH4 Scaling value	R
1714 to 1719	System area	-
1720	CH1 Maximum digital output value	R
1721	CH1 Minimum digital output value	R
1722	CH2 Maximum digital output value	R
1723	CH2 Minimum digital output value	R
1724	CH3 Maximum digital output value	R
1725	CH3 Minimum digital output value	R
1726	CH4 Maximum digital output value	R
1727	CH4 Minimum digital output value	R
1728 to 1739	System area	-
1740	CH1 Maximum scaling value	R
1741	CH1 Minimum scaling value	R
1742	CH2 Maximum scaling value	R
1743	CH2 Minimum scaling value	R
1744	CH3 Maximum scaling value	R
1745	CH3 Minimum scaling value	R
1746	CH4 Maximum scaling value	R
1747	CH4 Minimum scaling value	R
1748 to 1763	System area	-
1764	CH5 Set value check code	R
1765	CH6 Set value check code	R
1766 to 1773	System area	-
1774	CH5 Real conversion digital value	R
1775	CH6 Real conversion digital value	R
1776 to 1789	System area	-

Q64AD2DA			
Address (decimal)	Name		Read/write
1790	Latest error code		R
1791	Error time	First two digits of the year	
1792		Month	
1793		Hour	
1794		Second	
1795 to 1799	System area		

Q64AD2DA				
Address (decimal)	Name			Read/write
1800	Latest address of error history			R
1801 to 1809	System area			-
1810	Error code			R
1811	History 1	Error time	First two digits of the year	
1812			Month	
1813			Hour	
1814			Second	
1815 to 1819	System area			-
1820	Error code			R
1821	History 2	Error time	First two digits of the year	
1822			Month	
1823			Hour	
1824			Second	
1825 to 1829	System area			-
1830	Error code			R
1831	History 3	Error time	First two digits of the year	
1832			Month	
1833			Hour	
1834			Second	
1835 to 1839	System area			-
1840	Error code			R
1841	History 4	Error time	First two digits of the year	
1842			Month	
1843			Hour	
1844			Second	
1845 to 1849	System area			-
1850	Error code			R
1851	History 5	Error time	First two digits of the year	
1852			Month	
1853			Hour	
1854			Second	
1855 to 1859	System area			-

Q64AD2DA					
Address (decimal)	Name			Read/write	
1860	History 6	Error time	Error code		R
1861			First two digits of the year	Last two digits of the year	
1862			Month	Day	
1863			Hour	Minute	
1864			Second	Day of the week	
1865 to 1869	System area			-	
1870	History 7	Error time	Error code		R
1871			First two digits of the year	Last two digits of the year	
1872			Month	Day	
1873			Hour	Minute	
1874			Second	Day of the week	
1875 to 1879	System area			-	
1880	History 8	Error time	Error code		R
1881			First two digits of the year	Last two digits of the year	
1882			Month	Day	
1883			Hour	Minute	
1884			Second	Day of the week	
1885 to 1889	System area			-	
1890	History 9	Error time	Error code		R
1891			First two digits of the year	Last two digits of the year	
1892			Month	Day	
1893			Hour	Minute	
1894			Second	Day of the week	
1895 to 1899	System area			-	
1900	History 10	Error time	Error code		R
1901			First two digits of the year	Last two digits of the year	
1902			Month	Day	
1903			Hour	Minute	
1904			Second	Day of the week	
1905 to 1909	System area			-	
1910	History 11	Error time	Error code		R
1911			First two digits of the year	Last two digits of the year	
1912			Month	Day	
1913			Hour	Minute	
1914			Second	Day of the week	

Q64AD2DA					
Address (decimal)	Name			Read/write	
1915 to 1919	System area			-	
1920	History 12	Error code			R
1921		Error time	First two digits of the year	Last two digits of the year	
1922			Month	Day	
1923			Hour	Minute	
1924			Second	Day of the week	
1925 to 1929	System area			-	
1930	History 13	Error code			R
1931		Error time	First two digits of the year	Last two digits of the year	
1932			Month	Day	
1933			Hour	Minute	
1934			Second	Day of the week	
1935 to 1939	System area			-	
1940	History 14	Error code			R
1941		Error time	First two digits of the year	Last two digits of the year	
1942			Month	Day	
1943			Hour	Minute	
1944			Second	Day of the week	
1945 to 1949	System area			-	
1950	History 15	Error code			R
1951		Error time	First two digits of the year	Last two digits of the year	
1952			Month	Day	
1953			Hour	Minute	
1954			Second	Day of the week	
1955 to 1959	System area			-	
1960	History 16	Error code			R
1961		Error time	First two digits of the year	Last two digits of the year	
1962			Month	Day	
1963			Hour	Minute	
1964			Second	Day of the week	
5000 to 14999	CH1 Logging data			R	
15000 to 24999	CH2 Logging data			R	
25000 to 34999	CH3 Logging data			R	

Q64AD2DA		
Address (decimal)	Name	Read/write
35000 to 44999	CH4 Logging data	R
45000 to 49999	System area	-

4.3 A1S66ADA

4.3.1 Performance specifications comparison

○ : Compatible, △ : Partial change required, × : Incompatible

Item	A1S66ADA	Q64AD2DA	Compatibility	Precautions for replacement																																																																										
Number of analog input points	4 channels/module	4 channels/module	○																																																																											
Analog input	Voltage -10 to 0 to 10VDC (Input resistance value: 1MΩ)	-10 to 10VDC (Input resistance value: 1MΩ)	○																																																																											
	Current 0 to 20mADC (Input resistance value: 250Ω)	0 to 20mADC (Input resistance value: 250Ω)	○																																																																											
Digital output	12 bit binary value 0 to 4095	Normal resolution mode: -96 to 4095, -4096 to 4095, -1096 to 4595 High resolution mode: -384 to 16383, -288 to 12287, -16384 to 16383, -3288 to 13787	△																																																																											
I/O characteristics	<table border="1"> <thead> <tr> <th colspan="2">Analog input range</th> <th>Digital output value</th> <th>Resolution</th> </tr> </thead> <tbody> <tr> <td rowspan="4">Voltage</td> <td>0 to 10V</td> <td rowspan="4">0 to 4000</td> <td>2.5mV</td> </tr> <tr> <td>0 to 5V</td> <td>1.25mV</td> </tr> <tr> <td>1 to 5V</td> <td>1.0mV</td> </tr> <tr> <td>-10 to 10V</td> <td>5.0mV</td> </tr> <tr> <td rowspan="2">Current</td> <td>0 to 20mA</td> <td></td> <td>5μA</td> </tr> <tr> <td>4 to 20mA</td> <td></td> <td>4μA</td> </tr> </tbody> </table>	Analog input range		Digital output value	Resolution	Voltage	0 to 10V	0 to 4000	2.5mV	0 to 5V	1.25mV	1 to 5V	1.0mV	-10 to 10V	5.0mV	Current	0 to 20mA		5μA	4 to 20mA		4μA	<table border="1"> <thead> <tr> <th rowspan="2">Input</th> <th rowspan="2">Analog input range</th> <th colspan="2">Normal resolution mode</th> <th colspan="2">High resolution mode</th> </tr> <tr> <th>Digital output value</th> <th>Maximum resolution</th> <th>Digital output value</th> <th>Maximum resolution</th> </tr> </thead> <tbody> <tr> <td rowspan="3">Voltage</td> <td>0 to 10V</td> <td>0 to 4000</td> <td>2.5mV</td> <td>0 to 16000</td> <td>0.625mV</td> </tr> <tr> <td>0 to 5V</td> <td></td> <td>1.25mV</td> <td>0 to 12000</td> <td>0.416mV</td> </tr> <tr> <td>1 to 5V</td> <td></td> <td>1.0mV</td> <td></td> <td>0.333mV</td> </tr> <tr> <td rowspan="3">Voltage</td> <td>-10 to 10V</td> <td>-4000 to 4000</td> <td>2.5mV</td> <td>-16000 to 16000</td> <td>0.625mV</td> </tr> <tr> <td>1 to 5V (extended mode)</td> <td>-1000 to 4500</td> <td>1.0mV</td> <td>-3000 to 13500</td> <td>0.333mV</td> </tr> <tr> <td rowspan="3">Current</td> <td>0 to 20mA</td> <td>0 to 4000</td> <td>5μA</td> <td>0 to 12000</td> <td>1.66μA</td> </tr> <tr> <td>4 to 20mA</td> <td></td> <td>4μA</td> <td></td> <td>1.33μA</td> </tr> <tr> <td>4 to 20mA (extended mode)</td> <td>-1000 to 4500</td> <td>4μA</td> <td>-3000 to 13500</td> <td>1.33μA</td> </tr> </tbody> </table>	Input	Analog input range	Normal resolution mode		High resolution mode		Digital output value	Maximum resolution	Digital output value	Maximum resolution	Voltage	0 to 10V	0 to 4000	2.5mV	0 to 16000	0.625mV	0 to 5V		1.25mV	0 to 12000	0.416mV	1 to 5V		1.0mV		0.333mV	Voltage	-10 to 10V	-4000 to 4000	2.5mV	-16000 to 16000	0.625mV	1 to 5V (extended mode)	-1000 to 4500	1.0mV	-3000 to 13500	0.333mV	Current	0 to 20mA	0 to 4000	5μA	0 to 12000	1.66μA	4 to 20mA		4μA		1.33μA	4 to 20mA (extended mode)	-1000 to 4500	4μA	-3000 to 13500	1.33μA	△	A resolution other than 1/4000 of the AnS series and Q series requires the support of a sequence program or the scaling function.
Analog input range		Digital output value	Resolution																																																																											
Voltage	0 to 10V	0 to 4000	2.5mV																																																																											
	0 to 5V		1.25mV																																																																											
	1 to 5V		1.0mV																																																																											
	-10 to 10V		5.0mV																																																																											
Current	0 to 20mA		5μA																																																																											
	4 to 20mA		4μA																																																																											
Input	Analog input range	Normal resolution mode		High resolution mode																																																																										
		Digital output value	Maximum resolution	Digital output value	Maximum resolution																																																																									
Voltage	0 to 10V	0 to 4000	2.5mV	0 to 16000	0.625mV																																																																									
	0 to 5V		1.25mV	0 to 12000	0.416mV																																																																									
	1 to 5V		1.0mV		0.333mV																																																																									
Voltage	-10 to 10V	-4000 to 4000	2.5mV	-16000 to 16000	0.625mV																																																																									
	1 to 5V (extended mode)	-1000 to 4500	1.0mV	-3000 to 13500	0.333mV																																																																									
	Current	0 to 20mA	0 to 4000	5μA	0 to 12000	1.66μA																																																																								
4 to 20mA			4μA		1.33μA																																																																									
4 to 20mA (extended mode)		-1000 to 4500	4μA	-3000 to 13500	1.33μA																																																																									
Resolution			○																																																																											
Overall accuracy (accuracy at maximum analog output value)	Within ±1% (±40)	<table border="1"> <thead> <tr> <th>Analog input range</th> <th colspan="2">Normal resolution mode</th> <th colspan="2">High resolution mode</th> </tr> </thead> <tbody> <tr> <td>Ambient temperature</td> <td>0 to 55°C</td> <td>25±5°C</td> <td>0 to 55°C</td> <td>25±5°C</td> </tr> <tr> <td rowspan="4">Voltage</td> <td>0 to 10V</td> <td rowspan="4">±0.4% (±16 digits)</td> <td rowspan="4">±0.1% (±4 digits)</td> <td>±0.4% (±64 digits)</td> </tr> <tr> <td>-10 to 10V</td> <td>±0.1% (±16 digits)</td> </tr> <tr> <td>0 to 5V</td> <td></td> </tr> <tr> <td>1 to 5V (extended mode)</td> <td>±0.4% (±48 digits)</td> <td>±0.1% (±12 digits)</td> </tr> <tr> <td rowspan="3">Current</td> <td>0 to 20mA</td> <td></td> <td></td> <td></td> </tr> <tr> <td>4 to 20mA</td> <td></td> <td></td> <td></td> </tr> <tr> <td>4 to 20mA (extended mode)</td> <td></td> <td></td> <td></td> </tr> </tbody> </table>	Analog input range	Normal resolution mode		High resolution mode		Ambient temperature	0 to 55°C	25±5°C	0 to 55°C	25±5°C	Voltage	0 to 10V	±0.4% (±16 digits)	±0.1% (±4 digits)	±0.4% (±64 digits)	-10 to 10V	±0.1% (±16 digits)	0 to 5V		1 to 5V (extended mode)	±0.4% (±48 digits)	±0.1% (±12 digits)	Current	0 to 20mA				4 to 20mA				4 to 20mA (extended mode)				○																																								
Analog input range	Normal resolution mode		High resolution mode																																																																											
Ambient temperature	0 to 55°C	25±5°C	0 to 55°C	25±5°C																																																																										
Voltage	0 to 10V	±0.4% (±16 digits)	±0.1% (±4 digits)	±0.4% (±64 digits)																																																																										
	-10 to 10V			±0.1% (±16 digits)																																																																										
	0 to 5V																																																																													
	1 to 5V (extended mode)			±0.4% (±48 digits)	±0.1% (±12 digits)																																																																									
Current	0 to 20mA																																																																													
	4 to 20mA																																																																													
	4 to 20mA (extended mode)																																																																													
Maximum conversion speed	400μs or less/4 channels (Sampling cycle: 80μs/channel)	500μs/channel	○																																																																											
Absolute maximum input	Voltage ±15V Current 30mA	Voltage ±15V Current 30mA	○																																																																											

○ : Compatible, △ : Partial change required, × : Incompatible

Item	A1S66ADA	Q64AD2DA	Compatibility	Precautions for replacement																																																																							
Number of analog output points	2 channels/module	2 channels/module	○																																																																								
Digital input	12 bit binary value 0 to 4000	Normal resolution mode: -96 to 4095, -4096 to 4095, -1096 to 4595 High resolution mode: -384 to 16383, -288 to 12287, -16384 to 16383, -3288 to 13787	○																																																																								
Analog output	Voltage (External load resistance value: 2kΩ to 1MΩ)	-10 to 10VDC (External load resistance value: 1kΩ to 1MΩ)	○																																																																								
	Current (External load resistance value: 0 to 600Ω)	0 to 20mADC (External load resistance value: 0 to 600Ω)																																																																									
I/O characteristics			○																																																																								
Maximum resolution	<table border="1"> <thead> <tr> <th colspan="2">Analog output range</th> <th>Digital input value</th> <th>Resolution</th> </tr> </thead> <tbody> <tr> <td rowspan="4">Voltage</td> <td>0 to 10V</td> <td rowspan="4">0 to 4000</td> <td>2.5mV</td> </tr> <tr> <td>0 to 5V</td> <td>1.25mV</td> </tr> <tr> <td>1 to 5V</td> <td>1.0mV</td> </tr> <tr> <td>-10 to 10V</td> <td>5.0mV</td> </tr> <tr> <td rowspan="2">Current</td> <td>0 to 20mA</td> <td></td> <td>5μA</td> </tr> <tr> <td>4 to 20mA</td> <td></td> <td>4μA</td> </tr> </tbody> </table>	Analog output range		Digital input value	Resolution	Voltage	0 to 10V	0 to 4000	2.5mV	0 to 5V	1.25mV	1 to 5V	1.0mV	-10 to 10V	5.0mV	Current	0 to 20mA		5μA	4 to 20mA		4μA	<table border="1"> <thead> <tr> <th rowspan="2">Input</th> <th rowspan="2">Analog input range</th> <th colspan="2">Normal resolution mode</th> <th colspan="2">High resolution mode</th> </tr> <tr> <th>Digital output value</th> <th>Maximum resolution</th> <th>Digital output value</th> <th>Maximum resolution</th> </tr> </thead> <tbody> <tr> <td rowspan="4">Voltage</td> <td>0 to 10V</td> <td rowspan="4">0 to 4000</td> <td>2.5mV</td> <td>0 to 16000</td> <td>0.625mV</td> </tr> <tr> <td>0 to 5V</td> <td>1.25mV</td> <td>0 to 12000</td> <td>0.416mV</td> </tr> <tr> <td>1 to 5V</td> <td>1.0mV</td> <td>12000</td> <td>0.333mV</td> </tr> <tr> <td>-10 to 10V</td> <td>-4000 to 4000</td> <td>2.5mV</td> <td>-16000 to 16000</td> <td>0.625mV</td> </tr> <tr> <td rowspan="4">Current</td> <td>1 to 5V (extended mode)</td> <td>-1000 to 4500</td> <td>1.0mV</td> <td>-3000 to 13500</td> <td>0.333mV</td> </tr> <tr> <td>0 to 20mA</td> <td>0 to 4000</td> <td>5μA</td> <td>0 to 12000</td> <td>1.66μA</td> </tr> <tr> <td>4 to 20mA</td> <td>4000</td> <td>4μA</td> <td>12000</td> <td>1.33μA</td> </tr> <tr> <td>4 to 20mA (extended mode)</td> <td>-1000 to 4500</td> <td>4μA</td> <td>-3000 to 13500</td> <td>1.33μA</td> </tr> </tbody> </table>	Input	Analog input range	Normal resolution mode		High resolution mode		Digital output value	Maximum resolution	Digital output value	Maximum resolution	Voltage	0 to 10V	0 to 4000	2.5mV	0 to 16000	0.625mV	0 to 5V	1.25mV	0 to 12000	0.416mV	1 to 5V	1.0mV	12000	0.333mV	-10 to 10V	-4000 to 4000	2.5mV	-16000 to 16000	0.625mV	Current	1 to 5V (extended mode)	-1000 to 4500	1.0mV	-3000 to 13500	0.333mV	0 to 20mA	0 to 4000	5μA	0 to 12000	1.66μA	4 to 20mA	4000	4μA	12000	1.33μA	4 to 20mA (extended mode)	-1000 to 4500	4μA	-3000 to 13500	1.33μA	△	Because of the resolution difference between the AnS series and L series, the support of a sequence program, user range settings, or the scaling function is required. (Refer to Appendix 4.)
	Analog output range		Digital input value	Resolution																																																																							
Voltage	0 to 10V	0 to 4000	2.5mV																																																																								
	0 to 5V		1.25mV																																																																								
	1 to 5V		1.0mV																																																																								
	-10 to 10V		5.0mV																																																																								
Current	0 to 20mA		5μA																																																																								
	4 to 20mA		4μA																																																																								
Input	Analog input range	Normal resolution mode		High resolution mode																																																																							
		Digital output value	Maximum resolution	Digital output value	Maximum resolution																																																																						
Voltage	0 to 10V	0 to 4000	2.5mV	0 to 16000	0.625mV																																																																						
	0 to 5V		1.25mV	0 to 12000	0.416mV																																																																						
	1 to 5V		1.0mV	12000	0.333mV																																																																						
	-10 to 10V		-4000 to 4000	2.5mV	-16000 to 16000	0.625mV																																																																					
Current	1 to 5V (extended mode)	-1000 to 4500	1.0mV	-3000 to 13500	0.333mV																																																																						
	0 to 20mA	0 to 4000	5μA	0 to 12000	1.66μA																																																																						
	4 to 20mA	4000	4μA	12000	1.33μA																																																																						
	4 to 20mA (extended mode)	-1000 to 4500	4μA	-3000 to 13500	1.33μA																																																																						
Overall accuracy (accuracy at maximum analog output value)	±1% (Voltage: ±100mV, Current: ±200μA)	<table border="1"> <thead> <tr> <th>Analog input range</th> <th colspan="2">Normal resolution mode</th> <th colspan="2">High resolution mode</th> </tr> <tr> <th>Ambient temperature</th> <td>0 to 55°C</td> <td>25±5°C</td> <td>0 to 55°C</td> <td>25±5°C</td> </tr> </thead> <tbody> <tr> <td rowspan="4">Voltage</td> <td>0 to 10V</td> <td rowspan="4">±0.4% (±16 digits)</td> <td rowspan="4">±0.1% (±4 digits)</td> <td>±0.4% (±64 digits)</td> </tr> <tr> <td>-10 to 10V</td> <td>±0.1% (±16 digits)</td> </tr> <tr> <td>0 to 5V</td> <td rowspan="2">±0.4% (±48 digits)</td> </tr> <tr> <td>1 to 5V (extended mode)</td> <td>±0.1% (±12 digits)</td> </tr> <tr> <td rowspan="3">Current</td> <td>0 to 20mA</td> <td rowspan="3">±0.4% (±16 digits)</td> <td rowspan="3">±0.1% (±4 digits)</td> <td>±0.4% (±48 digits)</td> </tr> <tr> <td>4 to 20mA</td> <td rowspan="2">±0.1% (±12 digits)</td> </tr> <tr> <td>4 to 20mA (extended mode)</td> </tr> </tbody> </table>	Analog input range	Normal resolution mode		High resolution mode		Ambient temperature	0 to 55°C	25±5°C	0 to 55°C	25±5°C	Voltage	0 to 10V	±0.4% (±16 digits)	±0.1% (±4 digits)	±0.4% (±64 digits)	-10 to 10V	±0.1% (±16 digits)	0 to 5V	±0.4% (±48 digits)	1 to 5V (extended mode)	±0.1% (±12 digits)	Current	0 to 20mA	±0.4% (±16 digits)	±0.1% (±4 digits)	±0.4% (±48 digits)	4 to 20mA	±0.1% (±12 digits)	4 to 20mA (extended mode)	○																																											
Analog input range	Normal resolution mode		High resolution mode																																																																								
Ambient temperature	0 to 55°C	25±5°C	0 to 55°C	25±5°C																																																																							
Voltage	0 to 10V	±0.4% (±16 digits)	±0.1% (±4 digits)	±0.4% (±64 digits)																																																																							
	-10 to 10V			±0.1% (±16 digits)																																																																							
	0 to 5V			±0.4% (±48 digits)																																																																							
	1 to 5V (extended mode)				±0.1% (±12 digits)																																																																						
Current	0 to 20mA	±0.4% (±16 digits)	±0.1% (±4 digits)	±0.4% (±48 digits)																																																																							
	4 to 20mA			±0.1% (±12 digits)																																																																							
	4 to 20mA (extended mode)																																																																										
Conversion speed	240μs or less/2 channels (Sampling cycle: 80μs/channel)	500μs/channel	○																																																																								
Absolute maximum output	Voltage ±12V Current 28mA	Voltage ±12V Current 21mA	○																																																																								
Output short protection	Available	Available	○																																																																								
Isolation method	Between input terminal and programmable controller power supply: photocoupler isolation Between channels: not isolated	Between I/O terminal and programmable controller power supply: photocoupler isolation Between I/O channels: not isolated Between external power supply and analog I/O channel: not isolated	○																																																																								
Dielectric withstand voltage	Between input terminal and programmable controller power supply: 500VAC 1 minute	Between I/O terminal and programmable controller power supply: 500VACrms 1 minute	○																																																																								

○ : Compatible, △ : Partial change required, × : Incompatible

Item	A1S66ADA	Q64AD2DA	Compatibility	Precautions for replacement
Insulation resistance	Between input terminal and programmable controller power supply: 500VDC 5MΩ or higher	Between I/O terminal and programmable controller power supply: 500VDC 20MΩ or higher	○	
Number of I/O occupied points	64 points (input 64 points, output 64 points) (I/O assignment: output 64 points)	16 points (I/O assignment: intelligent 16 points)	△	The number of I/O occupied points has been changed to 16 points.
Connection terminal	20-point terminal block	A/D conversion part, D/A conversion part: 18-point terminal block External power supply 24VDC, FG connection: external power supply connector	×	Wiring needs to be changed.
Applicable wire size	0.75 to 1.25mm ² (Applicable tightening torque: 39 to 59N•cm)	A/D conversion part, D/A conversion part: 0.3 to 0.75mm ² External power supply 24VDC, FG connection: Refer to *1.	×	
Applicable solderless terminal	1.25-3, 1.25-YS3, 2-3.5, 2-YS3A V1.25-M3, V1.25-YS3A, V2-S3, V2-YS3A	A/D conversion part, D/A conversion part: R1.25-3 (Solderless terminals with an insulation sleeve cannot be used.) External power supply 24VDC, FG connection: None	×	
External power supply	Voltage	21.6 to 26.4VDC	24VDC ±15% Ripple, spike 500mV _{P-P} or less	○
	Current consumption	0.16A	0.19A	○
	Inrush current	-	2.5A 150μs or less	△
Internal current consumption (5VDC)	0.21A	0.17A	○	
Weight	0.33kg	0.23kg	△	

*1 The following table shows the specifications of the applicable wire to the external power supply connector.

Item	Specifications
Applicable wire size	3.3mm ² (AWG12)
Rated multi-wire connection size	Solid wire: 0.2 to 0.8mm ² × 2 wires
	Stranded wire: 0.2 to 0.8mm ² × 2 wires
Screw tightening torque	0.5 to 0.6N•m

4.3.2 Functional comparison

(1) Functions of A/D conversion

○ : Available, - : Not available

Item	Description	A1S66ADA	Q64AD2DA	Precautions for replacement
A/D conversion enable/disable function	Allows specifying whether to enable or disable A/D conversion for each channel. Disabling the conversion on unused channels reduces the sampling time.	-	○	
Sampling processing	Sequentially performs A/D conversion on analog input values for each channel, outputting the digital output value each time.	-	○	
Averaging processing	Time average	-	○	
	Count average	-	○	
	Moving average	-	○	
Range switching function	Allows selection of the input range to be used.	○	○	
Maximum and minimum values hold function	Holds the maximum value and the minimum value of digital values into the module.	-	○	
Input signal error detection function	Detects an analog input value that is out of the setting range.	-	○	
Scaling function	Performs scale conversion on digital output values within a specified range between a scaling upper limit value and a scaling lower limit value. This function reduces the time and effort to create a program of the scale conversion.	-	○	Setting the same scaling upper limit value and scaling lower limit value as those of resolution mode of the A1S66ADA allows use of the same digital output values as in the A1S66ADA.
Logging function	Logs (records) digital output values or scaling values (digital operation values). 10000 points of data can be logged for each channel.	-	○	

(2) Functions of D/A conversion

○ : Available, - : Not available

Item	Description	A1S66ADA	Q64AD2DA	Precautions for replacement
D/A conversion enable/disable function	Allows specifying whether to enable or disable D/A conversion for each channel. In the Q64AD2DA, disabling the D/A conversion on unused channels reduces the conversion cycle.	-	○	
D/A output enable/disable function	Allows specifying whether to output D/A conversion values or 0V/0mA for each channel. The conversion speed remains constant irrespective of the output enabled/disabled state.	○	-	The output with D/A output disabled differs each other.
	Allows specifying whether to output D/A conversion values or offset values for each channel. The conversion speed remains constant irrespective of the output enabled/disabled state.	-	○	
Range switching function	Allows selection of the range to be used.	○	○	
Analog output HOLD/CLEAR function	Allows setting whether to hold (HOLD) or clear (CLEAR) analog output values depending on the CPU module operating status: RUN, STOP, or a stop error.	-	○	
Analog output test at STOP status of the CPU module	Outputs the analog value converted from a digital value when CH□ Output enable/disable flag is forcibly turned on while the CPU module is in the STOP status.	-	○	
Scaling function	Performs scale conversion on digital input values within a specified range between a D/A conversion scaling upper limit value and a D/A conversion scaling lower limit value. This function reduces the time and effort to create a program of the scale conversion.	-	○	Setting the same scaling upper limit value and scaling lower limit value as those of resolution mode of the A1S66ADA allows use of the same digital output values as in the A1S66ADA.
Warning output function	Outputs a warning when a digital output value is out of the preset range.	-	○	
Wave output function	Takes in the waveform data prepared beforehand (digital input value), and performs analog output at the set conversion cycle.	-	○	

(3) Common functions

○ : Available, - : Not available

Item	Description	A1S66ADA	Q64AD2DA	Precautions for replacement
External power supply READY flag	Turns on when the external power supply 24VDC is supplied. If external power supply READY flag (X7) is off, A/D conversion and D/A conversion are not performed.	-	○	
Error log function	Records up to the 16 errors and alarms that have occurred in the Q64AD2DA, storing them into the buffer memory.	-	○	
Module error collection function	Collects errors and alarms that have occurred in the Q64AD2DA into the CPU module.	-	○	
Error clear function	Allows error clear through the system monitor at the occurrence of an error.	-	○	Can be used by using GX Works2.
Saving/restoring offset/gain values	Makes it possible to save and restore the offset/gain values of the user range setting.	-	○	
Offset/gain setting function	Corrects errors in analog output values and digital output values.	○	○	
Online module change	Allows module replacement without stopping the system.	-	○	

4.3.3 I/O signal comparison

Because the I/O signals differ between the modules, the sequence program needs to be changed. For details on the I/O signals and the sequence program, refer to Analog Input/Output Module User's Manual Q64AD2DA.

A1S66ADA				Q64AD2DA			
Device No.	Signal name	Device No.	Signal name	Device No.	Signal name	Device No.	Signal name
X0	CH3 digital output value	Y0	CH1 digital value setting	X0	Module ready	Y0	Use prohibited
X1		Y1		X1	CH1 Logging hold flag	Y1	CH1 Logging hold request
X2		Y2		X2	CH2 Logging hold flag	Y2	CH2 Logging hold request
X3		Y3		X3	CH3 Logging hold flag	Y3	CH3 Logging hold request
X4		Y4		X4	CH4 Logging hold flag	Y4	CH4 Logging hold request
X5		Y5		X5	Use prohibited	Y5	CH5 Output enable/disable flag
X6		Y6		X6	External power off flag	Y6	CH6 Output enable/disable flag
X7		Y7		X7	Input signal error detection signal	Y7	Use prohibited
X8		Y8		X8	High resolution mode status flag	Y8	
X9		Y9		X9	Operating condition setting completion flag	Y9	Operating condition setting request
XA	YA	XA	Use prohibited	YA	Use prohibited		
XB	YB	XB		YB			
XC	YC	XC		YC			
XD	Usage disable	YD	Usage disable	XD	Maximum and minimum values reset completion flag	YD	Maximum and minimum values reset request
XE		YE		XE	A/D conversion completed flag	YE	Use prohibited
XF		YF	CH1 D/A conversion value output enable flag	XF	Error flag	YF	Error clear request
X10	CH4 digital output value	Y10	CH2 digital value setting				
X11		Y11					
X12		Y12					
X13		Y13					
X14		Y14					
X15		Y15					
X16		Y16					
X17		Y17					
X18	Y18	Usage disable					
X19	Y19						
X1A	Y1A						
X1B	Y1B	Usage disable					
X1C	Y1C						
X1D	Y1D						
X1E	Y1E	CH2 D/A conversion value output enable flag					
X1F	Y1F						

A1S66ADA			
Device No.	Signal name	Device No.	Signal name
X20	CH5 digital output value	Y20	
X21			
X22			
X23			
X24			
X25			
X26			
X27			
X28			
X29			
X2A			
X2B			
X2C			
X2D			
X2E			
X2F			
X30	CH6 digital output value	Y30	Usage disable
X31			
X32			
X33			
X34			
X35			
X36			
X37			
X38			
X39			
X3A			
X3B			
X3C			
X3D			
X3E			
X3F			

4.3.4 Buffer memory address comparison

The A1S66ADA sends and receives data to and from the CPU module through I/O signals, while the Q64AD2DA sends and receives data to and from the CPU module through buffer memory. Accordingly, the sequence program for sending and receiving data needs to be changed.

For details on the buffer memory and the sequence program, refer to Analog Input/Output Module User's Manual Q64AD2DA.

Q64AD2DA						
Address (decimal)				Name	Read/write	
CH1	CH2	CH3	CH4			
0	200	400	600	A/D conversion enable/disable setting	R/W	
1	201	401	601	Averaging process method setting	R/W	
2	202	402	602	Averaging process (time/number of times) setting	R/W	
3 to 9	203 to 209	403 to 409	603 to 609	System area	-	
10	210	410	610	A/D conversion scaling enable/disable setting	R/W	
11	211	411	611	A/D conversion scaling lower limit value	R/W	
12	212	412	612	A/D conversion scaling upper limit value	R/W	
13	213	413	613	Shifting amount to conversion value	R/W	
14 to 19	214 to 219	414 to 419	614 to 619	System area	-	
20	220	420	620	Input signal error detection setting	R/W	
21	221	421	621	Input signal error detection setting value	R/W	
22 to 29	222 to 229	422 to 429	622 to 629	System area	-	
30	230	430	630	Logging enable/disable setting	R/W	
31	231	431	631	Logging cycle setting value	R/W	
32	232	432	632	Logging cycle unit setting	R/W	
33	233	433	633	Logging data setting	R/W	
34	234	434	634	Logging points after trigger	R/W	
35	235	435	635	Level trigger condition setting	R/W	
36	236	436	636	Trigger data	R/W	
37	237	437	637	Trigger setting value	R/W	
38 to 99	238 to 299	438 to 499	638 to 699	System area	-	
100	300	500	700	Digital output value	R	
101	301	501	701	System area	-	
102	302	502	702	Scaling value	R	
103	303	503	703	System area	-	
104	304	504	704	Maximum digital output value	R	
105	305	505	705	System area	-	
106	306	506	706	Minimum digital output value	R	
107	307	507	707	System area	-	
108	308	508	708	Maximum scaling value	R	
109	309	509	709	System area	-	
110	310	510	710	Minimum scaling value	R	
111	311	511	711	System area	-	
112	312	512	712	Setting range	R	
113	313	513	713	A/D conversion completed flag	R	
114	314	514	714	Input signal error detection flag	R	
115 to 119	315 to 319	515 to 519	715 to 719	System area	-	
120	320	520	720	Oldest pointer	R	
121	321	521	721	Latest pointer	R	

Q64AD2DA							
Address (decimal)				Name			Read/write
CH1	CH2	CH3	CH4				
122	322	522	722	Logging data points			R
123	323	523	723	Trigger pointer			R
124	324	524	724	System area			-
to	to	to	to				
189	389	589	789				
190	390	590	790	Latest error code			R
191	391	591	791	Error time	First two digits of the year	Last two digits of the year	R
192	392	592	792		Month	Day	R
193	393	593	793		Hour	Minute	R
194	394	594	794		Second	Day of the week	R
195	395	595	795	System area			-
to	to	to	to				
199	399	599	799				

Q64AD2DA					
Address (decimal)		Name		Read/write	
CH5	CH6				
800	1000	D/A conversion enable/disable setting		R/W	
801	1001	System area		-	
802	1002	Digital input value		R/W	
803 to 809	1003 to 1009	System area		-	
810	1010	D/A conversion scaling enable/disable setting		R/W	
811	1011	D/A conversion scaling lower limit value		R/W	
812	1012	D/A conversion scaling upper limit value		R/W	
813	1013	Shifting amount to input value		R/W	
814 to 899	1014 to 1099	System area		-	
900	1100	Set value check code		R	
901	1101	System area		-	
902	1102	Real conversion digital value		R	
903 to 911	1103 to 1111	System area		-	
912	1112	Setting range		R	
913	1113	HOLD/CLEAR function setting		R	
914 to 989	1114 to 1189	System area		-	
990	1190	Latest error code		R	
991	1191	Error time	First two digits of the year	Last two digits of the year	R
992	1192		Month	Day	R
993	1193		Hour	Minute	R
994	1194		Second	Day of the week	R
995 to 999	1195 to 1199	System area		-	

Q64AD2DA		
Address (decimal)	Name	Read/write
1200 to 1599	System area	-
1600	Level data 0	R/W
1601	Level data 1	R/W
1602	Level data 2	R/W
1603	Level data 3	R/W
1604	Level data 4	R/W
1605	Level data 5	R/W
1606	Level data 6	R/W
1607	Level data 7	R/W
1608	Level data 8	R/W
1609	Level data 9	R/W
1610 to 1699	System area	-
1700	CH1 Digital output value	R
1701	CH2 Digital output value	R
1702	CH3 Digital output value	R
1703	CH4 Digital output value	R
1704 to 1709	System area	-
1710	CH1 Scaling value	R
1711	CH2 Scaling value	R
1712	CH3 Scaling value	R
1713	CH4 Scaling value	R
1714 to 1719	System area	-
1720	CH1 Maximum digital output value	R
1721	CH1 Minimum digital output value	R
1722	CH2 Maximum digital output value	R
1723	CH2 Minimum digital output value	R
1724	CH3 Maximum digital output value	R
1725	CH3 Minimum digital output value	R
1726	CH4 Maximum digital output value	R
1727	CH4 Minimum digital output value	R
1728 to 1739	System area	-
1740	CH1 Maximum scaling value	R
1741	CH1 Minimum scaling value	R
1742	CH2 Maximum scaling value	R
1743	CH2 Minimum scaling value	R
1744	CH3 Maximum scaling value	R
1745	CH3 Minimum scaling value	R
1746	CH4 Maximum scaling value	R
1747	CH4 Minimum scaling value	R
1748 to 1763	System area	-
1764	CH5 Set value check code	R
1765	CH6 Set value check code	R
1766 to 1773	System area	-
1774	CH5 Real conversion digital value	R
1775	CH6 Real conversion digital value	R
1776 to 1789	System area	-

Q64AD2DA			
Address (decimal)	Name		Read/write
1790	Latest error code		R
1791	Error time	First two digits of the year	
1792		Month	
1793		Hour	
1794		Second	
1795 to 1799	System area		-

Q64AD2DA					
Address (decimal)	Name			Read/write	
1800	Latest address of error history			R	
1801 to 1809	System area			-	
1810	Error code			R	
1811	History 1	Error time	First two digits of the year		Last two digits of the year
			Month		Day
			Hour		Minute
			Second		Day of the week
1812					
1813					
1814					
1815 to 1819	System area			-	
1820	Error code			R	
1821	History 2	Error time	First two digits of the year		Last two digits of the year
			Month		Day
			Hour		Minute
			Second		Day of the week
1822					
1823					
1824					
1825 to 1829	System area			-	
1830	Error code			R	
1831	History 3	Error time	First two digits of the year		Last two digits of the year
			Month		Day
			Hour		Minute
			Second		Day of the week
1832					
1833					
1834					
1835 to 1839	System area			-	
1840	Error code			R	
1841	History 4	Error time	First two digits of the year		Last two digits of the year
			Month		Day
			Hour		Minute
			Second		Day of the week
1842					
1843					
1844					
1845 to 1849	System area			-	
1850	Error code			R	
1851	History 5	Error time	First two digits of the year		Last two digits of the year
			Month		Day
			Hour		Minute
			Second		Day of the week
1852					
1853					
1854					
1855 to 1859	System area			-	

Q64AD2DA					
Address (decimal)	Name			Read/write	
1860	History 6	Error code			R
1861		Error time	First two digits of the year	Last two digits of the year	
1862			Month	Day	
1863			Hour	Minute	
1864			Second	Day of the week	
1865 to 1869	System area			-	
1870	History 7	Error code			R
1871		Error time	First two digits of the year	Last two digits of the year	
1872			Month	Day	
1873			Hour	Minute	
1874			Second	Day of the week	
1875 to 1879	System area			-	
1880	History 8	Error code			R
1881		Error time	First two digits of the year	Last two digits of the year	
1882			Month	Day	
1883			Hour	Minute	
1884			Second	Day of the week	
1885 to 1889	System area			-	
1890	History 9	Error code			R
1891		Error time	First two digits of the year	Last two digits of the year	
1892			Month	Day	
1893			Hour	Minute	
1894			Second	Day of the week	
1895 to 1899	System area			-	
1900	History 10	Error code			R
1901		Error time	First two digits of the year	Last two digits of the year	
1902			Month	Day	
1903			Hour	Minute	
1904			Second	Day of the week	
1905 to 1909	System area			-	
1910	History 11	Error code			R
1911		Error time	First two digits of the year	Last two digits of the year	
1912			Month	Day	
1913			Hour	Minute	
1914			Second	Day of the week	

Q64AD2DA					
Address (decimal)	Name			Read/write	
1915 to 1919	System area			-	
1920	History 12	Error code			R
1921		Error time	First two digits of the year	Last two digits of the year	
1922			Month	Day	
1923			Hour	Minute	
1924			Second	Day of the week	
1925 to 1929	System area			-	
1930	History 13	Error code			R
1931		Error time	First two digits of the year	Last two digits of the year	
1932			Month	Day	
1933			Hour	Minute	
1934			Second	Day of the week	
1935 to 1939	System area			-	
1940	History 14	Error code			R
1941		Error time	First two digits of the year	Last two digits of the year	
1942			Month	Day	
1943			Hour	Minute	
1944			Second	Day of the week	
1945 to 1949	System area			-	
1950	History 15	Error code			R
1951		Error time	First two digits of the year	Last two digits of the year	
1952			Month	Day	
1953			Hour	Minute	
1954			Second	Day of the week	
1955 to 1959	System area			-	
1960	History 16	Error code			R
1961		Error time	First two digits of the year	Last two digits of the year	
1962			Month	Day	
1963			Hour	Minute	
1964			Second	Day of the week	
5000 to 14999	CH1 Logging data			R	
15000 to 24999	CH2 Logging data			R	
25000 to 34999	CH3 Logging data			R	

Q64AD2DA		
Address (decimal)	Name	Read/write
35000 to 44999	CH4 Logging data	R
45000 to 49999	System area	-

5 TEMPERATURE INPUT MODULE REPLACEMENT

5.1 List of Temperature Input Module Alternative Models for Replacement

AnS/QnAS series		Transition to Q series	
Product	Model	Model	Remark (Restrictions)
Temperature input module	A1S68TD	Q64TD	1) External wiring : Cable size is changed. 2) Number of slots : Changed (Two modules are required.) 3) Program : The number of occupied I/O points, I/O signals, and buffer memory addresses are changed. 4) Performance specifications: Changed (4CH/module) 5) Functional specifications: Not changed
		Q68TD-G-H01 Q68TD-G-H02	1) External wiring : Connector wiring and cable size are changed. 2) Number of slots: : Not changed 3) Program : The number of occupied I/O points, I/O signals, and buffer memory addresses are changed. 4) Performance specifications: Not changed 5) Functional specifications: The disconnection detection function is not supported. (Only the Q68TD-G-H02 supports this function.)
	A1S62RD3N	Q64RD	1) External wiring : Cable size is changed. 2) Number of slots: : Not changed 3) Program : The number of occupied I/O points, I/O signals, and buffer memory addresses are changed. 4) Performance specifications: Changed (4CH/module) 5) Functional specifications: Not changed
		Q64RD-G	1) External wiring : Cable size is changed. 2) Number of slots: : Not changed 3) Program : The number of occupied I/O points, I/O signals, and buffer memory addresses are changed. 4) Performance specifications: Changed (4CH/module) 5) Functional specifications: Transformer isolation is provided between channels.
	A1S62RD4N	Q64RD	1) External wiring : Cable size is changed. 2) Number of slots: : Not changed 3) Program : The number of occupied I/O points, I/O signals, and buffer memory addresses are changed. 4) Performance specifications: Changed (4CH/module) 5) Functional specifications: Not changed
		Q64RD-G	1) External wiring : Cable size is changed. 2) Number of slots: : Not changed 3) Program : The number of occupied I/O points, I/O signals, and buffer memory addresses are changed. 4) Performance specifications: Changed (4CH/module) 5) Functional specifications: Transformer isolation is provided between channels.

☒ Point

The existing wiring for the AnS/QnAS series modules can be connected directly to the Q series modules using the upgrade tool (conversion adaptor) manufactured by Mitsubishi Electric Engineering Co., Ltd.

Product	MELSEC-AnS/QnAS series module	MELSEC-Q series module	Conversion adaptor
Temperature input module	A1S68TD	Q68TD-G-H01	ERNT-ASQT68TD-H01 ^{*1}
		Q68TD-G-H02	ERNT-ASQT68TD-H02 ^{*1*2}
	A1S62RD3(N)	Q64RD	ERNT-ASQT62RD
	A1S62RD4(N)		

*1 Conversion adaptor with fixture. Before using the conversion adaptor with fixture, be sure to fasten its fixture to the base adapter or DIN rail mounting bracket using screws.

*2 Cannot be mounted on the AnS size version Q large type base unit.

5.2 A1S68TD (Replacing with the Q64TD)

5.2.1 Performance specifications comparison

(1) Performance specifications comparison

Item		A1S68TD														
Temperature sensor input		0 to 1700°C														
Output	Detected temperature value	16-bit signed binary (0 to 17000: value up to the first decimal place × 10)														
	Scaling value	16-bit signed binary (0 to 2000)														
Thermocouple compliance standards		JIS C1602-1981														
Applicable thermocouple		Refer to Section 5.2.1 (2).														
Measured temperature range accuracy		Refer to Section 5.2.1 (2).														
Overall accuracy		*1														
Maximum conversion speed		400ms/8 channels														
Isolation method		<table border="1"> <thead> <tr> <th>Isolated area</th> <th>Isolation method</th> <th>Dielectric withstand voltage</th> <th>Insulation resistance</th> </tr> </thead> <tbody> <tr> <td>Between thermocouple input and programmable controller power supply</td> <td rowspan="2">Transformer isolation</td> <td rowspan="2">500VAC, for 1 minute</td> <td rowspan="2">5MΩ or more using 500VDC insulation resistance tester</td> </tr> <tr> <td>Between thermocouple input channels</td> </tr> <tr> <td>Between cold junction compensation input (Pt100) and programmable controller power supply</td> <td>Not isolated</td> <td>-</td> <td>-</td> </tr> </tbody> </table>	Isolated area	Isolation method	Dielectric withstand voltage	Insulation resistance	Between thermocouple input and programmable controller power supply	Transformer isolation	500VAC, for 1 minute	5MΩ or more using 500VDC insulation resistance tester	Between thermocouple input channels	Between cold junction compensation input (Pt100) and programmable controller power supply	Not isolated	-	-	
		Isolated area	Isolation method	Dielectric withstand voltage	Insulation resistance											
		Between thermocouple input and programmable controller power supply	Transformer isolation	500VAC, for 1 minute	5MΩ or more using 500VDC insulation resistance tester											
		Between thermocouple input channels														
Between cold junction compensation input (Pt100) and programmable controller power supply	Not isolated	-	-													
Disconnection detection		Available														
Number of temperature sensor input points		8 channels + 1 channel for Pt100/module														
Number of occupied I/O points		32 points (I/O assignment: special 32 points)														
External connection system		20-point terminal block														
Applicable wire size		0.75 to 1.5mm ²														
Applicable solderless terminal		R1.25-3, 1.25-YS3, RAV1.25-3, V1.25-YS3A														
Internal current consumption (5VDC)		0.32A														
Weight		0.28kg														

○ : Compatible, △ : Partial change required, × : Incompatible

Q64TD				Compatibility	Precautions for replacement															
-270 to 1820°C				○	The measured temperature range differs depending on the thermocouple used.															
16-bit signed binary (-2700 to 18200: value up to the first decimal place × 10)				○																
16-bit signed binary (0 to 100 (0 to 100%))				△	The concept of scaling value differs. To use the scaling values, program needs to be reviewed.															
JIS C1602-1995				△	As the applicable thermocouples and thermocouple compliance standards differ, refer to Section 5.2.1 (2) to check the specifications, and use the thermocouple that can be used with the Q64TD.															
Refer to Section 5.2.1 (2).																				
Refer to Section 5.2.1 (2).				△	As they depend on the applicable thermocouple and measured temperature range, refer to Section 5.2.1 (2) to check the specifications.															
*1				○																
40ms/channel				○																
<table border="1"> <thead> <tr> <th>Isolated area</th> <th>Isolation method</th> <th>Dielectric withstand voltage</th> <th>Insulation resistance</th> </tr> </thead> <tbody> <tr> <td>Between thermocouple input and programmable controller power supply</td> <td>Transformer isolation</td> <td rowspan="2">1780VACrms/3 cycles (Altitude 2000m)</td> <td>500VDC, 100MΩ or more</td> </tr> <tr> <td>Between thermocouple input channels</td> <td>Transformer isolation</td> <td>500VDC, 10MΩ or more</td> </tr> <tr> <td>Between cold junction compensation input (Pt100) and programmable controller power supply</td> <td>Not isolated</td> <td>-</td> <td>-</td> </tr> </tbody> </table>				Isolated area	Isolation method	Dielectric withstand voltage	Insulation resistance	Between thermocouple input and programmable controller power supply	Transformer isolation	1780VACrms/3 cycles (Altitude 2000m)	500VDC, 100MΩ or more	Between thermocouple input channels	Transformer isolation	500VDC, 10MΩ or more	Between cold junction compensation input (Pt100) and programmable controller power supply	Not isolated	-	-	○	
Isolated area	Isolation method	Dielectric withstand voltage	Insulation resistance																	
Between thermocouple input and programmable controller power supply	Transformer isolation	1780VACrms/3 cycles (Altitude 2000m)	500VDC, 100MΩ or more																	
Between thermocouple input channels	Transformer isolation		500VDC, 10MΩ or more																	
Between cold junction compensation input (Pt100) and programmable controller power supply	Not isolated	-	-																	
Available				○																
4 channels + 1 channel for Pt100/module				△	To use 5 or more channels, consider replacing the A1S68TD with two Q64TD modules.															
16 points (I/O assignment: intelligent 16 points)				△	The number of occupied I/O points has changed to 16 points.															
18-point terminal block				×	Wiring change is required.															
0.3 to 0.75mm ²				×																
1.25-3, R1.25-3 (Solderless terminals with an insulation sleeve cannot be used.)				×																
0.50A				△	Recalculation of internal current consumption (5VDC) is required.															
0.25kg				△																

*1 Calculate the accuracy in the following method.
 (Accuracy) = (Conversion accuracy) + (Temperature characteristics) × (Operating ambient temperature variation)
 + (Cold junction compensation accuracy)

An operating ambient temperature variation indicates a deviation of the operating ambient temperature from the 25±5°C range.

(2) Applicable thermocouple and measured temperature range accuracy

A1S68TD			
JIS	Measured temperature range	Conversion accuracy at 25±0.5°C	Temperature characteristics
B	800 to 1700°C	±2.5°C	±0.4°C
R	300 to 1600°C	±2°C	±0.3°C
S	300 to 1600°C	±2°C	±0.3°C
K	0 to 1200°C	Larger value of ±0.5°C, or ±0.25% of measured temperature	Larger value of ±0.07°C, or ±0.02% of measured temperature
E	0 to 800°C	Larger value of ±0.5°C, or ±0.25% of measured temperature	Larger value of ±0.07°C, or ±0.02% of measured temperature
J	0 to 750°C	Larger value of ±0.5°C, or ±0.25% of measured temperature	Larger value of ±0.07°C, or ±0.02% of measured temperature
T	0 to 350°C	Larger value of ±0.5°C, or ±0.25% of measured temperature	Larger value of ±0.07°C, or ±0.02% of measured temperature

Q64TD				
JIS	Measured temperature range*1	Conversion accuracy (At operating ambient temperature 25±5°C)	Temperature characteristics (Per operating ambient temperature variation of 1°C)	Max. temperature error at ambient temperature 55°C
B	0 to 600°C	_ *3	_ *3	_ *3
	600 to 800°C*2	±3.0°C	±0.4°C	±13.0°C
	800 to 1700°C*2	±2.5°C		±12.5°C
	1700 to 1820°C	_ *3	_ *3	_ *3
R	-50 to 0°C	_ *3	_ *3	_ *3
	0 to 300°C*2	±2.5°C	±0.4°C	±12.5°C
	300 to 1600°C*2	±2.0°C	±0.3°C	±9.5°C
	1600 to 1760°C	_ *3	_ *3	_ *3
S	-50 to 0°C	_ *3	_ *3	_ *3
	0 to 300°C*2	±2.5°C	±0.4°C	±12.5°C
	300 to 1600°C*2	±2.0°C	±0.3°C	±9.5°C
	1600 to 1760°C	_ *3	_ *3	_ *3
K	-270 to -200°C	_ *3	_ *3	_ *3
	-200 to 0°C*2	Larger value of ±0.5°C, or ±0.5% of measured temperature	Larger value of ±0.06°C, or ±0.2% of measured temperature	±11.0°C
	0 to 1200°C*2	Larger value of ±0.5°C, or ±0.25% of measured temperature	Larger value of ±0.06°C, or ±0.02% of measured temperature	±9.0°C
	1200 to 1370°C	_ *3	_ *3	_ *3
E	-270 to -200°C	_ *3	_ *3	_ *3
	-200 to 0°C*2	Larger value of ±0.5°C, or ±0.5% of measured temperature	Larger value of ±0.06°C, or ±0.15% of measured temperature	±8.5°C
	0 to 900°C*2	Larger value of ±0.5°C, or ±0.25% of measured temperature	Larger value of ±0.06°C, or ±0.02% of measured temperature	±6.75°C
	900 to 1000°C	_ *3	_ *3	_ *3
J	-210 to -40°C	_ *3	_ *3	_ *3
	-40 to 750°C*2	Larger value of ±0.5°C, or ±0.25% of measured temperature	Larger value of ±0.06°C, or ±0.02% of measured temperature	±5.625°C
	750 to 1200°C	_ *3	_ *3	_ *3
T	-270 to -200°C	_ *3	_ *3	_ *3
	-200 to 0°C*2	Larger value of ±0.5°C, or ±0.5% of measured temperature	Larger value of ±0.06°C, or ±0.1% of measured temperature	±6.0°C
	0 to 350°C*2	Larger value of ±0.5°C, or ±0.25% of measured temperature	Larger value of ±0.06°C, or ±0.02% of measured temperature	±2.625°C
	350 to 400°C	_ *3	_ *3	_ *3
N	-270 to -200°C	_ *3	_ *3	_ *3
	-200 to 0°C*2	Larger value of ±0.5°C, or ±0.5% of measured temperature	Larger value of ±0.06°C, or ±0.2% of measured temperature	±11.0°C
	0 to 1250°C*2	Larger value of ±0.5°C, or ±0.25% of measured temperature	Larger value of ±0.06°C, or ±0.02% of measured temperature	±9.375°C
	1250 to 1300°C	_ *3	_ *3	_ *3

*1 If a value entered from the thermocouple is outside the measured temperature range given in the table, it is handled as the maximum/minimum value of the measured temperature range.

*2 The accuracy only in the temperature ranges of Class 1 to 3 (shaded areas) in JIS C1602-1995 apply.

*3 Temperature can be measured, but accuracy is not guaranteed.

5.2.2 Functional comparison

○ : Available, - : Not available

Item	Description	A1S68TD	Q64TD	Precautions for replacement
Temperature conversion function (Temperature conversion value storage)	Imports temperature data. (Stores imported temperature data in the buffer memory.)	○	○	
Conversion enable/disable function	Sets whether to enable/disable a conversion per channel.	○	○	
Disconnection detection function	Detects a disconnection of the connected thermocouple of each channel.	○	○	A channel set to be conversion enabled automatically detects disconnection.
Input type selection function	Sets an input type for each channel.	○	○	For the Q64TD, input type is set with the intelligent function module switch setting of GX Developer.
Warning output function	Outputs a warning when the temperature exceeds the set temperature range.	○	○	
Temperature conversion system	Processes the detected temperature by specified method.	○	○	Averaging processing is added for the Q64TD.
Scaling function	Converts and stores a measured temperature value within the scaling range into the value between 0 to 2000.	○	△	The concept of scaling value differs. To use the scaling values, program needs to be reviewed.
Pt100 cold junction compensation enable/disable setting function	Sets whether the cold junction compensation using the Pt100 attached to the terminal is performed or not.*1	-	○	
Offset/gain setting function	Performs linear correction by individually compensating any given 2 points (offset value/gain value) within the effective range.	-	○	
Online module replacement	A module can be replaced without the system being stopped.	-	○	The Process CPU and Redundant CPU support this function.

*1 For the A1S68TD, the setting is fixed to "enabled".
 For the Q64TD, the setting can be selected. By setting "disabled" and providing an ice bath externally, the cold junction temperature compensation accuracy can be improved.

5.2.3 I/O signal comparison

Sequence program change is required as the I/O signals differ.

For details of the I/O signals and sequence program, refer to the Thermocouple Input Module/Channel Isolated Thermocouple/Micro Voltage Input Module User's Manual.

A1S68TD				Q64TD			
Device No.	Signal name	Device No.	Signal name	Device No.	Signal name	Device No.	Signal name
X0	Watchdog timer error flag	Y0	Use prohibited	X0	Module ready	Y0	Use prohibited
X1	A/D conversion READY flag	Y1		X1	CH1 Offset/gain setting status signal	Y1	CH1 Offset setting request
X2	Error flag	Y2		X2	CH2 Offset/gain setting status signal	Y2	CH1 Gain setting request
X3	Disconnection detection flag	Y3		X3	CH3 Offset/gain setting status signal	Y3	CH2 Offset setting request
X4	Out-of-measurement-range flag	Y4		X4	CH4 Offset/gain setting status signal	Y4	CH2 Gain setting request
X5	Use prohibited	Y5		X5	Use prohibited	Y5	CH3 Offset setting request
X6		Y6		X6		Y6	CH3 Gain setting request
X7		Y7		X7		Y7	CH4 Offset setting request
X8		Y8		X8		Y8	CH4 Gain setting request
X9		Y9		X9	Operating condition setting completion signal	Y9	Operating condition setting request
XA		YA		XA	Offset/gain setting mode status flag	YA	User range write request
XB		YB		XB	Use prohibited	YB	Use prohibited
XC		YC		XC	Disconnection detection flag	YC	
XD		YD		XD	Warning output signal	YD	
XE		YE		XE	Conversion completion flag	YE	
XF	YF	XF		Error flag	YF	Error clear request	
X10	Y10						
X11	Y11	Y11		Set lower/upper limit value update instruction			
X12	Y12	Y12		Error reset			
X13	Y13						
X14	Y14						
X15	Y15						
X16	Y16						
X17	Y17						
X18	Y18						
X19	Y19	Y19	Use prohibited				
X1A	Y1A						
X1B	Y1B						
X1C	Y1C						
X1D	Y1D						
X1E	Y1E						
X1F	Y1F						

5.2.4 Buffer memory address comparison

Sequence program change is required as the assignment of buffer memory differs.

For details of buffer memories and sequence programs, refer to the Thermocouple Input Module/ Channel Isolated Thermocouple/Micro Voltage Input Module User's Manual.

A1S68TD			Q64TD		
Address (decimal)	Name	Read/write	Address (decimal)	Name	Read/write
0	A/D conversion enable/disable setting	R/W	0	Conversion enable/disable setting	R/W
1	Error code	R	1	CH1 Time/count averaging setting	
2	Disconnection detection flag		2	CH2 Time/count averaging setting	
3	Out-of-measurement-range flag		3	CH3 Time/count averaging setting	
4	System area (Use prohibited)	-	4	CH4 Time/count averaging setting	-
5					
6					
7					
8					
9			9	Averaging processing specification	R/W
10	CH1 Converted temperature value (0.1°C unit)	R	10	Conversion completion flag	R
11	CH2 Converted temperature value (0.1°C unit)		11	CH1 Measured temperature value	
12	CH3 Converted temperature value (0.1°C unit)		12	CH2 Measured temperature value	
13	CH4 Converted temperature value (0.1°C unit)		13	CH3 Measured temperature value	
14	CH5 Converted temperature value (0.1°C unit)		14	CH4 Measured temperature value	
15	CH6 Converted temperature value (0.1°C unit)		15 to 18	System area (Use prohibited)	-
16	CH7 Converted temperature value (0.1°C unit)		19	Error code	R
17	CH8 Converted temperature value (0.1°C unit)		20	Setting range	
18	System area (Use prohibited)	-	21 to 46	System area (Use prohibited)	-
19			47	Warning output enable/disable setting	R/W
20	CH1 Scaling value	R	48	Warning output flag	R
21	CH2 Scaling value		49	Disconnection detection flag	
22	CH3 Scaling value		50	CH1 Scaling value	
23	CH4 Scaling value		51	CH2 Scaling value	
24	CH5 Scaling value		52	CH3 Scaling value	
25	CH6 Scaling value		53	CH4 Scaling value	
26	CH7 Scaling value		54 to 61	System area (Use prohibited)	-
27	CH8 Scaling value		62	CH1 Scaling range lower limit value	R/W
28	A/D conversion completion flag	63	CH1 Scaling range upper limit value		
29	System area (Use prohibited)	64	CH2 Scaling range lower limit value		
30	CH1 Lower limit value (0.1°C unit)	65	CH2 Scaling range upper limit value		
31	CH1 Upper limit value (0.1°C unit)	66	CH3 Scaling range lower limit value	R/W	
32	CH2 Lower limit value (0.1°C unit)	67	CH3 Scaling range upper limit value		
33	CH2 Upper limit value (0.1°C unit)	68	CH4 Scaling range lower limit value		
34	CH3 Lower limit value (0.1°C unit)	69	CH4 Scaling range upper limit value		
35	CH3 Upper limit value (0.1°C unit)	70 to 77	System area (Use prohibited)	-	
36	CH4 Lower limit value (0.1°C unit)	78	CH1 Scaling width lower limit value	R/W	
37	CH4 Upper limit value (0.1°C unit)	79	CH1 Scaling width upper limit value		
38	CH5 Lower limit value (0.1°C unit)	80	CH2 Scaling width lower limit value		
39	CH5 Upper limit value (0.1°C unit)	81	CH2 Scaling width upper limit value		
40	CH6 Lower limit value (0.1°C unit)	82	CH3 Scaling width lower limit value		
41	CH6 Upper limit value (0.1°C unit)	83	CH3 Scaling width upper limit value		
42	CH7 Lower limit value (0.1°C unit)	84	CH4 Scaling width lower limit value		
43	CH7 Upper limit value (0.1°C unit)	85	CH4 Scaling width upper limit value		
44	CH8 Lower limit value (0.1°C unit)	86	CH1 Warning output lower lower limit value	R/W	
45	CH8 Upper limit value (0.1°C unit)	87	CH1 Warning output lower upper limit value		
46	System area (Use prohibited)	88	CH1 Warning output upper lower limit value		
47		-	89		CH1 Warning output upper upper limit value

A1S68TD			Q64TD		
Address (decimal)	Name	Read/write	Address (decimal)	Name	Read/write
48	System area (Use prohibited)	-	90	CH2 Warning output lower lower limit value	R/W
49			91	CH2 Warning output lower upper limit value	
			92	CH2 Warning output upper lower limit value	
			93	CH2 Warning output upper upper limit value	
			94	CH3 Warning output lower lower limit value	
			95	CH3 Warning output lower upper limit value	
			96	CH3 Warning output upper lower limit value	
			97	CH3 Warning output upper upper limit value	
			98	CH4 Warning output lower lower limit value	
			99	CH4 Warning output lower upper limit value	
			100	CH4 Warning output upper lower limit value	
			101	CH4 Warning output upper upper limit value	
			102 to 117	System area (Use prohibited)	
			118	CH1 Offset temperature set value	R/W
			119	CH1 Gain temperature set value	
			120	CH2 Offset temperature set value	
			121	CH2 Gain temperature set value	
			122	CH3 Offset temperature set value	
			123	CH3 Gain temperature set value	
			124	CH4 Offset temperature set value	
			125	CH4 Gain temperature set value	
			126 to 147	System area (Use prohibited)	-
			148	Conversion setting for disconnection detection	R/W
			149	System area (Use prohibited)	-
			150 to 153	Conversion setting for disconnection detection (CH1 to CH4)	R/W
			154 to 157	System area (Use prohibited)	-
			158 to 159	Mode switching setting	R/W
			160	CH1 Factory default offset value	
			161	CH1 Factory default gain value	
			162	CH1 User range settings offset value	
			163	CH1 User range settings gain value	
			164	CH1 User range settings thermal EMF offset value (L)	
			165	CH1 User range settings thermal EMF offset value (H)	
			166	CH1 User range settings thermal EMF gain value (L)	
			167	CH1 User range settings thermal EMF gain value (H)	
			168	CH2 Factory default offset value	
			169	CH2 Factory default gain value	
			170	CH2 User range settings offset value	
			171	CH2 User range settings gain value	
			172	CH2 User range settings thermal EMF offset value (L)	
			173	CH2 User range settings thermal EMF offset value (H)	
			174	CH2 User range settings thermal EMF gain value (L)	
			175	CH2 User range settings thermal EMF gain value (H)	

Q64TD			
Address (decimal)	Name	Read/write	
176	CH3 Factory default offset value	R/W	
177	CH3 Factory default gain value		
178	CH3 User range settings offset value		
179	CH3 User range settings gain value		
180	CH3 User range settings thermal EMF offset value (L)		
181	CH3 User range settings thermal EMF offset value (H)		
182	CH3 User range settings thermal EMF gain value (L)		
183	CH3 User range settings thermal EMF gain value (H)		
184	CH4 Factory default offset value		
185	CH4 Factory default gain value		
186	CH4 User range settings offset value		
187	CH4 User range settings gain value		
188	CH4 User range settings thermal EMF offset value (L)		
189	CH4 User range settings thermal EMF offset value (H)		
190	CH4 User range settings thermal EMF gain value (L)		
191	CH4 User range settings thermal EMF gain value (H)		
192	System area (Use prohibited)		-
to			

Memo

5.3 A1S68TD (Replacing with the Q68TD-G-H02 or Q68TD-G-H01)

5.3.1 Performance specifications comparison

(1) Performance specifications comparison

Item		A1S68TD														
Temperature sensor input		0 to 1700°C														
Output	Detected temperature value	16-bit signed binary (0 to 17000: value up to the first decimal place × 10)														
	Scaling value	16-bit signed binary (0 to 2000)														
Thermocouple compliance standards		JIS C1602-1981														
Applicable thermocouple		Refer to Section 5.3.1 (2).														
Measured temperature range accuracy		Refer to Section 5.3.1 (2).														
Overall accuracy		*2														
Maximum conversion speed		400ms/8 channels														
Isolation method		<table border="1"> <thead> <tr> <th>Isolated area</th> <th>Isolation method</th> <th>Dielectric withstand voltage</th> <th>Insulation resistance</th> </tr> </thead> <tbody> <tr> <td>Between thermocouple input and programmable controller power supply</td> <td rowspan="2">Transformer isolation</td> <td rowspan="2">500VAC, for 1 minute</td> <td rowspan="2">5MΩ or more using 500VDC insulation resistance tester</td> </tr> <tr> <td>Between thermocouple input channels</td> </tr> <tr> <td>Between cold junction compensation input (Pt100) and programmable controller power supply</td> <td>Not isolated</td> <td>-</td> <td>-</td> </tr> </tbody> </table>	Isolated area	Isolation method	Dielectric withstand voltage	Insulation resistance	Between thermocouple input and programmable controller power supply	Transformer isolation	500VAC, for 1 minute	5MΩ or more using 500VDC insulation resistance tester	Between thermocouple input channels	Between cold junction compensation input (Pt100) and programmable controller power supply	Not isolated	-	-	
Isolated area	Isolation method	Dielectric withstand voltage	Insulation resistance													
Between thermocouple input and programmable controller power supply	Transformer isolation	500VAC, for 1 minute	5MΩ or more using 500VDC insulation resistance tester													
Between thermocouple input channels																
Between cold junction compensation input (Pt100) and programmable controller power supply	Not isolated	-	-													
Disconnection detection		Available														
Number of temperature sensor input points		8 channels + 1 channel for Pt100/module														
Number of occupied I/O points		32 points (I/O assignment: special 32 points)														
External connection system		20-point terminal block														
External device connector (sold separately)		-														
Applicable wire size		0.75 to 1.5mm ²														
Applicable solderless terminal		R1.25-3, 1.25-YS3, RAV1.25-3, V1.25-YS3A														
Internal current consumption (5VDC)		0.32A														
Weight		0.28kg														

○: Compatible, △: Partial change required, ×: Incompatible

Q series		Compatibility	Precautions for replacement															
Q68TD-G-H02	Q68TD-G-H01*1																	
-270 to 1820°C		○	The measured temperature range differs depending on the thermocouple used.															
16-bit signed binary (-2700 to 18200: value up to the first decimal place × 10)		○																
16-bit signed binary (0 to 100 (0 to 100%))		△	The concept of scaling value differs. To use the scaling values, program needs to be reviewed.															
JIS C1602-1995		△	Use the thermocouple that can be used on the Q68TD-G-H02/H01, referring to Section 5.3.1 (2).															
Refer to Section 5.3.1 (2).																		
Refer to Section 5.3.1 (2).		△	As they depend on the applicable thermocouple and measured															
*2		○	temperature range, refer to Section 5.3.1 (2) to check the specifications.															
640ms/8 channels*3	320ms/8 channels*3	○																
<table border="1"> <thead> <tr> <th>Isolated area</th> <th>Isolation method</th> <th>Dielectric withstand voltage</th> <th>Insulation resistance</th> </tr> </thead> <tbody> <tr> <td>Between thermocouple input and programmable controller power supply</td> <td>Transformer isolation</td> <td>500VACrms, for 1 minute</td> <td rowspan="2">500VDC, 10MΩ or more</td> </tr> <tr> <td>Between thermocouple input channels</td> <td>Transformer isolation</td> <td>1000VACrms, for 1 minute</td> </tr> <tr> <td>Between cold junction compensation input (Pt100) and programmable controller power supply</td> <td>Not isolated</td> <td>-</td> <td>-</td> </tr> </tbody> </table>		Isolated area	Isolation method	Dielectric withstand voltage	Insulation resistance	Between thermocouple input and programmable controller power supply	Transformer isolation	500VACrms, for 1 minute	500VDC, 10MΩ or more	Between thermocouple input channels	Transformer isolation	1000VACrms, for 1 minute	Between cold junction compensation input (Pt100) and programmable controller power supply	Not isolated	-	-	○	
Isolated area	Isolation method	Dielectric withstand voltage	Insulation resistance															
Between thermocouple input and programmable controller power supply	Transformer isolation	500VACrms, for 1 minute	500VDC, 10MΩ or more															
Between thermocouple input channels	Transformer isolation	1000VACrms, for 1 minute																
Between cold junction compensation input (Pt100) and programmable controller power supply	Not isolated	-	-															
Available (all the channels are independent)	Not available	△	The Q68TD-G-H01 supports the disconnection monitor function.															
8 channels + 1 channel for Pt100/module		○																
16 points (I/O assignment: intelligent 16 points)		△	The number of occupied I/O points has changed to 16 points.															
40-pin connector		×	Wiring change is required.															
A6CON4		×																
0.3mm ² (22 AWG) or less		×																
-		×																
0.65A	0.49A	△	Recalculation of internal current consumption (5VDC) is required.															
0.22kg	0.18kg	△																

- *1 Restrictions on mountable slot position apply to the Q68TD-G-H01.
For details, refer to the user's manual for the Q68TD-G-H01/H02.
- *2 Calculate the accuracy in the following method.
(Accuracy) = (Conversion accuracy) + (Temperature characteristics) × (Operating ambient temperature variation)
+ (Cold junction compensation accuracy)
An operating ambient temperature variation indicates a deviation of the operating ambient temperature from the 25±5°C range.
- *3 A measured temperature value is stored in the buffer memory at every 320ms/640ms, regardless of the number of conversion enable channels.

(2) Applicable thermocouple and measured temperature range accuracy

A1S68TD			
JIS	Measured temperature range	Conversion accuracy at 25±0.5°C	Temperature characteristics
B	800 to 1700	±2.5°C	±0.4°C
R	300 to 1600	±2°C	±0.3°C
S	300 to 1600	±2°C	±0.3°C
K	0 to 1200	Larger value of ±0.5°C, or ±0.25% of measured temperature	Larger value of ±0.07°C, or ±0.02% of measured temperature
E	0 to 800	Larger value of ±0.5°C, or ±0.25% of measured temperature	Larger value of ±0.07°C, or ±0.02% of measured temperature
J	0 to 750	Larger value of ±0.5°C, or ±0.25% of measured temperature	Larger value of ±0.07°C, or ±0.02% of measured temperature
T	0 to 350	Larger value of ±0.5°C, or ±0.25% of measured temperature	Larger value of ±0.07°C, or ±0.02% of measured temperature

Q68TD-G-H02, Q68TD-G-H01				
JIS	Measured temperature range ^{*1}	Conversion accuracy (At operating ambient temperature 25±5°C)	Temperature characteristics (Per operating ambient temperature variation of 1°C)	Max. temperature error at ambient temperature 55°C
B	0 to 600°C	_ *3	_ *3	_ *3
	600 to 800°C ^{*2}	±3.0°C	±0.4°C	±13.0°C
	800 to 1700°C ^{*2}	±2.5°C		±12.5°C
	1700 to 1820°C	_ *3	_ *3	_ *3
R	-50 to 0°C	_ *3	_ *3	_ *3
	0 to 300°C ^{*2}	±2.5°C	±0.4°C	±12.5°C
	300 to 1600°C ^{*2}	±2.0°C	±0.3°C	±9.5°C
	1600 to 1760°C	_ *3	_ *3	_ *3
S	-50 to 0°C	_ *3	_ *3	_ *3
	0 to 300°C ^{*2}	±2.5°C	±0.4°C	±12.5°C
	300 to 1600°C ^{*2}	±2.0°C	±0.3°C	±9.5°C
	1600 to 1760°C	_ *3	_ *3	_ *3
K	-270 to -200°C	_ *3	_ *3	_ *3
	-200 to 0°C ^{*2}	Larger value of ±0.5°C, or ±0.5% of measured temperature	Larger value of ±0.06°C, or ±0.2% of measured temperature	±11.0°C
	0 to 1200°C ^{*2}	Larger value of ±0.5°C, or ±0.25% of measured temperature	Larger value of ±0.06°C, or ±0.02% of measured temperature	±9.0°C
	1200 to 1370°C	_ *3	_ *3	_ *3
E	-270 to -200°C	_ *3	_ *3	_ *3
	-200 to 0°C ^{*2}	Larger value of ±0.5°C, or ±0.5% of measured temperature	Larger value of ±0.06°C, or ±0.15% of measured temperature	±8.5°C
	0 to 900°C ^{*2}	Larger value of ±0.5°C, or ±0.25% of measured temperature	Larger value of ±0.06°C, or ±0.02% of measured temperature	±6.75°C
	900 to 1000°C	_ *3	_ *3	_ *3
J	-210 to -40°C	_ *3	_ *3	_ *3
	-40 to 750°C ^{*2}	Larger value of ±0.5°C, or ±0.25% of measured temperature	Larger value of ±0.06°C, or ±0.02% of measured temperature	±5.625°C
	750 to 1200°C	_ *3	_ *3	_ *3
T	-270 to -200°C	_ *3	_ *3	_ *3
	-200 to 0°C ^{*2}	Larger value of ±0.5°C, or ±0.5% of measured temperature	Larger value of ±0.06°C, or ±0.1% of measured temperature	±6.0°C
	0 to 350°C ^{*2}	Larger value of ±0.5°C, or ±0.25% of measured temperature	Larger value of ±0.06°C, or ±0.02% of measured temperature	±2.625°C
	350 to 400°C	_ *3	_ *3	_ *3
N	-270 to -200°C	_ *3	_ *3	_ *3
	-200 to 0°C ^{*2}	Larger value of ±0.5°C, or ±0.5% of measured temperature	Larger value of ±0.06°C, or ±0.2% of measured temperature	±11.0°C
	0 to 1250°C ^{*2}	Larger value of ±0.5°C, or ±0.25% of measured temperature	Larger value of ±0.06°C, or ±0.02% of measured temperature	±9.375°C
	1250 to 1300°C	_ *3	_ *3	_ *3

*1 If a value entered from the thermocouple is outside the measured temperature range given in the table, it is handled as the maximum/minimum value of the measured temperature range.

*2 The accuracy only in the temperature ranges of Class 1 to 3 (shaded areas) in JIS C1602-1995 apply.

*3 Temperature can be measured, but accuracy is not guaranteed.

5.3.2 Functional comparison

○: Available, △: Partial change required, -: Not available

Item	Description	A1S68TD	Q68TD-G-H02/H01	Precautions for replacement
Temperature conversion function (Temperature conversion value storage)	Imports temperature data. (Stores imported temperature data in the buffer memory.)	○	○	
Conversion enable/disable function	Sets whether to enable/disable a conversion per channel.	○	○	
Disconnection detection function	Detects a disconnection of the connected thermocouple of each channel.	○	H02: ○ H01: △	The Q68TD-G-H01 supports the disconnection monitor function.
Input type selection function	Sets an input type for each channel.	○	○	For the Q68TD-G-H02/H01, input type is set with the intelligent function module switch setting of GX Developer.
Warning output function	Outputs a warning when the temperature exceeds the set temperature range.	○	○	
Temperature conversion system	Processes the detected temperature by specified method.	○	○	Averaging processing is added for the Q68TD-G-H02/H01.
Scaling function	Converts a measured temperature value into a percent value (%) in set width.	○	△	The concept of scaling value differs. To use the scaling values, program needs to be reviewed.
Pt100 cold junction compensation enable/disable setting function	Sets whether the cold junction compensation using the Pt100 attached to the terminal is performed or not.*1	-	○	
Offset/gain setting function	Performs linear correction by individually compensating any given 2 points (offset value/gain value) within the effective range.	-	○	
Online module replacement	A module can be replaced without the system being stopped.	-	○	The Process CPU and Redundant CPU support this function.

*1 For the A1S68TD, the setting is fixed to "enabled".
For the Q68TD-G-H02/H01, the setting can be selected. By setting "disabled" and providing an ice bath externally, the cold junction temperature compensation accuracy can be improved.

5.3.3 I/O signal comparison

Sequence program change is required as the I/O signals differ.

For details of the I/O signals and sequence program, refer to the Thermocouple Input Module/Channel Isolated Thermocouple/Micro Voltage Input Module User's Manual.

A1S68TD				Q68TD-G-H02, Q68TD-G-H01			
Device No.	Signal name	Device No.	Signal name	Device No.	Signal name	Device No.	Signal name
X0	Watchdog timer error flag	Y0	Use prohibited	X0	Module ready	Y0	Use prohibited
X1	A/D conversion READY flag	Y1		X1		Y1	
X2	Error flag	Y2		X2		Y2	
X3	Disconnection detection flag	Y3		X3		Y3	
X4	Out-of-measurement-range flag	Y4		X4	Use prohibited	Y4	
X5	Use prohibited	Y5		X5		Y5	
X6		Y6		X6		Y6	
X7		Y7		X7		Y7	
X8		Y8		X8		Y8	
X9		Y9		X9	Operating condition setting completion flag	Y9	
XA		YA	XA	Offset/gain setting mode status flag	YA	User range write request	
XB		YB	XB	Channel change completion flag	YB	Channel change request	
XC		YC	XC	Q68TD-G-H02: Disconnection detection signal Q68TD-G-H01: Disconnection status monitor signal	YC	Use prohibited	
XD		YD	XD	Warning output signal	YD		
XE		YE	XE	Conversion completion flag	YE		
XF	YF	XF	Error flag	YF	Error clear request		
X10	Y10						
X11	Y11	Y11	Set lower/upper limit value update instruction				
X12	Y12	Y12	Error reset				
X13	Y13	Use prohibited					
X14	Y14						
X15	Y15						
X16	Y16						
X17	Y17						
X18	Y18						
X19	Y19						
X1A	Y1A						
X1B	Y1B						
X1C	Y1C						
X1D	Y1D						
X1E	Y1E						
X1F	Y1F						

5.3.4 Buffer memory address comparison

Sequence program change is required as the assignment of buffer memory differs.

For details of buffer memories and sequence programs, refer to the Thermocouple Input Module/ Channel Isolated Thermocouple/Micro Voltage Input Module User's Manual.

A1S68TD			Q68TD-G-H02, Q68TD-G-H01			
Address (decimal)	Name	Read/write	Address (decimal)	Name	Read/write	
0	A/D conversion enable/disable setting	R/W	0	Conversion enable/disable setting		
1	Error code	R	1 to 8	CH1 to CH8 Time/count/moving average/time constant setting	R/W	
2	Disconnection detection flag		9	System area (Use prohibited)	-	
3	Out-of-measurement-range flag		10	Conversion completion flag		
4	System area (Use prohibited)	-	11 to 18	CH1 to CH8 Measured temperature value	R	
5			19	Error code		
6			20 to 21	CH1 to CH8 Setting range 1/2 (Thermocouple type)		
7			22	Setting range 3 (Offset/gain setting)		
8			23	System area (Use prohibited)	-	
9			24 to 25	CH1 to CH8 Averaging processing selection		
10	CH1 Converted temperature value (0.1°C unit)	R	26	Offset/gain setting mode (Offset specification)	R/W	
11	CH2 Converted temperature value (0.1°C unit)		27	Offset/gain setting mode (Gain specification)		
12	CH3 Converted temperature value (0.1°C unit)		28	CH1 Offset temperature setting value		
13	CH4 Converted temperature value (0.1°C unit)		29	CH1 Gain temperature setting value		
14	CH5 Converted temperature value (0.1°C unit)		to			
15	CH6 Converted temperature value (0.1°C unit)		43	CH8 Gain temperature setting value		
16	CH7 Converted temperature value (0.1°C unit)		44	System area (Use prohibited)		-
17	CH8 Converted temperature value (0.1°C unit)		45	Q68TD-G-H02: Cold junction compensation setting status		R
18	System area (Use prohibited)	-		Q68TD-G-H01: System area (Use prohibited)	-	
19			46	Warning output enable/disable setting	R/W	
20	CH1 Scaling value	R	47	Warning output flag (Process alarm)	R	
21	CH2 Scaling value		48	Warning output flag (Rate alarm)		
22	CH3 Scaling value		49	Q68TD-G-H02: Disconnection detection flag		
23	CH4 Scaling value			Q68TD-G-H01: Disconnection status monitor flag		
24	CH5 Scaling value		50 to 57	CH1 to CH8 Scaling value		
25	CH6 Scaling value		58	Scaling valid/invalid setting		R/W
26	CH7 Scaling value		59 to 61	System area (Use prohibited)		-
27	CH8 Scaling value		62	CH1 Scaling range lower limit value		
28	A/D conversion completion flag	63	CH1 Scaling range upper limit value			
29	System area (Use prohibited)	-	to			
30	CH1 Lower limit value (0.1°C unit)	R/W	77	CH8 Scaling range upper limit value	R/W	
31	CH1 Upper limit value (0.1°C unit)		78	CH1 Scaling width lower limit value		
32	CH2 Lower limit value (0.1°C unit)		79	CH1 Scaling width upper limit value		
33	CH2 Upper limit value (0.1°C unit)		to			
34	CH3 Lower limit value (0.1°C unit)		93	CH8 Scaling width upper limit value		
35	CH3 Upper limit value (0.1°C unit)		94	CH1 Process alarm lower lower limit value		
36	CH4 Lower limit value (0.1°C unit)		95	CH1 Process alarm lower upper limit value		
37	CH4 Upper limit value (0.1°C unit)		96	CH1 Process alarm upper lower limit value		

A1S68TD			Q68TD-G-H02, Q68TD-G-H01		
Address (decimal)	Name	Read/write	Address (decimal)	Name	Read/write
38	CH5 Lower limit value (0.1°C unit)	R/W	97	CH1 Process alarm upper upper limit value	R/W
39	CH5 Upper limit value (0.1°C unit)		to		
40	CH6 Lower limit value (0.1°C unit)		125	CH8 Process alarm upper upper limit value	
41	CH6 Upper limit value (0.1°C unit)		126 to	CH1 to CH8 Rate alarm warning detection period	
42	CH7 Lower limit value (0.1°C unit)		133		
43	CH7 Upper limit value (0.1°C unit)		134	CH1 Rate alarm upper limit value	
44	CH8 Lower limit value (0.1°C unit)		135	CH1 Rate alarm lower limit value	
45	CH8 Upper limit value (0.1°C unit)		to		
46	System area (Use prohibited)	-	149	CH8 Rate alarm lower limit value	-
47			150 to	System area (Use prohibited)	
48			157		
49			158 to	Mode switching setting	
			159		R/W
			160 to	System area (Use prohibited)	-
			163		
			164 to	Q68TD-G-H02: Conversion setting for disconnection detection	R/W
			165	Q68TD-G-H01: Disconnection state conversion setting	
			166 to	Q68TD-G-H02: Conversion setting value for disconnection detection	
			173	Q68TD-G-H01: Conversion setting value for disconnection state	
			174 to	System area (Use prohibited)	-
			189		
			190	CH1 Factory default offset value	R/W
			191	CH1 Factory default gain value	
			192	CH1 User range settings offset value	
			193	CH1 User range settings gain value	
			194	CH1 User range settings thermal EMF offset value (L)	
			195	CH1 User range settings thermal EMF offset value (H)	
			196	CH1 User range settings thermal EMF gain value (L)	
			197	CH1 User range settings thermal EMF gain value (H)	
			to		
			246	CH8 Factory default offset value	
			247	CH8 Factory default gain value	
			248	CH8 User range settings offset value	
			249	CH8 User range settings gain value	
			250	CH8 User range settings thermal EMF offset value (L)	
			251	CH8 User range settings thermal EMF offset value (H)	
			252	CH8 User range settings thermal EMF gain value (L)	
			253	CH8 User range settings thermal EMF gain value (H)	

5.4 A1S62RD3N (Replacing with the Q64RD)

5.4.1 Performance specifications comparison

Item		A1S62RD3N
Measuring method		3-wire type
Output	Temperature conversion value	16-bit signed binary: -1800 to 6000 Value up to the first decimal place × 10 32-bit signed binary: -180000 to 600000 Value up to the third decimal place × 1000
	Scaling value	-
Applicable platinum RTD		Pt100 (JIS C1604-1997, IEC 751-am2, JIS C1604-1989, DIN 43760-1980) JPt100 (JIS C1604-1981)
Measured temperature range	Pt100	-180 to 600°C (27.10 to 313.71Ω)
	JPt100	-180 to 600°C (25.80 to 317.28Ω)
Accuracy		±1% (accuracy at full scale)
Resolution		0.025°C
Conversion speed		40ms/channel
Analog input points		2 channels/module
Output current for temperature detection		1mA
Isolation method		Between platinum RTD input and programmable controller power supply: photocoupler isolation Between platinum RTD input and channel: not isolated
Dielectric withstand voltage		Between platinum RTD input and programmable controller power supply: 500VAC, for 1 minute
Disconnection detection		Detected per channel
Number of occupied I/O points		32 points (I/O assignment: special 32 points)
External connection system		20-point terminal block
Applicable wire size		0.75 to 1.5mm ²
Applicable solderless terminal		V1.25-3, V1.25-YS3A, V2-S3, V2-YS3A

○: Compatible, △: Partial change required, ×: Incompatible

	Q64RD	Compatibility	Precautions for replacement											
	3/4-wire type	○												
	16-bit signed binary: -2000 to 8500 Value up to the first decimal place × 10 32-bit signed binary: -200000 to 850000 Value up to the third decimal place × 1000	○												
	16-bit signed binary	○												
	Pt100 (JIS C 1604-1997, IEC 751 1983) JPt100 (JIS C 1604-1981)	△	As the compliance standards for the applicable platinum RTD differ, change the platinum RTD to the one that can be used with the Q64RD.											
	-200 to 850°C	○												
	-180 to 600°C													
	Ambient temperature 0 to 55°C: ±0.25% (accuracy relative to maximum value) Ambient temperature 25±5°C: ±0.08% (accuracy relative to maximum value)	○												
	0.025°C	○												
	40ms/channel	○												
	4 channels/module	○												
	1mA	○												
	<table border="1"> <thead> <tr> <th>Isolated area</th> <th>Isolation method</th> <th>Dielectric withstand voltage</th> <th>Insulation resistance</th> </tr> </thead> <tbody> <tr> <td>Between platinum RTD input and programmable controller power supply</td> <td>Photocoupler isolation</td> <td>1780VACrms/3 cycles (Altitude 2000m)</td> <td rowspan="2">10MΩ or more using 500VDC insulation resistance tester</td> </tr> <tr> <td>Between platinum RTD input channels</td> <td>Not isolated</td> <td>-</td> </tr> </tbody> </table>	Isolated area	Isolation method	Dielectric withstand voltage	Insulation resistance	Between platinum RTD input and programmable controller power supply	Photocoupler isolation	1780VACrms/3 cycles (Altitude 2000m)	10MΩ or more using 500VDC insulation resistance tester	Between platinum RTD input channels	Not isolated	-	○	
Isolated area	Isolation method	Dielectric withstand voltage	Insulation resistance											
Between platinum RTD input and programmable controller power supply	Photocoupler isolation	1780VACrms/3 cycles (Altitude 2000m)	10MΩ or more using 500VDC insulation resistance tester											
Between platinum RTD input channels	Not isolated	-												
	Detected per channel	○												
	16 points (I/O assignment: intelligent 16 points)	△	The number of occupied I/O points has changed to 16 points.											
	18-point terminal block	×	Wiring change is required.											
	0.3 to 0.75mm ²	×												
	1.25-3, R1.25-3 (Solderless terminals with an insulation sleeve cannot be used.)	×												

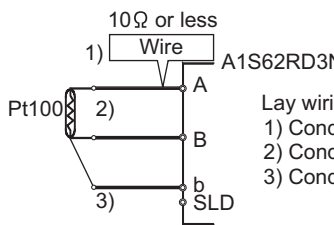
Item	A1S62RD3N	
<p>Cables between module and platinum RTD</p>	<p>Make sure that the conductor resistance value between the Pt100 and A1S62RD3N is 10Ω or less per conductor. All channels become the same specifications.</p>  <p>Lay wiring so that the following conditions are met.</p> <ol style="list-style-type: none"> 1) Conductor resistance value $\leq 10 (\Omega)$ 2) Conductor resistance value $\leq 10 (\Omega)$ 3) Conductor resistance value $\leq 10 (\Omega)$ 	
<p>Internal current consumption (5VDC)</p>	<p>0.49A</p>	
<p>Weight</p>	<p>0.27kg</p>	

○ : Compatible, △ : Partial change required, × : Incompatible

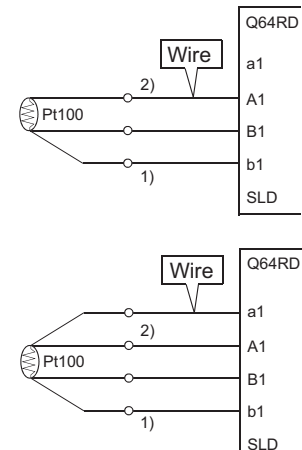
Q64RD	Compatibility	Precautions for replacement
<p>The conductor resistance value must meet the condition of $1) + 2) \leq 2k\Omega$ or less. (When a 3-wire type Pt100 is connected, the difference between 1) and 2) in the conductor resistance value must be 10Ω or less.)</p> 	○	
0.60A	△	Recalculation of internal current consumption (5VDC) is required.
0.17kg	△	

5.4.2 Functional comparison

○ : Available, - : Not available

Item	Description	A1S62RD3N	Q64RD	Precautions for replacement
Conversion enable/disable specification of each channel	Enables/disables a detection of temperature.	○	○	
Sampling/averaging processing selection	Processes the detected temperature by specified method.	○	○	The setting ranges of time and count averages differ. Check the specifications, referring to the RTD Input Module/Channel Isolated RTD Input Module User's Manual.
Detected temperature value storage	Stores temperature data in the buffer memory. (Values up to the first decimal place and the third decimal place are stored.)	○	○	
Disconnection detection	Detects a disconnection of connected platinum RTD or a cable.	○	○	The Q64RD detects disconnection per channel.
Specification of platinum RTD type	Specifies a platinum RTD type used.	○	○	
Range switching function (temperature)	Switches the measured temperature range.	-	○	
Warning output function	Outputs a warning when the temperature exceeds the set temperature range.	-	○	
Scaling function	Converts a measured temperature value into a percent value (%) in set width.	-	○	
Online module replacement	A module can be replaced without the system being stopped.	-	○	The Process CPU and Redundant CPU support this function.

5.4.3 I/O signal comparison

Sequence program change is required as the I/O signals differ.

For details of the I/O signals and sequence program, refer to the RTD Input Module/Channel Isolated RTD Input Module User's Manual.

A1S62RD3N				Q64RD			
Device No.	Signal name	Device No.	Signal name	Device No.	Signal name	Device No.	Signal name
X0	WDT error flag	Y0	Use prohibited	X0	Module ready	Y0	Use prohibited
X1	READY flag	Y1		X1	CH1 Offset/gain setting status signal	Y1	CH1 Offset setting request
X2	Write data error flag	Y2		X2	CH2 Offset/gain setting status signal	Y2	CH1 Gain setting request
X3	CH1: Disconnection-detected flag	Y3		X3	CH3 Offset/gain setting status signal	Y3	CH2 Offset setting request
X4	CH2: Disconnection-detected flag	Y4		X4	CH4 Offset/gain setting status signal	Y4	CH2 Gain setting request
X5	Use prohibited	Y5		X5	Use prohibited	Y5	CH3 Offset setting request
X6		Y6		X6		Y6	CH3 Gain setting request
X7		Y7		X7		Y7	CH4 Offset setting request
X8		Y8		X8		Y8	CH4 Gain setting request
X9		Y9		X9	Operating condition setting completion signal	Y9	Operating condition setting request
XA		YA		XA	Offset/gain setting mode status flag	YA	User range write request
XB		YB		XB	Use prohibited	YB	Use prohibited
XC		YC	XC	Disconnection detection signal	YC		
XD		YD	XD	Warning output signal	YD		
XE		YE	XE	Conversion completion flag	YE		
XF	Use prohibited	YF	XF	Error flag	YF	Error clear request	
X10	Y10						
X11	Y11						
X12	Y12		Error code reset flag				
X13	Y13						
X14	Y14						
X15	Y15						
X16	Y16						
X17	Y17						
X18	Y18						
X19	Y19		Use prohibited				
X1A	Y1A						
X1B	Y1B						
X1C	Y1C						
X1D	Y1D						
X1E	Y1E						
X1F	Y1F						

5.4.4 Buffer memory address comparison

Sequence program change is required as the assignment of buffer memory differs.

For details of the buffer memories and sequence program, refer to the RTD Input Module/Channel Isolated RTD Input Module User's Manual.

A1S62RD3N			Q64RD			
Address (decimal)	Name	Read/write	Address (decimal)	Name	Read/write	
0	Conversion enable/disable specification	R/W	0	Conversion enable/disable setting	R/W	
1	Averaging processing specification					
2	CH1 Averaging time/count					
3	CH2 Averaging time/count					
4	System area (Use prohibited)	-	4	CH4 Time/count/moving average/time constant setting	-	
5						
6						
7						
8						
9						
10	CH1 Detected temperature value (16bit)	R	10	Conversion completion flag	R	
11	CH2 Detected temperature value (16bit)					
12	System area (Use prohibited)	-	12	CH2 Measured temperature value (16bit)		
13						
14						
15						
16						
17						
18	CH1 Detected temperature value (32bit)	(L) (H)	R	18	System area (Use prohibited)	-
19						
20	CH2 Detected temperature value (32bit)	(L) (H)	R	19	Error code	R
21						
22	System area (Use prohibited)	-	22	System area (Use prohibited)	-	
23						
24						
25						
26						
27						
28						
29						
30						
31						
32						
33						
34	Write data error code	R/W	34			
35	Conversion completed flag	R	35			
36	Type specification of platinum RTD	R/W	36			
			37			
			38			
			39			
			40			
			41			
			42			
			43			
			44			

Q64RD			
Address (decimal)	Name	Read/write	
45	System area (Use prohibited)	-	
46			
47	Warning output enable/disable setting	R/W	
48	Warning output flag	R	
49	Disconnection detection flag		
50	CH1 Scaling value		
51	CH2 Scaling value		
52	CH3 Scaling value		
53	CH4 Scaling value		
54	CH1 Measured temperature value		(L)
55	(32bit)		(H)
56	CH2 Measured temperature value		(L)
57	(32bit)		(H)
58	CH3 Measured temperature value		(L)
59	(32bit)		(H)
60	CH4 Measured temperature value		(L)
61	(32bit)		(H)
62	CH1 Scaling range lower limit value		(L)
63			(H)
64	CH1 Scaling range upper limit value	(L)	
65		(H)	
66	CH2 Scaling range lower limit value	(L)	
67		(H)	
68	CH2 Scaling range upper limit value	(L)	
69		(H)	
70	CH3 Scaling range lower limit value	(L)	
71		(H)	
72	CH3 Scaling range upper limit value	(L)	
73		(H)	
74	CH4 Scaling range lower limit value	(L)	
75		(H)	
76	CH4 Scaling range upper limit value	(L)	
77		(H)	
78	CH1 Scaling width lower limit value	R/W	
79	CH1 Scaling width upper limit value		
80	CH2 Scaling width lower limit value		
81	CH2 Scaling width upper limit value		
82	CH3 Scaling width lower limit value		
83	CH3 Scaling width upper limit value		
84	CH4 Scaling width lower limit value		
85	CH4 Scaling width upper limit value		
86	CH1 Warning output lower lower limit value		(L)
87			(H)
88	CH1 Warning output lower upper limit value		(L)
89			(H)
90	CH1 Warning output upper lower limit value		(L)
91			(H)
92	CH1 Warning output upper upper limit value		(L)
93			(H)
to			
116	CH4 Warning output upper upper limit value	(L)	
117		(H)	
118	CH1 Offset temperature set value	(L)	
119		(H)	
120	CH1 Gain temperature set value	(L)	
121		(H)	

Q64RD		
Address (decimal)	Name	Read/write
to		
132	CH4 Gain temperature set value	(L)
133		(H)
134	Extended averaging processing specification	R/W
135 to 147	System area (Use prohibited)	-
148	Conversion setting for disconnection detection	R/W
149	System area (Use prohibited)	-
150	CH1 Conversion setting value for disconnection detection	(L)
151		(H)
to		
156	CH4 Conversion setting value for disconnection detection	(L)
157		(H)
158	Mode switching setting	(L)
159		(H)
160	3-wire type CH1 Factory default offset value	(L)
161		(H)
to		
254	4-wire type CH4 User range settings gain resistance value	(L)
255		(H)

5.5 A1S62RD3N (Replacing with the Q64RD-G)

5.5.1 Performance specifications comparison

Item		A1S62RD3N
Measuring method		3-wire type
Output	Temperature conversion value	16-bit signed binary: -1800 to 6000 Value up to the first decimal place × 10 32-bit signed binary: -180000 to 600000 Value up to the third decimal place × 1000
	Scaling value	-
Applicable RTD		Pt100 (JIS C1604-1997, IEC 751-am2, JIS C1604-1989, DIN 43760-1980) JPt100 (JIS C1604-1981)
Measured temperature range	Pt100	-180 to 600°C (27.10 to 313.71Ω)
	JPt100	-180 to 600°C (25.80 to 317.28Ω)
	Ni100	-
Accuracy		±1% (accuracy at full scale)
Resolution		0.025°C
Conversion speed		40ms/channel
Analog input points		2 channels/module
Output current for temperature detection		1mA
Isolation method		Between platinum RTD input and programmable controller power supply: photocoupler isolation Between platinum RTD input and channel: not isolated
Dielectric withstand voltage		Between platinum RTD input and programmable controller power supply: 500VAC, for 1 minute
Disconnection detection		Detected per channel
Number of occupied I/O points		32 points (I/O assignment: special 32 points)
External connection system		20-point terminal block
Applicable wire size		0.75 to 1.5mm ²
Applicable solderless terminal		V1.25-3, V1.25-YS3A, V2-S3, V2-YS3A

○: Compatible, △: Partial change required, ×: Incompatible

Q64RD-G		Compatibility	Precautions for replacement										
3/4-wire type		○											
16-bit signed binary: -2000 to 8500 Value up to the first decimal place × 10 32-bit signed binary: -200000 to 850000 Value up to the third decimal place × 1000		○											
16-bit signed binary		○											
Pt100 (JIS C 1604-1997, IEC751 1983) JPt100 (JIS C 1604-1981) Ni100 (DIN 43760 1987)		△	As the compliance standards for the applicable RTD differ, change the RTD to the one that can be used with the Q64RD-G.										
-200 to 850°C		○											
-180 to 600°C													
-60 to 180°C													
*1		○											
0.025°C		○											
40ms/channel		○											
4 channels/module		○											
1mA		○											
<table border="1"> <thead> <tr> <th>Isolated area</th> <th>Isolation method</th> <th>Dielectric withstand voltage</th> <th>Insulation resistance</th> </tr> </thead> <tbody> <tr> <td>Between temperature-measuring resistor input and programmable controller power supply</td> <td>Photocoupler isolation</td> <td rowspan="2">1780VACrms/3 cycles (Altitude 2000m)</td> <td rowspan="2">10MΩ or more using 500VDC insulation resistance tester</td> </tr> <tr> <td>Between temperature-measuring resistor input channels</td> <td>Transformer isolation</td> </tr> </tbody> </table>		Isolated area	Isolation method	Dielectric withstand voltage	Insulation resistance	Between temperature-measuring resistor input and programmable controller power supply	Photocoupler isolation	1780VACrms/3 cycles (Altitude 2000m)	10MΩ or more using 500VDC insulation resistance tester	Between temperature-measuring resistor input channels	Transformer isolation	○	
Isolated area	Isolation method	Dielectric withstand voltage	Insulation resistance										
Between temperature-measuring resistor input and programmable controller power supply	Photocoupler isolation	1780VACrms/3 cycles (Altitude 2000m)	10MΩ or more using 500VDC insulation resistance tester										
Between temperature-measuring resistor input channels	Transformer isolation												
Detected per channel		○											
16 points (I/O assignment: intelligent 16 points)		△	The number of occupied I/O points has changed to 16 points.										
18-point terminal block		×	Wiring change is required.										
0.3 to 0.75mm ²		×											
1.25-3, R1.25-3 (Solderless terminals with an insulation sleeve cannot be used.)		×											

*1 Accuracy (accuracy relative to the maximum value in the selection range) of the Q64RD-G is as follows.

Accuracy		Specifications
Reference accuracy		Within ±0.04%
Temperature coefficient	Pt100/JPt100 (-20 to 120°C)	±70ppm/°C (±0.0070%/°C)
	Pt100/JPt100 (0 to 200°C)	±65ppm/°C (±0.0065%/°C)
	Pt100/JPt100 (-200 to 850°C)	±50ppm/°C (±0.0050%/°C)
	Ni100 (-60 to 180°C)	±70ppm/°C (±0.0070%/°C)

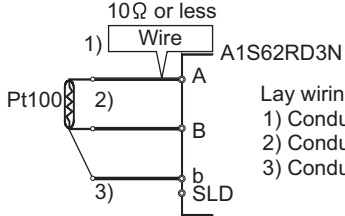
Item	A1S62RD3N	
Cable between module and RTD	<p>Make sure that the conductor resistance value between the Pt100 and A1S62RD3N is 10Ω or less per conductor. All channels become the same specifications.</p>  <p>Lay wiring so that the following conditions are met.</p> <ol style="list-style-type: none"> 1) Conductor resistance value $\leq 10 (\Omega)$ 2) Conductor resistance value $\leq 10 (\Omega)$ 3) Conductor resistance value $\leq 10 (\Omega)$ 	
Internal current consumption (5VDC)	0.49A	
Weight	0.27kg	

○: Compatible, △: Partial change required, ×: Incompatible

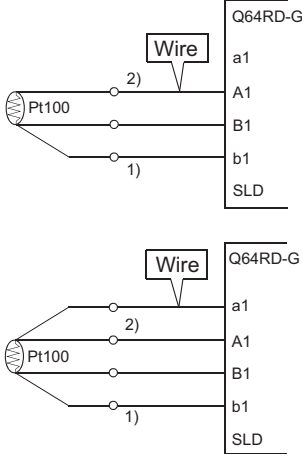
Q64RD-G	Compatibility	Precautions for replacement
<p>The conductor resistance value must meet the condition of 1) + 2) ≤ 2kΩ or less. (When a 3-wire type Pt100 is connected, the difference between 1) and 2) in the conductor resistance value must be 10Ω or less.)</p> 	○	
0.62A	△	Recalculation of internal current consumption (5VDC) is required.
0.20kg	△	

5.5.2 Functional comparison

○: Available, -: Not available

Item	Description	A1S62RD3N	Q64RD-G	Precautions for replacement
Conversion enable/disable specification of each channel	Enables/disables a detection of temperature.	○	○	
Sampling/averaging processing selection	Processes the detected temperature by specified method.	○	○	The setting ranges of time and count averages differ. Check the specifications, referring to the RTD Input Module/Channel Isolated RTD Input Module User's Manual.
Detected temperature value storage	Stores temperature data in the buffer memory.	○	○	
Disconnection detection	Detects a disconnection of the connected RTD or cable.	○	○	
Specification of RTD type	Specifies a RTD type used.	○	○	
Range switching function (temperature)	Switches the measured temperature range.	-	○	
Warning output function	Outputs a warning when the temperature exceeds the set temperature range.	-	○	
Scaling function	Converts a measured temperature value into a percent value (%) in set width.	-	○	
Online module replacement	A module can be replaced without the system being stopped.	-	○	The Process CPU and Redundant CPU support this function.

5.5.3 I/O signal comparison

Sequence program change is required as the I/O signals differ.

For details of the I/O signals and sequence program, refer to the RTD Input Module/Channel Isolated RTD Input Module User's Manual.

A1S62RD3N				Q64RD-G			
Device No.	Signal name	Device No.	Signal name	Device No.	Signal name	Device No.	Signal name
X0	WDT error flag	Y0	Use prohibited	X0	Module ready	Y0	Use prohibited
X1	READY flag	Y1		X1	CH1 Offset/gain setting status signal	Y1	CH1 Offset setting request
X2	Write data error flag	Y2		X2	CH2 Offset/gain setting status signal	Y2	CH1 Gain setting request
X3	CH1: Disconnection-detected flag	Y3		X3	CH3 Offset/gain setting status signal	Y3	CH2 Offset setting request
X4	CH2: Disconnection-detected flag	Y4		X4	CH4 Offset/gain setting status signal	Y4	CH2 Gain setting request
X5	Use prohibited	Y5		X5	Use prohibited	Y5	CH3 Offset setting request
X6		Y6		X6		Y6	CH3 Gain setting request
X7		Y7		X7		Y7	CH4 Offset setting request
X8		Y8		X8		Y8	CH4 Gain setting request
X9		Y9		X9	Operating condition setting completion signal	Y9	Operating condition setting request
XA		YA		XA	Offset/gain setting mode status flag	YA	User range write request
XB		YB		XB	Use prohibited	YB	Use prohibited
XC		YC	XC	Disconnection detection signal	YC		
XD		YD	XD	Warning output signal	YD		
XE		YE	XE	Conversion completion flag	YE		
XF		YF	XF	Error flag	YF	Error clear request	
X10		Y10					
X11	Y11						
X12	Y12		Error code reset flag				
X13	Y13						
X14	Y14						
X15	Y15						
X16	Y16						
X17	Y17						
X18	Y18						
X19	Y19		Use prohibited				
X1A	Y1A						
X1B	Y1B						
X1C	Y1C						
X1D	Y1D						
X1E	Y1E						
X1F	Y1F						

5.5.4 Buffer memory address comparison

Sequence program change is required as the assignment of buffer memory differs.
 For details of the buffer memory and sequence program, refer to the RTD Input Module/Channel Isolated RTD Input Module User's Manual.

A1S62RD3N			Q64RD-G			
Address (decimal)	Name	Read/write	Address (decimal)	Name	Read/write	
0	Conversion enable/disable specification	R/W	0	Conversion enable/disable setting	R/W	
1	Averaging processing selection		1	CH1 Time/count/moving average/time constant setting		
2	CH1 Averaging time/count		2	CH2 Time/count/moving average/time constant setting		
3	CH2 Averaging time/count		3	CH3 Time/count/moving average/time constant setting		
4	System area (Use prohibited)	-	4	CH4 Time/count/moving average/time constant setting	-	
5						
6						
7						
8						
9						
10	CH1 Detected temperature value (16bit)	R	10	Conversion completion flag	R	
11	CH2 Detected temperature value (16bit)		11	CH1 Measured temperature value (16bit)		
12	System area (Use prohibited)	-	12	CH2 Measured temperature value (16bit)		
13			13	CH3 Measured temperature value (16bit)		
14			14	CH4 Measured temperature value (16bit)		
15			15	System area (Use prohibited)	-	
16			16			
17			17			
18	CH1 Detected temperature value (32bit)	R	18	System area (Use prohibited)	-	
19	(L) (H)		19	Averaging processing specification		
20	CH2 Detected temperature value (32bit)	R	20	Conversion completion flag	R	
21	(L) (H)		21	CH1 Measured temperature value (16bit)		
22	System area (Use prohibited)	-	22	CH2 Measured temperature value (16bit)	-	
23			23	CH3 Measured temperature value (16bit)		
24			24	CH4 Measured temperature value (16bit)		
25			25	System area (Use prohibited)		-
26			26			
27			27			
28			28	System area (Use prohibited)		-
29			29			
30			30			
31			31			
32			32			
33			33			
34	Write data error code	R/W	34	System area (Use prohibited)	-	
35	Conversion completed flag	R	35	System area (Use prohibited)		
36	Type specification of platinum RTD	R/W	36	System area (Use prohibited)		
			37	System area (Use prohibited)		
			38	System area (Use prohibited)		
			39	System area (Use prohibited)		
			40	System area (Use prohibited)		
			41	System area (Use prohibited)		
			42	System area (Use prohibited)		
			43	System area (Use prohibited)		
			44	System area (Use prohibited)		

Q64RD-G			
Address (decimal)	Name	Read/write	
45	System area (Use prohibited)	-	
46			
47	Warning output enable/disable setting	R/W	
48	Warning output flag	R	
49	Disconnection detection flag		
50 to 53	CH1 to CH4 Scaling value		
54	CH1 Measured temperature value		(L)
55	(32bit)		(H)
to			
60	CH4 Measured temperature value		(L)
61	(32bit)		(H)
62	CH1 Scaling range lower limit value		(L)
63			(H)
64	CH1 Scaling range upper limit value	(L)	
65		(H)	
to			
76	CH4 Scaling range upper limit value	(L)	
77		(H)	
78	CH1 Scaling width lower limit value	R/W	
79	CH1 Scaling width upper limit value		
to			
85	CH4 Scaling width upper limit value		
86	CH1 Warning output lower lower limit value		(L)
87			(H)
88	CH1 Warning output lower upper limit value		(L)
89			(H)
90	CH1 Warning output upper lower limit value		(L)
91			(H)
92	CH1 Warning output upper upper limit value	(L)	
93		(H)	
to			
116	CH4 Warning output upper upper limit value	(L)	
117		(H)	
118	CH1 Offset temperature set value	(L)	
119		(H)	
120	CH1 Gain temperature set value	(L)	
121		(H)	
to			
132	CH4 Gain temperature set value	(L)	
133		(H)	
134	Extended averaging processing specification		
135 to 147	System area (Use prohibited)	-	
148	Conversion setting for disconnection detection	R/W	
149	System area (Use prohibited)	-	

Q64RD-G		
Address (decimal)	Name	Read/write
150	CH1 Conversion setting value for disconnection detection	(L)
151		(H)
to		
156	CH4 Conversion setting value for disconnection detection	(L)
157		(H)
158	Mode switching setting	
159		
160	3-wire type CH1 Factory default offset value	(L)
161		(H)
162	3-wire type CH1 Factory default gain value	(L)
163		(H)
164	3-wire type CH1 User range settings offset value	(L)
165		(H)
166	3-wire type CH1 User range settings gain value	(L)
167		(H)
168	3-wire type CH1 User range settings offset resistance value	(L)
169		(H)
170	3-wire type CH1 User range settings gain resistance value	(L)
171		(H)
172	4-wire type CH1 Factory default offset value	(L)
173		(H)
174	4-wire type CH1 Factory default gain value	(L)
175		(H)
176	4-wire type CH1 User range settings offset value	(L)
177		(H)
178	4-wire type CH1 User range settings gain value	(L)
179		(H)
180	4-wire type CH1 User range settings offset resistance value	(L)
181		(H)
182	4-wire type CH1 User range settings gain resistance value	(L)
183		(H)
to		
254	4-wire type CH4 User range settings gain resistance value	(L)
255		(H)

R/W

5.6 A1S62RD4N (Replacing with the Q64RD)

5.6.1 Performance specifications comparison

Item		A1S62RD4N
Measuring method		4-wire type
Output	Temperature conversion value	16-bit signed binary: -1800 to 6000 Value up to the first decimal place × 10 32-bit signed binary: -180000 to 600000 Value up to the third decimal place × 1000
	Scaling value	-
Applicable platinum RTD		Pt100 (JIS C1604-1997, IEC 751-am2, JIS C1604-1989, DIN 43760-1980) JPt100 (JIS C1604-1981)
Measured temperature range	Pt100	-180 to 600°C (27.10 to 313.71Ω)
	JPt100	-180 to 600°C (25.80 to 317.28Ω)
Accuracy		±1% (accuracy at full scale)
Resolution		0.025°C
Conversion speed		40ms/channel
Analog input points		2 channels/module
Output current for temperature detection		1mA
Isolation method		Between platinum RTD input and programmable controller power supply: photocoupler isolation Between platinum RTD input and channel: not isolated
Dielectric withstand voltage		Between platinum RTD input and programmable controller power supply: 500VAC, for 1 minute
Disconnection detection		Batch-detected at all channels.
Number of occupied I/O points		32 points (I/O assignment: special 32 points)
External connection system		20-point terminal block
Applicable wire size		0.75 to 1.5mm ²
Applicable solderless terminal		V1.25-3, V1.25-YS3A, V2-S3, V2-YS3A

○: Compatible, △: Partial change required, ×: Incompatible

	Q64RD	Compatibility	Precautions for replacement											
	3/4-wire type	○												
	16-bit signed binary: -2000 to 8500 Value up to the first decimal place × 10 32-bit signed binary: -200000 to 850000 Value up to the third decimal place × 1000	○												
	16-bit signed binary	○												
	Pt100 (JIS C 1604-1997, IEC751 1983) JPt100 (JIS C 1604-1981)	△	As the compliance standards for the applicable platinum RTD differ, change the platinum RTD to the one that can be used with the Q64RD.											
	-200 to 850°C	○												
	-180 to 600°C													
	Ambient temperature 0 to 55°C: ±0.25% (accuracy relative to maximum value) Ambient temperature 25±5°C: ±0.08% (accuracy relative to maximum value)	○												
	0.025°C	○												
	40ms/channel	○												
	4 channels/module	○												
	1mA	○												
	<table border="1"> <thead> <tr> <th>Isolated area</th> <th>Isolation method</th> <th>Dielectric withstand voltage</th> <th>Insulation resistance</th> </tr> </thead> <tbody> <tr> <td>Between platinum RTD input and programmable controller power supply</td> <td>Photocoupler isolation</td> <td>1780VACrms/3 cycles (Altitude 2000m)</td> <td rowspan="2">10MΩ or more using 500VDC insulation resistance tester</td> </tr> <tr> <td>Between platinum RTD input channels</td> <td>Not isolated</td> <td>-</td> </tr> </tbody> </table>	Isolated area	Isolation method	Dielectric withstand voltage	Insulation resistance	Between platinum RTD input and programmable controller power supply	Photocoupler isolation	1780VACrms/3 cycles (Altitude 2000m)	10MΩ or more using 500VDC insulation resistance tester	Between platinum RTD input channels	Not isolated	-	○	
Isolated area	Isolation method	Dielectric withstand voltage	Insulation resistance											
Between platinum RTD input and programmable controller power supply	Photocoupler isolation	1780VACrms/3 cycles (Altitude 2000m)	10MΩ or more using 500VDC insulation resistance tester											
Between platinum RTD input channels	Not isolated	-												
	Detected per channel	○												
	16 points (I/O assignment: intelligent 16 points)	△	The number of occupied I/O points has changed to 16 points. Wiring change is required.											
	18-point terminal block	×												
	0.3 to 0.75mm ² 1.25-3, R1.25-3 (Solderless terminals with an insulation sleeve cannot be used.)	×												

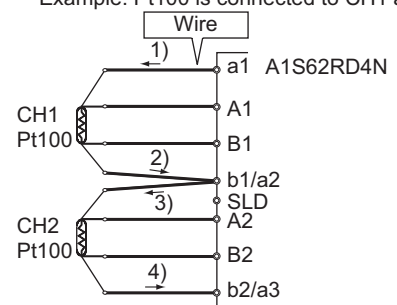
Item	A1S62RD4N	
Cable between module and platinum RTD	<p>Set the total resistance value of a conductor where the current runs to 70Ω or less.</p> <p>Example: Pt100 is connected to CH1 and CH2</p>  <p>Lay wiring so that the following condition is met. $1) + 2) + 3) + 4) \leq 70 (\Omega)$</p> <p>← indicates the direction of current.</p>	
Internal current consumption (5VDC)	0.39A	
Weight	0.27kg	

○: Compatible, △: Partial change required, ×: Incompatible

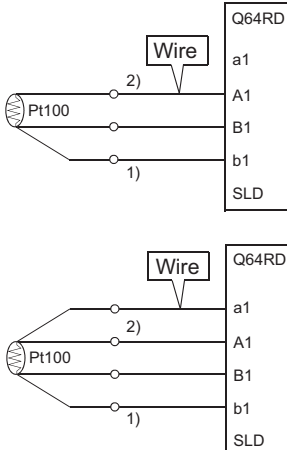
Q64RD	Compatibility	Precautions for replacement
<p>The conductor resistance value must meet the condition of $1) + 2) \leq 2k\Omega$ or less. (When a 3-wire type Pt100 is connected, the difference between 1) and 2) in the conductor resistance value must be 10Ω or less.)</p> 	○	
0.60A	△	Recalculation of internal current consumption (5VDC) is required.
0.17kg	△	

5.6.2 Functional comparison

○: Available, -: Not available

Item	Description	A1S62RD4N	Q64RD	Precautions for replacement
Conversion enable/disable specification of each channel	Enables/disables a detection of temperature.	○	○	
Sampling/averaging processing selection	Processes the detected temperature by specified method.	○	○	The setting ranges of time and count averages differ. Check the specifications, referring to the RTD Input Module/Channel Isolated RTD Input Module User's Manual.
Detected temperature value storage	Stores temperature data in the buffer memory.	○	○	
Disconnection detection	This function detects connected platinum RTD or cable breakage.	○	○	For the Q64RD, a disconnection is detected per channel.
Specification of platinum RTD type	Specifies a platinum RTD type used.	○	○	
Range switching function	Switches the measured temperature range.	-	○	
Warning output function	Outputs a warning when the temperature exceeds the set temperature range.	-	○	
Scaling function	Converts a measured temperature value into a percent value (%) in set width.	-	○	
Online module replacement	A module can be replaced without the system being stopped.	-	○	The Process CPU and Redundant CPU support this function.

5.6.3 I/O signal comparison

Sequence program change is required as the I/O signals differ.

For details of the I/O signals and sequence program, refer to the RTD Input Module/Channel Isolated RTD Input Module User's Manual.

A1S62RD4N				Q64RD			
Device No.	Signal name	Device No.	Signal name	Device No.	Signal name	Device No.	Signal name
X0	WDT error flag	Y0	Use prohibited	X0	Module ready	Y0	Use prohibited
X1	READY flag	Y1		X1	CH1 Offset/gain setting status signal	Y1	CH1 Offset setting request
X2	Write data error flag	Y2		X2	CH2 Offset/gain setting status signal	Y2	CH1 Gain setting request
X3	Σ disconnection-detected flag (CH1 and CH2)	Y3		X3	CH3 Offset/gain setting status signal	Y3	CH2 Offset setting request
X4	Use prohibited	Y4		X4	CH4 Offset/gain setting status signal	Y4	CH2 Gain setting request
X5		Y5		X5	Use prohibited	Y5	CH3 Offset setting request
X6		Y6		X6		Y6	CH3 Gain setting request
X7		Y7		X7		Y7	CH4 Offset setting request
X8		Y8		X8		Y8	CH4 Gain setting request
X9		Y9		X9	Operating condition setting completion signal	Y9	Operating condition setting request
XA		YA		XA	Offset/gain setting mode status flag	YA	User range write request
XB		YB		XB	Use prohibited	YB	Use prohibited
XC		YC	XC	Disconnection detection signal	YC		
XD		YD	XD	Warning output signal	YD		
XE	YE	XE	Conversion completion flag	YE			
XF	YF	XF	Error flag	YF	Error clear request		
X10	Y10						
X11	Y11						
X12	Y12		Error code reset flag				
X13	Y13						
X14	Y14						
X15	Y15						
X16	Y16						
X17	Y17						
X18	Y18						
X19	Y19		Use prohibited				
X1A	Y1A						
X1B	Y1B						
X1C	Y1C						
X1D	Y1D						
X1E	Y1E						
X1F	Y1F						

5.6.4 Buffer memory address comparison

Sequence program change is required as the assignment of buffer memory differs.

For details of the buffer memory and sequence program, refer to the RTD Input Module/Channel Isolated RTD Input Module User's Manual.

A1S62RD4N			Q64RD		
Address (decimal)	Name	Read/write	Address (decimal)	Name	Read/write
0	Conversion enable/disable specification	R/W	0	Conversion enable/disable setting	R/W
1	Averaging processing specification				
2	CH1 Averaging time/count				
3	CH2 Averaging time/count				
4	System area (Use prohibited)	-	4	CH4 Time/count/moving average/time constant setting	-
5					
6					
7					
8					
9					
10	CH1 Detected temperature value (16bit)	R	10	Conversion completion flag	R
11	CH2 Detected temperature value (16bit)				
12	System area (Use prohibited)	-	12	CH2 Measured temperature value (16bit)	
13					
14					
15					
16					
17					
18	CH1 Detected temperature value (32bit)	R	18	System area (Use prohibited)	-
19	(L) (H)				
20	CH2 Detected temperature value (32bit)	R	19	Error code	R
21	(L) (H)				
22	System area (Use prohibited)	-	20	Setting range	-
23					
24					
25					
26					
27					
28					
29					
30					
31					
32					
33					
34	Write data error code	R/W	34	System area (Use prohibited)	-
35	Conversion completed flag	R	35		
36	Type specification of platinum RTD	R/W	36		
			37		
			38		
			39		
			40		
			41		
			42		
			43		
			44		

Q64RD			
Address (decimal)	Name	Read/write	
45	System area (Use prohibited)	-	
46			
47	Warning output enable/disable setting	R/W	
48	Warning output flag	R	
49	Disconnection detection flag		
50	CH1 Scaling value		
51	CH2 Scaling value		
52	CH3 Scaling value		
53	CH4 Scaling value		
54	CH1 Measured temperature value		(L)
55	(32bit)		(H)
56	CH2 Measured temperature value		(L)
57	(32bit)		(H)
58	CH3 Measured temperature value		(L)
59	(32bit)		(H)
60	CH4 Measured temperature value		(L)
61	(32bit)		(H)
62	CH1 Scaling range lower limit value	(L)	
63		(H)	
64	CH1 Scaling range upper limit value	(L)	
65		(H)	
66	CH2 Scaling range lower limit value	(L)	
67		(H)	
68	CH2 Scaling range upper limit value	(L)	
69		(H)	
70	CH3 Scaling range lower limit value	(L)	
71		(H)	
72	CH3 Scaling range upper limit value	(L)	
73		(H)	
74	CH4 Scaling range lower limit value	(L)	
75		(H)	
76	CH4 Scaling range upper limit value	(L)	
77		(H)	
78	CH1 Scaling width lower limit value	R/W	
79	CH1 Scaling width upper limit value		
80	CH2 Scaling width lower limit value		
81	CH2 Scaling width upper limit value		
82	CH3 Scaling width lower limit value		
83	CH3 Scaling width upper limit value		
84	CH4 Scaling width lower limit value		
85	CH4 Scaling width upper limit value		
86	CH1 Warning output lower lower limit value		(L)
87			(H)
88	CH1 Warning output lower upper limit value		(L)
89			(H)
90	CH1 Warning output upper lower limit value		(L)
91			(H)
92	CH1 Warning output upper upper limit value	(L)	
93		(H)	
to			
116	CH4 Warning output upper upper limit value	(L)	
117		(H)	
118	CH1 Offset temperature set value	(L)	
119		(H)	
120	CH1 Gain temperature set value	(L)	
121		(H)	

Q64RD		
Address (decimal)	Name	Read/write
to		
132	CH4 Gain temperature	(L)
133		(H)
134	Extended averaging processing specification	R/W
135 to 147	System area (Use prohibited)	
148	Conversion setting for disconnection detection	R/W
149	System area (Use prohibited)	-
150	CH1 Conversion setting value for disconnection detection	(L)
151		(H)
to		
156	CH4 Conversion setting value for disconnection detection	(L)
157		(H)
158	Mode switching setting	R/W
159		
160	3-wire type CH1 Factory default offset value	(L)
161		(H)
to		
254	4-wire type CH4 User range settings gain resistance value	(L)
255		(H)

Memo

5.7 A1S62RD4N (Replacing with the Q64RD-G)

5.7.1 Performance specifications comparison

Item		A1S62RD4N
Measuring method		4-wire type
Output	Temperature conversion value	16-bit signed binary: -1800 to 6000 Value up to the first decimal place × 10 32-bit signed binary: -180000 to 600000 Value up to the third decimal place × 1000
	Scaling value	-
Applicable RTD		Pt100 (JIS C1604-1997, IEC 751-am2, JIS C1604-1989, DIN 43760-1980) JPt100 (JIS C1604-1981)
Measured temperature range	Pt100	-180 to 600°C (27.10 to 313.71Ω)
	JPt100	-180 to 600°C (25.80 to 317.28Ω)
	Ni100	-
Accuracy		±1% (accuracy at full scale)
Resolution		0.025°C
Conversion speed		40ms/channel
Analog input points		2 channels/module
Output current for temperature detection		1mA
Isolation method		Between platinum RTD input and programmable controller power supply: photocoupler isolation Between platinum RTD input and channel: not isolated
Dielectric withstand voltage		Between platinum RTD input and programmable controller power supply: 500VAC, for 1 minute
Disconnection detection		Batch-detected at all channels.
Number of occupied I/O points		32 points (I/O assignment: special 32 points)
External connection system		20-point terminal block
Applicable wire size		0.75 to 1.5mm ²
Applicable solderless terminal		V1.25-3, V1.25-YS3A, V2-S3, V2-YS3A

○: Compatible, △: Partial change required, ×: Incompatible

Q64RD-G		Compatibility	Precautions for replacement										
3/4-wire type		○											
16-bit signed binary : -2000 to 8500 Value up to the first decimal place × 10 32-bit signed binary: -200000 to 850000 Value up to the third decimal place × 1000		○											
16-bit signed binary		○											
Pt100 (JIS C 1604-1997, IEC751 1983) JPt100 (JIS C 1604-1981) Ni100 (DIN 43760 1987)		△	As the compliance standards for the applicable RTD differ, change the RTD to the one that can be used with the Q64RD-G.										
-200 to 850°C		○											
-180 to 600°C													
-60 to 180°C													
*1		○											
0.025°C		○											
40ms/channel		○											
4 channels/module		○											
1mA		○											
<table border="1"> <thead> <tr> <th>Isolated area</th> <th>Isolation method</th> <th>Dielectric withstand voltage</th> <th>Insulation resistance</th> </tr> </thead> <tbody> <tr> <td>Between temperature-measuring resistor input and programmable controller power supply</td> <td>Photocoupler isolation</td> <td rowspan="2">1780VACrms/3 cycles (Altitude 2000m)</td> <td rowspan="2">10MΩ or more using 500VDC insulation resistance tester</td> </tr> <tr> <td>Between temperature-measuring resistor input channels</td> <td>Transformer isolation</td> </tr> </tbody> </table>		Isolated area	Isolation method	Dielectric withstand voltage	Insulation resistance	Between temperature-measuring resistor input and programmable controller power supply	Photocoupler isolation	1780VACrms/3 cycles (Altitude 2000m)	10MΩ or more using 500VDC insulation resistance tester	Between temperature-measuring resistor input channels	Transformer isolation	○	
Isolated area	Isolation method	Dielectric withstand voltage	Insulation resistance										
Between temperature-measuring resistor input and programmable controller power supply	Photocoupler isolation	1780VACrms/3 cycles (Altitude 2000m)	10MΩ or more using 500VDC insulation resistance tester										
Between temperature-measuring resistor input channels	Transformer isolation												
Detected per channel		○											
16 points (I/O assignment: intelligent 16 points)		△	The number of occupied I/O points has changed to 16 points. Wiring change is required.										
18-point terminal block		×											
0.3 to 0.75mm ² 1.25-3, R1.25-3 (Solderless terminals with an insulation sleeve cannot be used.)		×											

*1 Accuracy (accuracy relative to the maximum value in the selection range) of the Q64RD-G is as follows.

Accuracy		Specifications
Reference accuracy		Within ±0.04%
Temperature coefficient	Pt100/JPt100 (-20 to 120°C)	±70ppm/°C (±0.0070%/°C)
	Pt100/JPt100 (0 to 200°C)	±65ppm/°C (±0.0065%/°C)
	Pt100/JPt100 (-200 to 850°C)	±50ppm/°C (±0.0050%/°C)
	Ni100 (-60 to 180°C)	±70ppm/°C (±0.0070%/°C)

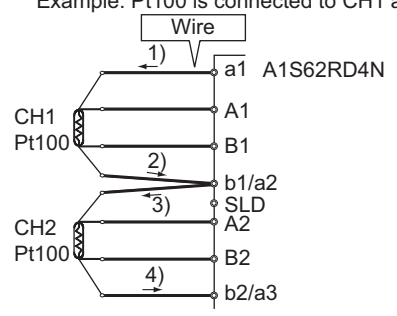
Item	A1S62RD4N	
Cable across module - platinum resistance thermometer	<p>Set the total resistance value of a conductor where the current runs to 70Ω or less.</p> <p>Example: Pt100 is connected to CH1 and CH2</p>  <p>Lay wiring so that the following condition is met. $1) + 2) + 3) + 4) \leq 70 (\Omega)$</p> <p>← indicates the direction of current.</p>	
Internal current consumption (5VDC)	0.39A	
Weight	0.27kg	

○: Compatible, △: Partial change required, ×: Incompatible

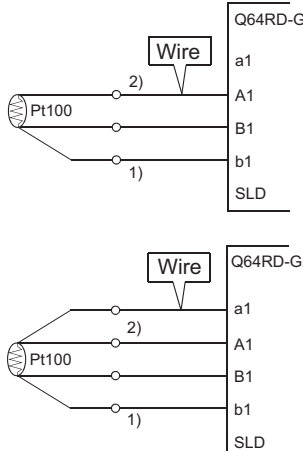
Q64RD-G	Compatibility	Precautions for replacement
<p>The conductor resistance value must meet the condition of $1) + 2) \leq 2k\Omega$ or less. (When a 3-wire type Pt100 is connected, the difference between 1) and 2) in the conductor resistance value must be 10Ω or less.)</p> 	○	
0.62A	△	Recalculation of internal current consumption (5VDC) is required.
0.20kg	△	

5.7.2 Functional comparison

○: Available, -: Not available

Item	Description	A1S62RD4N	Q64RD-G	Precautions for replacement
Conversion enable/disable specification of each channel	Enables/disables a detection of temperature.	○	○	
Sampling/averaging processing selection	Processes the detected temperature by specified method.	○	○	The setting ranges of time and count averages differ. Check the specifications, referring to the RTD Input Module/Channel Isolated RTD Input Module User's Manual.
Detected temperature value storage	Stores temperature data in the buffer memory.	○	○	
Disconnection detection	Detects a disconnection of the connected RTD or cable.	○	○	For the Q64RD-G, a disconnection is detected per channel.
Type specification of RTD	Specifies a RTD type used.	○	○	
Range switching function	Switches the measured temperature range.	-	○	
Warning output function	Outputs a warning when the temperature exceeds the set temperature range.	-	○	
Scaling function	Converts a measured temperature value into a percent value (%) in set width.	-	○	
Online module replacement	A module can be replaced without the system being stopped.	-	○	The Process CPU and Redundant CPU support this function.

5.7.3 I/O signal comparison

Sequence program change is required as the I/O signals differ.

For details of the I/O signals and sequence program, refer to the RTD Input Module/Channel Isolated RTD Input Module User's Manual.

A1S62RD4N				Q64RD-G			
Device No.	Signal name	Device No.	Signal name	Device No.	Signal name	Device No.	Signal name
X0	WDT error flag	Y0	Use prohibited	X0	Module ready	Y0	Use prohibited
X1	READY flag	Y1		X1	CH1 Offset/gain setting status signal	Y1	CH1 Offset setting request
X2	Write data error flag	Y2		X2	CH2 Offset/gain setting status signal	Y2	CH1 Gain setting request
X3	Σ disconnection-detected flag (CH1 and CH2)	Y3		X3	CH3 Offset/gain setting status signal	Y3	CH2 Offset setting request
X4	Use prohibited	Y4		X4	CH4 Offset/gain setting status signal	Y4	CH2 Gain setting request
X5		Y5		X5	Use prohibited	Y5	CH3 Offset setting request
X6		Y6		X6		Y6	CH3 Gain setting request
X7		Y7		X7		Y7	CH4 Offset setting request
X8		Y8		X8		Y8	CH4 Gain setting request
X9		Y9		X9	Operating condition setting completion signal	Y9	Operating condition setting request
XA		YA		XA	Offset/gain setting mode status flag	YA	User range write request
XB		YB		XB	Use prohibited	YB	Use prohibited
XC		YC	XC	Disconnection detection signal	YC		
XD		YD	XD	Warning output signal	YD		
XE	YE	XE	Conversion completion flag	YE			
XF	YF	XF	Error flag	YF	Error clear request		
X10	Y10						
X11	Y11						
X12	Y12		Error code reset flag				
X13	Y13						
X14	Y14						
X15	Y15						
X16	Y16						
X17	Y17						
X18	Y18						
X19	Y19		Use prohibited				
X1A	Y1A						
X1B	Y1B						
X1C	Y1C						
X1D	Y1D						
X1E	Y1E						
X1F	Y1F						

5.7.4 Buffer memory address comparison

Sequence program change is required as the assignment of buffer memory differs.

For details of the buffer memory and sequence program, refer to the RTD Input Module/Channel Isolated RTD Input Module User's Manual.

A1S62RD4N			Q64RD-G			
Address (decimal)	Name	Read/write	Address (decimal)	Name	Read/write	
0	Conversion enable/disable specification	R/W	0	Conversion enable/disable setting	R/W	
1	Averaging processing specification					
2	CH1 Averaging time/count					
3	CH2 Averaging time/count					
4	System area (Use prohibited)	-	4	CH4 Time/count/moving average/time constant setting	-	
5						
6						
7						
8						
9						
10	CH1 Detected temperature value (16bit)	R	10	Conversion completion flag	R	
11	CH2 Detected temperature value (16bit)					
12	System area (Use prohibited)	-	12	CH2 Measured temperature value (16bit)		
13						
14						
15						
16						
17						
18	CH1 Detected temperature value (32bit)	(L) (H)	R	18	System area (Use prohibited)	-
19						
20	CH2 Detected temperature value (32bit)	(L) (H)	R	20	Error code	R
21						
22	System area (Use prohibited)	-	22	System area (Use prohibited)	-	
23						
24						
25						
26						
27						
28						
29						
30						
31						
32						
33						
34	Write data error code	R/W	34			
35	Conversion completed flag	R	35			
36	Type specification of platinum RTD	R/W	36			
			37			
			38			

Q64RD-G			
Address (decimal)	Name	Read/write	
39	System area (Use prohibited)	-	
40			
41			
42			
43			
44			
45			
46			
47	Warning output enable/disable setting	R/W	
48	Warning output flag	R	
49	Disconnection detection flag		
50 to 53	CH1 to CH4 Scaling value		
54	CH1 Measured temperature value		(L)
55	(32bit)		(H)
to			
60	CH4 Measured temperature value		(L)
61	(32bit)		(H)
62	CH1 Scaling range lower limit value		(L)
63			(H)
64	CH1 Scaling range upper limit value	(L)	
65		(H)	
to			
76	CH4 Scaling range upper limit value	(L)	
77		(H)	
78	CH1 Scaling width lower limit value	R/W	
79	CH1 Scaling width upper limit value		
to			
85	CH4 Scaling width upper limit value		
86	CH1 Warning output lower lower limit value		(L)
87			(H)
88	CH1 Warning output lower upper limit value		(L)
89			(H)
90	CH1 Warning output upper lower limit value		(L)
91			(H)
92	CH1 Warning output upper upper limit value	(L)	
93		(H)	
to			
116	CH4 Warning output upper upper limit value	(L)	
117		(H)	
118	CH1 Offset temperature set value	(L)	
119		(H)	
120	CH1 Gain temperature set value	(L)	
121		(H)	
to			
132	CH4 Gain temperature set value	(L)	
133		(H)	
134	Extended averaging processing specification		
135 to 147	System area (Use prohibited)	-	
148	Conversion setting for disconnection detection	R/W	
149	System area (Use prohibited)	-	
150	CH1 Conversion setting value for disconnection detection	(L)	
151		(H)	

Q64RD-G		
Address (decimal)	Name	Read/write
to		
156	CH4 Conversion setting value for	(L)
157	disconnection detection	(H)
158	Mode switching setting	
159		
160	3-wire type CH1 Factory default offset	(L)
161	value	(H)
162	3-wire type CH1 Factory default gain	(L)
163	value	(H)
164	3-wire type CH1 User range settings	(L)
165	offset value	(H)
166	3-wire type CH1 User range settings	(L)
167	gain value	(H)
168	3-wire type CH1 User range settings	(L)
169	offset resistance value	(H)
170	3-wire type CH1 User range settings	(L)
171	gain resistance value	(H)
172	4-wire type CH1 Factory default offset	(L)
173	value	(H)
174	4-wire type CH1 Factory default gain	(L)
175	value	(H)
176	4-wire type CH1 User range settings	(L)
177	offset value	(H)
178	4-wire type CH1 User range settings	(L)
179	gain value	(H)
180	4-wire type CH1 User range settings	(L)
181	offset resistance value	(H)
182	4-wire type CH1 User range settings	(L)
183	gain resistance value	(H)
to		
254	4-wire type CH4 User range settings	(L)
255	gain resistance value	(H)

R/W

6

HEATING-COOLING TEMPERATURE CONTROL MODULE/TEMPERATURE CONTROL MODULE REPLACEMENT

6.1 List of Heating-cooling Temperature Control Module/Temperature Control Module Alternative Models for Replacement

AnS/QnAS series		Transition to Q series	
Product	Model	Model	Remark (Restrictions)
Heating-cooling temperature control module Temperature control module	A1S64TCTRT Thermocouple, standard control	Q64TCTTN	1) External wiring : Cable size is changed. 2) Number of slots : Not changed 3) Program : The number of occupied I/O points, I/O signals, and buffer memory addresses are changed. 4) Performance specifications: Not changed 5) Functional specifications: Changed (Refer to Section 6.3.)
	A1S64TCTRT Thermocouple, heating-cooling control	Q64TCTTN	1) External wiring : Cable size is changed. 2) Number of slots : Not changed 3) Program : The number of occupied I/O points, I/O signals, and buffer memory addresses are changed. 4) Performance specifications: Not changed 5) Functional specifications: Changed (Refer to Section 6.3.)
	A1S64TCTRT Platinum resistance thermometer, standard control	Q64TCRTN	1) External wiring : Cable size is changed. 2) Number of slots : Not changed 3) Program : The number of occupied I/O points, I/O signals, and buffer memory addresses are changed. 4) Performance specifications: Not changed 5) Functional specifications: Changed (Refer to Section 6.3.)
	A1S64TCTRT Platinum resistance thermometer, heating-cooling control	Q64TCRTN	1) External wiring : Cable size is changed. 2) Number of slots : Not changed 3) Program : The number of occupied I/O points, I/O signals, and buffer memory addresses are changed. 4) Performance specifications: Not changed 5) Functional specifications: Changed (Refer to Section 6.3.)
	A1S64TCTRTBW Thermocouple, standard control	Q64TCTTBWN	1) External wiring : Cable size is changed. 2) Number of slots : Changed (2 slots are required. I/O assignment: 16 empty points for the first half, 16 intelligent points for the second half) 3) Program : The number of occupied I/O points, I/O signals, and buffer memory addresses are changed. 4) Performance specifications: Not changed 5) Functional specifications: Changed (Refer to Section 6.3.)
	A1S64TCTRTBW Thermocouple, heating-cooling control	Q64TCTTBWN	1) External wiring : Cable size is changed. 2) Number of slots : Changed (2 slots are required. I/O assignment: 16 empty points for the first half, 16 intelligent points for the second half) 3) Program : The number of occupied I/O points, I/O signals, and buffer memory addresses are changed. 4) Performance specifications: Not changed 5) Functional specifications: Changed (Refer to Section 6.3.)

AnS/QnAS series		Transition to Q series	
Product	Model	Model	Remark (Restrictions)
Heating-cooling temperature control module Temperature control module	A1S64TCRTBW Platinum resistance thermometer, standard control	Q64TCRTBWN	1) External wiring : Cable size is changed. 2) Number of slots : Changed (2 slots are required. I/O assignment: 16 empty points for the first half, 16 intelligent points for the second half) 3) Program : The number of occupied I/O points, I/O signals, and buffer memory addresses are changed. 4) Performance specifications: Not changed 5) Functional specifications: Changed (Refer to Section 6.3.)
	A1S64TCRTBW Platinum resistance thermometer, heating-cooling control	Q64TCRTBWN	1) External wiring : Cable size is changed. 2) Number of slots : Changed (2 slots are required. I/O assignment: 16 empty points for the first half, 16 intelligent points for the second half) 3) Program : The number of occupied I/O points, I/O signals, and buffer memory addresses are changed. 4) Performance specifications: Not changed 5) Functional specifications: Changed (Refer to Section 6.3.)
	A1S64TCTT-S1 Thermocouple, standard control	Q64TCTTN	1) External wiring : Cable size is changed. 2) Number of slots : Not changed 3) Program : The number of occupied I/O points, I/O signals, and buffer memory addresses are changed. 4) Performance specifications: Not changed 5) Functional specifications: Changed (Refer to Section 6.3.)
	A1S64TCTTBW-S1 Thermocouple, standard control	Q64TCTTBWN	1) External wiring : Cable size is changed. 2) Number of slots : Changed (2 slots are required. I/O assignment: 16 empty points for the first half, 16 intelligent points for the second half) 3) Program : The number of occupied I/O points, I/O signals, and buffer memory addresses are changed. 4) Performance specifications: Not changed 5) Functional specifications: Changed (Refer to Section 6.3.)
	A1S64TCRT-S1 Platinum resistance thermometer, standard control	Q64TCRTN	1) External wiring : Cable size is changed. 2) Number of slots : Not changed 3) Program : The number of occupied I/O points, I/O signals, and buffer memory addresses are changed. 4) Performance specifications: Not changed 5) Functional specifications: Changed (Refer to Section 6.3.)
	A1S64TCRTBW-S1 Platinum resistance thermometer, standard control	Q64TCRTBWN	1) External wiring : Cable size is changed. 2) Number of slots : Changed (2 slots are required. I/O assignment: 16 empty points for the first half, 16 intelligent points for the second half) 3) Program : The number of occupied I/O points, I/O signals, and buffer memory addresses are changed. 4) Performance specifications: Not changed 5) Functional specifications: Changed (Refer to Section 6.3.)
	A1S62TCTT-S2 Thermocouple, heating-cooling control	Q64TCTTN	1) External wiring : Cable size is changed. 2) Number of slots : Not changed 3) Program : The number of occupied I/O points, I/O signals, and buffer memory addresses are changed. 4) Performance specifications: Changed (2CH/module → 4CH/module) 5) Functional specifications: Changed (Refer to Section 6.3.)
	A1S62TCTTBW-S2 Thermocouple, heating-cooling control	Q64TCTTBWN	1) External wiring : Cable size is changed. 2) Number of slots : Changed (2 slots are required. I/O assignment: 16 empty points for the first half, 16 intelligent points for the second half) 3) Program : The number of occupied I/O points, I/O signals, and buffer memory addresses are changed. 4) Performance specifications: Changed (2CH/module → 4CH/module) 5) Functional specifications: Changed (Refer to Section 6.3.)

AnS/QnAS series		Transition to Q series	
Product	Model	Model	Remark (Restrictions)
Heating-cooling temperature control module Temperature control module	A1S62TCRT-S2 Platinum resistance thermometer, heating-cooling control	Q64TCRTN	1) External wiring : Cable size is changed. 2) Number of slots : Not changed 3) Program : The number of occupied I/O points, I/O signals, and buffer memory addresses are changed. 4) Performance specifications: Changed (2CH/module → 4CH/module) 5) Functional specifications: Changed (Refer to Section 6.3.)
	A1S62TCRTBW-S2 Platinum resistance thermometer, heating-cooling control	Q64TCRTBWN	1) External wiring : Cable size is changed. 2) Number of slots : Changed (2 slots are required. I/O assignment: 16 empty points for the first half, 16 intelligent points for the second half) 3) Program : The number of occupied I/O points, I/O signals, and buffer memory addresses are changed. 4) Performance specifications: Changed (2CH/module → 4CH/module) 5) Functional specifications: Changed (Refer to Section 6.3.)

☒ Point

The existing wiring for the AnS/QnAS series modules can be connected directly to the Q series modules using the upgrade tool (conversion adaptor) manufactured by Mitsubishi Electric Engineering Co., Ltd.

(1) One slot type (can be mounted on the Q large type base unit)

Product	MELSEC-AnS/QnAS series module	MELSEC-Q series module	Conversion adaptor
Temperature control module	A1S64TCTT-S1	Q64TCTTN	ERNT-ASQT64TCTT
	A1S64TCTRT* ¹		
	A1S64TCRT-S1	Q64TCRTN	ERNT-ASQT64TCRT
	A1S64TCTRT* ²		
	A1S62TCTT-S2	Q64TCTTN	ERNT-ASQT62TCTT
	A1S64TCTRT* ³		
	A1S62TCRT-S2	Q64TCRTN	ERNT-ASQT62TCRT
	A1S64TCTRT* ⁴		

- *1 With the standard control and thermocouple input used
- *2 With the standard control and platinum resistance thermometer input used
- *3 With the heating-cooling control and thermocouple input used
- *4 With the heating-cooling control and platinum resistance thermometer input used

(2) Two slot type

(cannot be mounted on the Q large type base unit or AnS size version Q large type base unit)

Product	MELSEC-AnS/QnAS series module	MELSEC-Q series module	Conversion adaptor* ¹
Disconnection detection function-equipped temperature control module	A1S64TCTTBW-S1	Q64TCTTBWN	ERNT-ASQT64TCTTBW
	A1S64TCTRTBW* ²		
	A1S64TCRTBW-S1	Q64TCRTBWN	ERNT-ASQT64TCRTBW
	A1S64TCTRTBW* ³		
	A1S62TCTTBW-S2	Q64TCTTBWN	ERNT-ASQT62TCTTBW
	A1S64TCTRTBW* ⁴		
	A1S62TCRTBW-S2	Q64TCRTBWN	ERNT-ASQT62TCRTBW
	A1S64TCTRTBW* ⁵		

- *1 These models refer to the set product consisting of an one slot type conversion adaptor "ERNT-ASQT64TC□□" and a disconnection detection connector conversion cable.
- *2 With the standard control and thermocouple input used
- *3 With the standard control and platinum resistance thermometer input used
- *4 With the heating-cooling control and thermocouple input used
- *5 With the heating-cooling control and platinum resistance thermometer input used

6.2 Performance Specifications Comparison

6.2.1 A1S64TCTRT(BW) (thermocouple connection)

Item		Specifications		
		A1S64TCTRT	A1S64TCTRTBW	
Control output		Transistor output		
Number of temperature input points		Standard control: 4 channels/module Heating-cooling control: 2 channels/module		
Applicable temperature sensor		(Refer to Section 6.2.1 (1).)		
Accuracy	Indication accuracy		(Ambient temperature: 25±5°C) Full scale × (±0.3%) ± 1 digit	
			(Ambient temperature: 0 to 55°C) Full scale × (±0.7%) ± 1 digit	
	Cold junction temperature compensation accuracy: (ambient temperature: 0 to 55°C)	Temperature process value (PV): -100°C or more	Within ±1.0°C	
		Temperature process value (PV): -150 to -100°C	Within ±2.0°C	
Temperature process value (PV): -200 to -150°C		Within ±3.0°C		
Sampling cycle		0.5s (Constant regardless of the number of channels used)		
Control output cycle		1 to 100s		
Input impedance		1MΩ		
Input filter		0 to 100s		
Sensor correction value setting		-50.00 to 50.00%		
Operation at sensor input disconnection		Upscale processing		
Temperature control method		Standard control: PID ON/OFF pulse or two-position control Heating-cooling control: PID ON/OFF pulse		
PID constants range	PID constants setting		Standard control: Can be set by auto-tuning or self-tuning. Heating-cooling control: Can be set by auto-tuning.	
	Proportional band (P)		Standard control: 0.0 to 1000.0% Heating-cooling control: 0.1 to 1000.0%	
	Integral time (I)		1 to 3600s	
	Derivative time (D)		0 to 3600s	
Set value (SV) setting range		Within the temperature range set for the temperature sensor to be used		
Transistor output	Output signal		ON/OFF pulse	
	Rated load voltage		10.2 to 30VDC (peak voltage 30.0V)	
	Max. load current		0.1A/point, 0.4A/common	
	Max. inrush current		0.4A, 10ms	
	Leakage current at OFF		0.1mA or less	
	Max. voltage drop at ON		1.0VDC (TYP) at 0.1A 2.5VDC (MAX) at 0.1A	
	Response time		OFF→ON: 2ms or less, ON→OFF: 2ms or less	
Number of writes to E ² PROM		Max. 10 ¹² times (number of FeRAM read/write)		

○: Compatible, △: Partial change required, ×: Incompatible

	Specifications		Compatibility	Precautions for replacement
	Q64TCTTN	Q64TCTBWN		
	Transistor output		○	
	Standard control: 4 channels/module Heating-cooling control: 2 channels/module		○	
	(Refer to Section 6.2.1 (1).)		○	
	(Ambient temperature: 25±5°C) Full scale × (±0.3%)* ¹		○	
	(Ambient temperature: 0 to 55°C) Full scale × (±0.7%)* ¹			
	Within ±1.0°C* ¹		○	
	Within ±2.0°C* ¹			
	Within ±3.0°C* ¹			
	0.5s (Constant regardless of the number of channels used)		○	
	1 to 100s		○	
	1MΩ		○	
	0 to 100s		○	
	-50.00 to 50.00%		○	
	Upscale processing		○	
	PID ON/OFF pulse or two-position control		○	
	Standard control: Can be set by auto-tuning or self-tuning. Heating-cooling control: Can be set by auto-tuning.		○	
	0.0 to 1000.0%		○	
	0 to 3600s		○	
	0 to 3600s		○	
	Within the temperature range set for the temperature sensor to be used		○	
	ON/OFF pulse		○	
	10 to 30VDC		○	
	0.1A/point, 0.4A/common		○	
	0.4A, 10ms		○	
	0.1mA or less		○	
	1.0VDC (TYP) at 0.1A 2.5VDC (MAX) at 0.1A		○	
	OFF→ON: 2ms or less, ON→OFF: 2ms or less		○	
	Max. 10 ¹² times (number of read/write from/to a non-volatile memory)		○	

*1 Calculate the accuracy in the following method (only when it is not affected by noise).
Accuracy (°C) = full scale × indication accuracy + cold junction temperature compensation accuracy
(Example) Accuracy at the input range of 38 (-200.0 to 400.0°C), the operating ambient temperature of 35°C, and the temperature process value (PV) of 300°C
(Full scale) × (indication accuracy) + cold junction temperature compensation accuracy
= (400.0°C - (-200.0°C)) × (±0.007) + (±1.0°C)
= ±5.2°C

Item	Specifications	
	A1S64TCTRT	A1S64TCTRTBW
Insulation method	Between input terminal and programmable controller power supply: Transformer insulation Between input channels: Transformer insulation	
Dielectric withstand voltage	Between input terminal and programmable controller power supply: 500VAC, for 1 minute Between input channels: 500VAC, for 1 minute	
Insulation resistance	Between input terminal and programmable controller power supply: 500VDC, 10MΩ or more Between input channels: 500VDC, 10MΩ or more	
Heater disconnection detection specifications	Current sensor	U.R.D.Co., LTD. CTL-12-S36-8 CTL-6-P(-H)
	Input accuracy	Full scale × (±1.0%)
	Number of alert delay	3 to 255
Number of occupied I/O points	32 points (I/O assignment: special 32 points)	
Connection terminal	20-point terminal block	
Applicable wire size	0.75 to 1.5mm ²	
Applicable solderless terminal	R1.25-3, 1.25-YS3, RAV1.25-3, V1.25-YS3A	
Internal current consumption	0.33A (0.19A) ^{*2}	0.39A (0.25A) ^{*2}
Weight	0.26kg	0.28kg
External dimensions	34.5(W) × 130(H) × 93.6(D)mm	

*2 Current value when the temperature conversion function is not used in an unused channel under heating-cooling control.

(1) List of thermocouple type, temperature measurement range, and resolution

Thermocouple type	°C		°F			
	Temperature measurement range	Resolution	Temperature measurement range	Resolution		
R	0 to 1700	1	0 to 3000	1		
K	0 to 500	1	0 to 1000	1		
	0 to 800		0 to 2400			
	0 to 1300					
	-200.0 to 400.0					
J	0.0 to 400.0	0.1	0.0 to 1000.0	0.1		
	0.0 to 500.0					
	0.0 to 800.0					
	0 to 500		1		0 to 1000	1
	0 to 800				0 to 1600	
	0 to 1200				0 to 2100	
T	0.0 to 400.0	1	0.0 to 1000.0	0.1		
	0.0 to 500.0					
	0.0 to 800.0					
	-200 to 400		1		0 to 700	1
	-200 to 200				-300 to 400	
	0 to 200					
	-200.0 to 400.0	0.1	0.0 to 700.0	0.1		
	0.0 to 400.0					

(To the next page)

○: Compatible, △: Partial change required, ×: Incompatible

Specifications		Compatibility	Precautions for replacement
Q64TCTTN	Q64TCTTBWN		
Between input terminal and programmable controller power supply: Transformer insulation Between input channels: Transformer insulation		○	
Between input terminal and programmable controller power supply: 500VAC, for 1 minute Between input channels: 500VAC, for 1 minute		○	
Between input terminal and programmable controller power supply: 500VDC, 20MΩ or more Between input channels: 500VDC, 20MΩ or more		○	
	U.R.D.Co., LTD. CTL-12-S36-8 CTL-12-S36-10 CTL-12-S56-10 CTL-6-P(-H)	○	
	Full scale × (±1.0%)		
	3 to 255		
16 points/slot (I/O assignment: intelligent 16 points)	32 points/2 slots (default I/O assignment Vacancy for 16 points + intelligent 16 points)	△	The number of occupied I/O points and slots are different.
18-point terminal block	Two 18-point terminal blocks	×	Wiring change is required.
22 to 18 AWG			
R1.25-3			
0.29A	0.33A	△	Recalculation of internal current consumption (5VDC) is required.
0.17kg	0.28kg	△	
27.4(W) × 98(H) × 112(D)mm	55.2(W) × 98(H) × 112(D)mm	-	

(From the previous page)

Thermocouple type	°C		°F	
	Temperature measurement range	Resolution	Temperature measurement range	Resolution
S	0 to 1700	1	0 to 3000	1
B	400 to 1800	1	800 to 3000	1
E	0 to 400	1	0 to 1800	1
	0 to 1000			
N	0.0 to 700.0	0.1	-	-
	0 to 1300	1	0 to 2300	1
U	0 to 400	1	0 to 700	1
	-200 to 200		-300 to 400	
L	0.0 to 600.0	0.1	-	-
	0 to 400	1	0 to 800	1
	0 to 900		0 to 1600	
PLII	0.0 to 400.0	0.1	-	-
	0.0 to 900.0			
PLII	0 to 1200	1	0 to 2300	1
W5Re/W26Re	0 to 2300	1	0 to 3000	1

6.2.2 A1S64TCTRT(BW) (platinum resistance thermometer connection)

Item		Specifications	
		A1S64TCTRT	A1S64TCTRTBW
Control output		Transistor output	
Number of temperature input points		Standard control: 4 channels/module Heating-cooling control: 2 channels/module	
Applicable temperature sensor		(Refer to Section 6.2.2 (1).)	
Indication accuracy		(Ambient temperature: 25±5°C) Full scale × (±0.3%) ± 1 digit	
		(Ambient temperature: 0 to 55°C) Full scale × (±0.7%) ± 1 digit	
Sampling cycle		0.5s (Constant regardless of the number of channels used)	
Control output cycle		1 to 100s	
Input impedance		1MΩ	
Input filter		0 to 100s	
Sensor correction value setting		-50.00 to 50.00%	
Operation at sensor input disconnection		Upscale processing	
Temperature control method		Standard control: PID ON/OFF pulse or two-position control Heating-cooling control: PID ON/OFF pulse	
PID constants range	PID constants setting	Standard control: Can be set by auto-tuning or self-tuning. Heating-cooling control: Can be set by auto-tuning.	
	Proportional band (P)	Standard control: 0.0 to 1000.0% Heating-cooling control: 0.1 to 1000.0%	
	Integral time (I)	1 to 3600s	
	Derivative time (D)	0 to 3600s	
Set value (SV) setting range		Within the temperature range set for the temperature sensor to be used	
Transistor output	Output signal	ON/OFF pulse	
	Rated load voltage	10.2 to 30VDC (peak voltage 30.0V)	
	Max. load current	0.1A/point, 0.4A/common	
	Max. inrush current	0.4A, 10ms	
	Leakage current at OFF	0.1mA or less	
	Max. voltage drop at ON	1.0VDC (TYP) at 0.1A 2.5VDC (MAX) at 0.1A	
	Response time	OFF → ON: 2ms or less, ON → OFF: 2ms or less	
Number of writes to E ² PROM		Max. 10 ¹² times (number of FeRAM read/write)	

○: Compatible, △: Partial change required, ×: Incompatible

	Specifications		Compatibility	Precautions for replacement
	Q64TCRTN	Q64TCRTBWN		
	Transistor output		○	
	Standard control: 4 channels/module Heating-cooling control: 2 channels/module		○	
	(Refer to Section 6.2.2 (1).)		○	
	(Ambient temperature: 25±5°C) Full scale × (±0.3%)* ¹		○	
	(Ambient temperature: 0 to 55°C) Full scale × (±0.7%)* ¹			
	0.5s (Constant regardless of the number of channels used)		○	
	1 to 100s		○	
	1MΩ		○	
	0 to 100s		○	
	-50.00 to 50.00%		○	
	Upscale processing		○	
	PID ON/OFF pulse or two-position control		○	
	Standard control: Can be set by auto-tuning or self-tuning. Heating-cooling control: Can be set by auto-tuning.		○	
	0.0 to 1000.0%		○	
	0 to 3600s		○	
	0 to 3600s		○	
	Within the temperature range set for the temperature sensor to be used		○	
	ON/OFF pulse		○	
	10 to 30VDC		○	
	0.1A/point, 0.4A/common		○	
	0.4A 10ms		○	
	0.1mA or less		○	
	1.0VDC (TYP) at 0.1A 2.5VDC (MAX) at 0.1A		○	
	OFF→ON: 2ms or less, ON→OFF: 2ms or less		○	
	Max. 10 ¹² times (number of read/write from/to a non-volatile memory)		○	

*1 Calculate the accuracy in the following method (only when it is not affected by noise).
Accuracy (°C) = full scale × indication accuracy + cold junction temperature compensation accuracy

(Example) Accuracy at the input range of 38 (-200.0 to 400.0°C), the operating ambient temperature of 35°C, and the temperature process value (PV) of 300°C

(Full scale) × (indication accuracy) + cold junction temperature compensation accuracy
= (400.0°C - (-200.0°C)) × (±0.007) + (±1.0°C)
= ±5.2°C

Item	Specifications	
	A1S64TCTRT	A1S64TCTRTBW
Insulation method	Between input terminal and programmable controller power supply: Transformer insulation Between input channels: Transformer insulation	
Dielectric withstand voltage	Between input terminal and programmable controller power supply: 500VAC, for 1 minute Between input channels: 500VAC, for 1 minute	
Insulation resistance	Between input terminal and programmable controller power supply: 500VDC, 10MΩ or more Between input channels: 500VDC, 10MΩ or more	
Heater disconnection detection specifications	Current sensor	U.R.D.Co., LTD. CTL-12-S36-8 CTL-6-P(-H)
	Input accuracy	Full scale × (±1.0%)
	Number of alert delay	3 to 255
Number of occupied I/O points	32 points (I/O assignment: special 32 points)	
Connection terminal	20-point terminal block	
Applicable wire size	0.75 to 1.5mm ²	
Applicable solderless terminal	R1.25-3, 1.25-YS3, RAV1.25-3, V1.25-YS3A	
Internal current consumption	0.33A (0.19A)* ²	0.39A (0.25A)* ²
Weight	0.26kg	0.28kg
External dimensions	34.5(W) × 130(H) × 93.6(D)mm	

*2 Current value when the temperature conversion function is not used in an unused channel under heating-cooling control.

(1) List of usable platinum resistance thermometer, temperature measurement range, and resolution

Platinum resistance thermometer type	°C		°F	
	Temperature measurement range	Resolution	Temperature measurement range	Resolution
Pt100	-200.0 to 600.0	0.1	-300 to 1100	1
	-200.0 to 200.0		-300.0 to 300.0	0.1
JPt100	-200.0 to 500.0	0.1	-300 to 900	1
	-200.0 to 200.0		-300.0 to 300.0	0.1

○: Compatible, △: Partial change required, ×: Incompatible

Specifications		Compatibility	Precautions for replacement
Q64TCRTN	Q64TCRTBWN		
Between input terminal and programmable controller power supply: Transformer insulation Between input channels: Transformer insulation		○	
Between input terminal and programmable controller power supply: 500VAC, for 1 minute Between input channels: 500VAC, for 1 minute		○	
Between input terminal and programmable controller power supply: 500VDC, 20MΩ or more Between input channels: 500VDC, 20MΩ or more		○	
	U.R.D.Co., LTD. CTL-12-S36-8 CTL-12-S36-10 CTL-12-S56-10 CTL-6-P(-H)	○	
	Full scale × (±1.0%)		
	3 to 255		
16 points/slot (I/O assignment: intelligent 16 points)	32 points/2 slots (default I/O assignment Vacancy for 16 points + intelligent 16 points)	△	The number of occupied I/O points and slots are different.
18-point terminal block	Two 18-point terminal blocks	×	Wiring change is required.
22 to 18 AWG			
R1.25-3			
0.29A	0.33A	△	Recalculation of internal current consumption (5VDC) is required.
0.17kg	0.28kg	△	
27.4(W) × 98(H) × 112(D)mm	55.2(W) × 98(H) × 112(D)mm	-	

6.2.3 A1S64TCTT(BW)-S1

Item		Specifications		
		A1S64TCTT-S1	A1S64TCTTBW-S1	
Control output		Transistor output		
Number of temperature input points		4 channels/module		
Applicable temperature sensor		(Refer to Section 6.2.3 (1).)		
Accuracy	Indication accuracy		(Ambient temperature: 25±5°C) Full scale × (±0.3%) ± 1 digit	
			(Ambient temperature: 0 to 55°C) Full scale × (±0.7%) ± 1 digit	
	Cold junction temperature compensation accuracy: (ambient temperature: 0 to 55°C)	Temperature process value (PV): -100°C or more	Within ±1.0°C	
		Temperature process value (PV): -150 to -100°C	Within ±2.0°C	
Temperature process value (PV): -200 to -150°C		Within ±3.0°C		
Sampling cycle		0.5s (Constant regardless of the number of channels used)		
Control output cycle		1 to 100s		
Input impedance		1MΩ		
Input filter		0 to 100s		
Sensor correction value setting		-50.00 to 50.00%		
Operation at sensor input disconnection		Upscale processing		
Temperature control method		PID ON/OFF pulse or two-position control		
PID constants range	PID constants setting		Can be set by auto-tuning.	
	Proportional band (P)		0.0 to 1000.0%	
	Integral time (I)		1 to 3600s	
	Derivative time (D)		0 to 3600s	
Set value (SV) setting range		Within the temperature range set for the temperature sensor to be used		
Transistor output	Output signal		ON/OFF pulse	
	Rated load voltage		10.2 to 30VDC	
	Max. load current		0.1A/point, 0.4A/common	
	Max. inrush current		0.4A, 10ms	
	Leakage current at OFF		0.1mA or less	
	Max. voltage drop at ON		1.0VDC (TYP) at 0.1A 2.5VDC (MAX) at 0.1A	
	Response time		OFF → ON: 2ms or less, ON → OFF: 2ms or less	
Number of writes to E ² PROM		Max. 100,000 times		

○: Compatible, △: Partial change required, ×: Incompatible

	Specifications		Compatibility	Precautions for replacement
	Q64TCTTN	Q64TCTBWN		
	Transistor output		○	
	4 channels/module		○	
	(Refer to Section 6.2.3 (1).)		○	
	(Ambient temperature: 25±5°C) Full scale × (±0.3%)* ¹		○	
	(Ambient temperature: 0 to 55°C) Full scale × (±0.7%)* ¹			
	Within ±1.0°C* ¹		○	
	Within ±2.0°C* ¹			
	Within ±3.0°C* ¹			
	0.5s (Constant regardless of the number of channels used)		○	
	1 to 100s		○	
	1MΩ		○	
	0 to 100s		○	
	-50.00 to 50.00%		○	
	Upscale processing		○	
	PID ON/OFF pulse or two-position control		○	
	Can be set by auto-tuning or self-tuning.		○	
	0.0 to 1000.0%		○	
	0 to 3600s		○	
	0 to 3600s		○	
	Within the temperature range set for the temperature sensor to be used		○	
	ON/OFF pulse		○	
	10 to 30VDC		○	
	0.1A/point, 0.4A/common		○	
	0.4A, 10ms		○	
	0.1mA or less		○	
	1.0VDC (TYP) at 0.1A 2.5VDC (MAX) at 0.1A		○	
	OFF → ON: 2ms or less, ON → OFF: 2ms or less		○	
	Max. 10 ¹² times (number of read/write from/to a non-volatile memory)		○	

*1 Calculate the accuracy in the following method (only when it is not affected by noise).
Accuracy (°C) = full scale × indication accuracy + cold junction temperature compensation accuracy

(Example) Accuracy at the input range of 38 (-200.0 to 400.0°C), the operating ambient temperature of 35°C, and the temperature process value (PV) of 300°C

$$\begin{aligned} & (\text{Full scale}) \times (\text{indication accuracy}) + \text{cold junction temperature compensation accuracy} \\ & = (400.0^\circ\text{C} - (-200.0^\circ\text{C})) \times (\pm 0.007) + (\pm 1.0^\circ\text{C}) \\ & = \pm 5.2^\circ\text{C} \end{aligned}$$

Item	Specifications	
	A1S64TCTT-S1	A1S64TCTTBW-S1
Insulation method	Between input terminal and programmable controller power supply: Transformer insulation Between input channels: Transformer insulation	
Dielectric withstand voltage	Between input terminal and programmable controller power supply: 500VAC, for 1 minute Between input channels: 500VAC, for 1 minute	
Insulation resistance	Between input terminal and programmable controller power supply: 500VDC, 10MΩ or more Between input channels: 500VDC, 10MΩ or more	
Heater disconnection detection specifications	Current sensor	U.R.D.Co., LTD. CTL-12-S36-8 CTL-6-P(-H)
	Input accuracy	Full scale × (±1.0%)
	Number of alert delay	3 to 255
Number of occupied I/O points	32 points (I/O assignment: special 32 points)	
Connection terminal	20-point terminal block	
Applicable wire size	0.75 to 1.5mm ²	
Applicable solderless terminal	R1.25-3, 1.25-YS3, RAV1.25-3, V1.25-YS3A	
Internal current consumption	0.33A	0.42A
Weight	0.27kg	0.30kg
External dimensions	34.5(W) × 130(H) × 93.6(D)mm	

(1) List of thermocouple type, temperature measurement range, and resolution

Thermocouple type	°C		°F	
	Temperature measurement range	Resolution	Temperature measurement range	Resolution
R	0 to 1700	1	0 to 3000	1
K	0 to 500	1	0 to 1000	1
	0 to 800		0 to 2400	
	0 to 1300			
	-200.0 to 400.0	0.1	0.0 to 1000.0	0.1
J	0.0 to 400.0	0.1	0.0 to 1000.0	0.1
	0.0 to 500.0			
	0.0 to 800.0			
	0 to 500	1	0 to 1000	1
0 to 800	0 to 1600			
0 to 1200	0 to 2100			
T	-200 to 400	1	0 to 700	1
	-200 to 200		-300 to 400	
	0 to 200			
	0 to 400	0.1	0.0 to 700.0	0.1
	-200.0 to 400.0	0.1	0.0 to 700.0	0.1
	0.0 to 400.0			

(To the next page)

○: Compatible, △: Partial change required, ×: Incompatible

Specifications		Compatibility	Precautions for replacement
Q64TCTTN	Q64TCTTBWN		
Between input terminal and programmable controller power supply: Transformer insulation Between input channels: Transformer insulation		○	
Between input terminal and programmable controller power supply: 500VAC, for 1 minute Between input channels: 500VAC, for 1 minute		○	
Between input terminal and programmable controller power supply: 500VDC, 20MΩ or more Between input channels: 500VDC, 20MΩ or more		○	
	U.R.D.Co., LTD. CTL-12-S36-8 CTL-12-S36-10 CTL-12-S56-10 CTL-6-P(-H)	○	
	Full scale × (±1.0%)		
	3 to 255		
16 points/slot (I/O assignment: intelligent 16 points)	32 points/2 slots (default I/O assignment Vacancy for 16 points + intelligent 16 points)	△	The number of occupied I/O points and slots are different.
18-point terminal block	Two 18-point terminal blocks	×	Wiring change is required.
22 to 18 AWG			
R1.25-3			
0.29A	0.33A	△	Recalculation of internal current consumption (5VDC) is required.
0.17kg	0.28kg	△	
27.4(W) × 98(H) × 112(D)mm	55.2(W) × 98(H) × 112(D)mm	-	

(From the previous page)

Thermocouple type	°C		°F	
	Temperature measurement range	Resolution	Temperature measurement range	Resolution
S	0 to 1700	1	0 to 3000	1
B	400 to 1800	1	800 to 3000	1
E	0 to 400	1	0 to 1800	1
	0 to 1000			
N	0.0 to 700.0	0.1	-	-
	0 to 1300	1	0 to 2300	1
U	0 to 400	1	0 to 700	1
	-200 to 200		-300 to 400	
L	0.0 to 600.0	0.1	-	-
	0 to 400	1	0 to 800	1
	0 to 900		0 to 1600	
PLII	0.0 to 400.0	0.1	-	-
	0.0 to 900.0			
PLII	0 to 1200	1	0 to 2300	1
W5Re/W26Re	0 to 2300	1	0 to 3000	1

6.2.4 A1S64TCRT(BW)-S1 (platinum resistance thermometer connection)

Item	Specifications	
	A1S64TCRT-S1	A1S64TCRTBW-S1
Control output	Transistor output	
Number of temperature input points	4 channels/module	
Applicable temperature sensor	(Refer to Section 6.2.4 (1).)	
Indication accuracy	(Ambient temperature: 25±5°C) Full scale × (±0.3%) ± 1 digit	
	(Ambient temperature: 0 to 55°C) Full scale × (±0.7%) ± 1 digit	
Sampling cycle	0.5s (Constant regardless of the number of channels used)	
Control output cycle	1 to 100s	
Input impedance	1MΩ	
Input filter	0 to 100s	
Sensor correction value setting	-50.00 to 50.00%	
Operation at sensor input disconnection	Upscale processing	
Temperature control method	PID ON/OFF pulse or two-position control	
PID constants range	PID constants setting	Can be set by auto-tuning.
	Proportional band (P)	0.0 to 1000.0%
	Integral time (I)	1 to 3600s
	Derivative time (D)	0 to 3600s
Set value (SV) setting range	Within the temperature range set for the temperature sensor to be used	
Transistor output	Output signal	ON/OFF pulse
	Rated load voltage	10.2 to 30VDC
	Max. load current	0.1A/point, 0.4A/common
	Max. inrush current	0.4A, 10ms
	Leakage current at OFF	0.1mA or less
	Max. voltage drop at ON	1.0VDC (TYP) at 0.1A 2.5VDC (MAX) at 0.1A
	Response time	OFF→ON: 2ms or less, ON→OFF: 2ms or less
Number of writes to E ² PROM	Max. 100,000 times	

○: Compatible, △: Partial change required, ×: Incompatible

	Specifications		Compatibility	Precautions for replacement
	Q64TCRTN	Q64TCRTBWN		
	Transistor output		○	
	4 channels/module		○	
	(Refer to Section 6.2.4 (1).)		○	
	(Ambient temperature: 25±5°C) Full scale × (±0.3%)* ¹		○	
	(Ambient temperature: 0 to 55°C) Full scale × (±0.7%)* ¹			
	0.5s (Constant regardless of the number of channels used)		○	
	1 to 100s		○	
	1MΩ		○	
	0 to 100s		○	
	-50.00 to 50.00%		○	
	Upscale processing		○	
	PID ON/OFF pulse or two-position control		○	
	Can be set by auto-tuning or self-tuning.		○	
	0.0 to 1000.0%		○	
	0 to 3600s		○	
	0 to 3600s		○	
	Within the temperature range set for the temperature sensor to be used		○	
	ON/OFF pulse		○	
	10 to 30VDC		○	
	0.1A/point, 0.4A/common		○	
	0.4A 10ms		○	
	0.1mA or less		○	
	1.0VDC (TYP) at 0.1A		○	
	2.5VDC (MAX) at 0.1A			
	OFF→ON: 2ms or less, ON→OFF: 2ms or less		○	
	Max. 10 ¹² times (number of read/write from/to a non-volatile memory)		○	

*1 Calculate the accuracy in the following method (only when it is not affected by noise).
Accuracy (°C) = full scale × indication accuracy + cold junction temperature compensation accuracy

(Example) Accuracy at the input range of 38 (-200.0 to 400.0°C), the operating ambient temperature of 35°C, and the temperature process value (PV) of 300°C

$$\begin{aligned}
 & (\text{Full scale}) \times (\text{indication accuracy}) + \text{cold junction temperature compensation accuracy} \\
 & = (400.0^\circ\text{C} - (-200.0^\circ\text{C})) \times (\pm 0.007) + (\pm 1.0^\circ\text{C}) \\
 & = \pm 5.2^\circ\text{C}
 \end{aligned}$$

Item	Specifications	
	A1S64TCRT-S1	A1S64TCRTBW-S1
Insulation output	Between input terminal and programmable controller power supply: Transformer insulation Between input channels: Transformer insulation	
Dielectric withstand voltage	Between input terminal and programmable controller power supply: 500VAC, for 1 minute Between input channels: 500VAC, for 1 minute	
Insulation resistance	Between input terminal and programmable controller power supply: 500VDC, 10MΩ or more Between input channels: 500VDC, 10MΩ or more	
Heater disconnection detection specifications	Current sensor	U.R.D.Co., LTD. CTL-12-S36-8 CTL-6-P(-H)
	Input accuracy	Full scale × (±1.0%)
	Number of alert delay	3 to 255
Number of occupied I/O points	32 points (I/O assignment: special 32 points)	
Connection terminal	20-point terminal block	
Applicable wire size	0.75 to 1.5mm ²	
Applicable solderless terminal	R1.25-3, 1.25-YS3, RAV1.25-3, V1.25-YS3A	
Internal current consumption	0.33A	0.42A
Weight	0.27kg	0.30kg
External dimensions	34.5(W) × 130(H) × 93.6(D)mm	

(1) List of usable platinum resistance thermometer, temperature measurement range, and resolution

Platinum resistance thermometer type	°C		°F	
	Temperature measurement range	Resolution	Temperature measurement range	Resolution
Pt100	-200.0 to 600.0	0.1	-300 to 1100	1
	-200.0 to 200.0		-300.0 to 300.0	0.1
JPt100	-200.0 to 500.0	0.1	-300 to 900	1
	-200.0 to 200.0		-300.0 to 300.0	0.1

○: Compatible, △: Partial change required, ×: Incompatible

Specifications		Compatibility	Precautions for replacement
Q64TCRTN	Q64TCRTBWN		
Between input terminal and programmable controller power supply: Transformer insulation Between input channels: Transformer insulation		○	
Between input terminal and programmable controller power supply: 500VAC, for 1 minute Between input channels: 500VAC, for 1 minute		○	
Between input terminal and programmable controller power supply: 500VDC, 20MΩ or more Between input channels: 500VDC, 20MΩ or more		○	
	U.R.D.Co., LTD. CTL-12-S36-8 CTL-12-S36-10 CTL-12-S56-10 CTL-6-P(-H)	○	
	Full scale × (±1.0%)		
	3 to 255		
16 points/slot (I/O assignment: intelligent 16 points)	32 points/2 slots (default I/O assignment Vacancy for 16 points + intelligent 16 points)	△	The number of occupied I/O points and slots are different.
18-point terminal block	Two 18-point terminal blocks	×	Wiring change is required.
22 to 18 AWG			
R1.25-3			
0.29A	0.33A	△	Recalculation of internal current consumption (5VDC) is required.
0.17kg	0.28kg	△	
27.4(W) × 98(H) × 112(D)mm	55.2(W) × 98(H) × 112(D)mm	-	

6.2.5 A1S62TCTT(BW)-S2

Item		Specifications		
		A1S62TCTT-S2	A1S62TCTTBW-S2	
Control output		Transistor output		
Number of temperature input points		2 channels/module		
Applicable temperature sensor		(Refer to Section 6.2.5 (1).)		
Accuracy	Indication accuracy		(Ambient temperature: 25±5°C) Full scale × (±0.3%) ± 1 digit	
			(Ambient temperature: 0 to 55°C) Full scale × (±0.7%) ± 1 digit	
	Cold junction temperature compensation accuracy: (ambient temperature: 0 to 55°C)	Temperature process value (PV): -100°C or more	Within ±1.0°C	
		Temperature process value (PV): -150 to -100°C	Within ±2.0°C	
Temperature process value (PV): -200 to -150°C		Within ±3.0°C		
Sampling cycle		0.5s (Constant regardless of the number of channels used)		
Control output cycle		1 to 100s		
Input impedance		1MΩ		
Input filter		0 to 100s		
Sensor correction value setting		-50.00 to 50.00%		
Operation at sensor input disconnection		Upscale processing		
Temperature control method		PID ON/OFF pulse or two-position control		
PID constants range	PID constants setting		Can be set by auto-tuning.	
	Proportional band (P)		0.0 to 1000.0%	
	Integral time (I)		1 to 3600s	
	Derivative time (D)		0 to 3600s	
Set value (SV) setting range		Within the temperature range set for the temperature sensor to be used		
Transistor output	Output signal		ON/OFF pulse	
	Rated load voltage		10.2 to 30VDC	
	Max. load current		0.1A/point, 0.4A/common	
	Max. inrush current		0.4A 10ms	
	Leakage current at OFF		0.1mA or less	
	Max. voltage drop at ON		1.0VDC (TYP) at 0.1A 2.5VDC (MAX) at 0.1A	
	Response time		OFF→ON: 2ms or less, ON→OFF: 2ms or less	
Number of writes to E ² PROM		Max. 100,000 times		

○: Compatible, △: Partial change required, ×: Incompatible

	Specifications		Compatibility	Precautions for replacement
	Q64TCTTN	Q64TCTBWN		
	Transistor output		○	
	4 channels/module		○	
	(Refer to Section 6.2.5 (1).)		○	
	(Ambient temperature: 25±5°C) Full scale × (±0.3%)* ¹		○	
	(Ambient temperature: 0 to 55°C) Full scale × (±0.7%)* ¹			
	Within ±1.0°C* ¹		○	
	Within ±2.0°C* ¹			
	Within ±3.0°C* ¹			
	0.5s (Constant regardless of the number of channels used)		○	
	1 to 100s		○	
	1MΩ		○	
	0 to 100s		○	
	-50.00 to 50.00%		○	
	Upscale processing		○	
	PID ON/OFF pulse or two-position control		○	
	Can be set by auto-tuning or self-tuning.		○	
	0.0 to 1000.0%		○	
	0 to 3600s		○	
	0 to 3600s		○	
	Within the temperature range set for the temperature sensor to be used		○	
	ON/OFF pulse		○	
	10 to 30VDC		○	
	0.1A/point, 0.4A/common		○	
	0.4A, 10ms		○	
	0.1mA or less		○	
	1.0VDC (TYP) at 0.1A 2.5VDC (MAX) at 0.1A		○	
	OFF→ON: 2ms or less, ON→OFF: 2ms or less		○	
	Max. 10 ¹² times (number of read/write from/to a non-volatile memory)		○	

*1 Calculate the accuracy in the following method (only when it is not affected by noise).
Accuracy (°C) = full scale × indication accuracy + cold junction temperature compensation accuracy

(Example) Accuracy at the input range of 38 (-200.0 to 400.0°C), the operating ambient temperature of 35°C, and the temperature process value (PV) of 300°C

(Full scale) × (indication accuracy) + cold junction temperature compensation accuracy
= (400.0°C - (-200.0°C)) × (±0.007) + (±1.0°C)
= ±5.2°C

Item	Specifications	
	A1S62TCTT-S2	A1S62TCTTBW-S2
Insulation output	Between input terminal and programmable controller power supply: Transformer insulation Between input channels: Transformer insulation	
Dielectric withstand voltage	Between input terminal and programmable controller power supply: 500VAC, for 1 minute Between input channels: 500VAC, for 1 minute	
Insulation resistance	Between input terminal and programmable controller power supply: 500VDC, 10MΩ or more Between input channels: 500VDC, 10MΩ or more	
Heater disconnection detection specifications	Current sensor	U.R.D.Co., LTD. CTL-12-S36-8 CTL-6-P(-H)
	Input accuracy	Full scale × (±1.0%)
	Number of alert delay	3 to 255
Number of occupied I/O points	32 points (I/O assignment: special 32 points)	
Connection terminal	20-point terminal block	
Applicable wire size	0.75 to 1.5mm ²	
Applicable solderless terminal	R1.25-3, 1.25-YS3, RAV1.25-3, V1.25-YS3A	
Internal current consumption	0.19A	0.28A
Weight	0.25kg	0.28kg
External dimensions	34.5(W) × 130(H) × 93.6(D)mm	

(1) List of thermocouple type, temperature measurement range, and resolution

Thermocouple type	°C		°F	
	Temperature measurement range	Resolution	Temperature measurement range	Resolution
R	0 to 1700	1	0 to 3000	1
K	0 to 500	1	0 to 1000	1
	0 to 800		0 to 2400	
	0 to 1300			
	-200.0 to 400.0	0.1	0.0 to 1000.0	0.1
J	0.0 to 400.0	0.1	0.0 to 1000.0	0.1
	0.0 to 500.0			
	0.0 to 800.0			
	0 to 500	1	0 to 1000	1
0 to 800	0 to 1600			
0 to 1200	0 to 2100			
T	-200 to 400	1	0 to 700	1
	-200 to 200		-300 to 400	
	0 to 200			
	0 to 400			
	-200.0 to 400.0	0.1	0.0 to 700.0	0.1
	0.0 to 400.0			

(To the next page)

○: Compatible, △: Partial change required, ×: Incompatible

Specifications		Compatibility	Precautions for replacement
Q64TCTTN	Q64TCTTBWN		
Between input terminal and programmable controller power supply: Transformer insulation Between input channels: Transformer insulation		○	
Between input terminal and programmable controller power supply: 500VAC, for 1 minute Between input channels: 500VAC, for 1 minute		○	
Between input terminal and programmable controller power supply: 500VDC, 20MΩ or more Between input channels: 500VDC, 20MΩ or more		○	
	U.R.D.Co., LTD. CTL-12-S36-8 CTL-12-S36-10 CTL-12-S56-10 CTL-6-P(-H)	○	
	Full scale × (±1.0%)		
	3 to 255		
16 points/slot (I/O assignment: intelligent 16 points)	32 points/2 slots (default I/O assignment Vacancy for 16 points + intelligent 16 points)	△	The number of occupied I/O points and slots are different.
18-point terminal block	Two 18-point terminal blocks	×	Wiring change is required.
22 to 18 AWG			
R1.25-3			
0.29A	0.33A	△	Recalculation of internal current consumption (5VDC) is required.
0.17kg	0.28kg	△	
27.4(W) × 98(H) × 112(D)mm	55.2(W) × 98(H) × 112(D)mm	-	

(From the previous page)

Thermocouple type	°C		°F	
	Temperature measurement range	Resolution	Temperature measurement range	Resolution
S	0 to 1700	1	0 to 3000	1
B	400 to 1800	1	800 to 3000	1
E	0 to 400	1	0 to 1800	1
	0 to 1000			
N	0.0 to 700.0	0.1	-	-
	0 to 1300	1	0 to 2300	1
U	0 to 400	1	0 to 700	1
	-200 to 200		-300 to 400	
L	0.0 to 600.0	0.1	-	-
	0 to 400	1	0 to 800	1
	0 to 900		0 to 1600	
PLII	0.0 to 400.0	0.1	-	-
	0.0 to 900.0			
PLII	0 to 1200	1	0 to 2300	1
W5Re/W26Re	0 to 2300	1	0 to 3000	1

6.2.6 A1S62TCRT(BW)-S2

Item	Specifications	
	A1S62TCRT-S2	A1S62TCRTBW-S2
Control output	Transistor output	
Number of temperature input points	2 channels/module	
Applicable temperature sensor	(Refer to Section 6.2.6 (1).)	
Indication accuracy	(Ambient temperature: 25±5°C) Full scale × (±0.3%) ± 1 digit	
	(Ambient temperature: 0 to 55°C) Full scale × (±0.7%) ± 1 digit	
Sampling cycle	0.5s (Constant regardless of the number of channels used)	
Control output cycle	1 to 100s	
Input impedance	1MΩ	
Input filter	0 to 100s	
Sensor correction value setting	-50.00 to 50.00%	
Operation at sensor input disconnection	Upscale processing	
Temperature control method	PID ON/OFF pulse or two-position control	
PID constants range	PID constants setting	Can be set by auto-tuning.
	Proportional band (P)	0.0 to 1000.0%
	Integral time (I)	1 to 3600s
	Derivative time (D)	0 to 3600s
Set value (SV) setting range	Within the temperature range set for the temperature sensor to be used	
Transistor output	Output signal	ON/OFF pulse
	Rated load voltage	10.2 to 30VDC
	Max. load current	0.1A/point, 0.4A/common
	Max. inrush current	0.4A, 10ms
	Leakage current at OFF	0.1mA or less
	Max. voltage drop at ON	1.0VDC (TYP) at 0.1A 2.5VDC (MAX) at 0.1A
	Response time	OFF→ON: 2ms or less, ON→OFF: 2ms or less
Number of writes to E ² PROM	Max. 100,000 times	

○: Compatible, △: Partial change required, ×: Incompatible

	Specifications		Compatibility	Precautions for replacement
	Q64TCRTN	Q64TCRTBWN		
	Transistor output		○	
	4 channels/module		○	
	(Refer to Section 6.2.6 (1).)		○	
	(Ambient temperature: 25±5°C) Full scale × (±0.3%)* ¹		○	
	(Ambient temperature: 0 to 55°C) Full scale × (±0.7%)* ¹			
	0.5s (Constant regardless of the number of channels used)		○	
	1 to 100s		○	
	1MΩ		○	
	0 to 100s		○	
	-50.00 to 50.00%		○	
	Upscale processing		○	
	PID ON/OFF pulse or two-position control		○	
	Can be set by auto-tuning or self-tuning.		○	
	0.0 to 1000.0%		○	
	0 to 3600s		○	
	0 to 3600s		○	
	Within the temperature range set for the temperature sensor to be used		○	
	ON/OFF pulse		○	
	10 to 30VDC		○	
	0.1A/point, 0.4A/common		○	
	0.4A, 10ms		○	
	0.1mA or less		○	
	1.0VDC (TYP) at 0.1A		○	
	2.5VDC (MAX) at 0.1A			
	OFF→ON: 2ms or less, ON→OFF: 2ms or less		○	
	Max. 10 ¹² times (number of read/write from/to a non-volatile memory)		○	

*1 Calculate the accuracy in the following method (only when it is not affected by noise).
Accuracy (°C) = full scale × indication accuracy + cold junction temperature compensation accuracy

(Example) Accuracy at the input range of 38 (-200.0 to 400.0°C), the operating ambient temperature of 35°C, and the temperature process value (PV) of 300°C

$$\begin{aligned}
 & (\text{Full scale}) \times (\text{indication accuracy}) + \text{cold junction temperature compensation accuracy} \\
 & = (400.0^\circ\text{C} - (-200.0^\circ\text{C})) \times (\pm 0.007) + (\pm 1.0^\circ\text{C}) \\
 & = \pm 5.2^\circ\text{C}
 \end{aligned}$$

Item	Specifications	
	A1S62TCRT-S2	A1S62TCRTBW-S2
Insulation output	Between input terminal and programmable controller power supply: Transformer insulation Between input channels: Transformer insulation	
Dielectric withstand voltage	Between input terminal and programmable controller power supply: 500VAC, for 1 minute Between input channels: 500VAC, for 1 minute	
Insulation resistance	Between input terminal and programmable controller power supply: 500VDC, 10MΩ or more Between input channels: 500VDC, 10MΩ or more	
Heater disconnection detection specifications	Current sensor	U.R.D.Co., LTD. CTL-12-S36-8 CTL-6-P(-H)
	Input accuracy	Full scale × (±1.0%)
	Number of alert delay	3 to 255
Number of occupied I/O points	32 points (I/O assignment: special 32 points)	
Connection terminal	20-point terminal block	
Applicable wire size	0.75 to 1.5mm ²	
Applicable solderless terminal	R1.25-3, 1.25-YS3, RAV1.25-3, V1.25-YS3A	
Internal current consumption	0.19A	0.28A
Weight	0.25kg	0.28kg
External dimensions	34.5(W) × 130(H) × 93.6(D)mm	

(1) List of usable platinum resistance thermometer, temperature measurement range, and resolution

Platinum resistance thermometer type	°C		°F	
	Temperature measurement range	Resolution	Temperature measurement range	Resolution
Pt100	-200.0 to 600.0	0.1	-300 to 1100	1
	-200.0 to 200.0		-300.0 to 300.0	0.1
JPt100	-200.0 to 500.0	0.1	-300 to 900	1
	-200.0 to 200.0		-300.0 to 300.0	0.1

○: Compatible, △: Partial change required, ×: Incompatible

Specifications		Compatibility	Precautions for replacement
Q64TCRTN	Q64TCRTBWN		
Between input terminal and programmable controller power supply: Transformer insulation Between input channels: Transformer insulation		○	
Between input terminal and programmable controller power supply: 500VAC, for 1 minute Between input channels: 500VAC, for 1 minute		○	
Between input terminal and programmable controller power supply: 500VDC, 20MΩ or more Between input channels: 500VDC, 20MΩ or more		○	
	U.R.D.Co., LTD. CTL-12-S36-8 CTL-12-S36-10 CTL-12-S56-10 CTL-6-P(-H)	○	
	Full scale × (±1.0%)		
	3 to 255		
16 points/slot (I/O assignment: intelligent 16 points)	32 points/2 slots (default I/O assignment Vacancy for 16 points + intelligent 16 points)	△	The number of occupied I/O points and slots are different.
18-point terminal block	Two 18-point terminal blocks	×	Wiring change is required.
22 to 18 AWG			
R1.25-3			
0.29A	0.33A	△	Recalculation of internal current consumption (5VDC) is required.
0.17kg	0.28kg	△	
27.4(W) × 98(H) × 112(D)mm	55.2(W) × 98(H) × 112(D)mm	-	

6.3 Functional Comparison

Item	Description		
Auto tuning function	The temperature control module automatically sets the optimal PID constants.		
Self-tuning function	The temperature control module constantly monitors the control status, and if the control is affected by disturbance, automatically changes and/or sets PID constants for the optimum control.		
Forward/reverse action selection function	Heating control (reverse action) or cooling control (forward action) can be selected and controlled.		
RFB limiter function	Suppresses the manipulated value overshoot which frequently occurs when the set value (SV) is changed or the control target is changed.		
Sensor correction function	Reduces the difference between the measured value and actual temperature to zero when these two are different due to measurement conditions, etc.		
Unused channel setting	Sets not to execute PID operation for channels that do not perform temperature control.		
PID control forced stop	Forcibly stops an PID operation in the channel where temperature control is in process.		
Heater disconnection detection function	Measures the current that flows in the heater main circuit and detects disconnection.		
Output off-time current error detection function	An error of when the transistor output is off can be detected by measuring whether there is current flowing in the heater main circuit.		
Loop disconnection detection function	Detects errors in the control system (control loop) caused by a load (heater) disconnection, abnormal external operation device (such as magnet relay), or sensor disconnection.		
Data storage in E ² PROM	By backing up the buffer memory contents to E ² PROM, the load of sequence program can be reduced.		
Alert function	Monitors the process value (PV) and alerts the user.		
Output setting at CPU stop error	Whether to hold or clear temperature control output when a CPU stop error occurs can be selected.		
Control function	A control status can be specified by setting output signals and buffer memory.		
Online module change	A module can be changed without stopping the system.		
Heating-cooling control	Cooling method setting function	An auto tuning operation formula can be set according to the selected cooling system (water-cooling or air-cooling).	
	Overlap/dead band function	An temperature area can be set near the temperature where heating output and cooling output is switched: An overlap area where both are output or a dead band area where neither is output.	
	Temperature conversion function (using unused channels)	Utilizing input channels that are not used for the control (monitor channel 1, 2), temperature conversion can be performed.	

○: Available -: Not available

Temperature control module/Heating-cooling temperature control module						
	A1S64TCTRT, A1S64TCTRWB	A1S64TCTT-S1, A1S64TCTTBW-S1	A1S64TCRT-S1, A1S64TCRTBW-S1	A1S62TCTT-S2, A1S62TCTTBW-S2	A1S62TCRT-S2, A1S62TCRTBW-S2	Q64TCTTN, Q64TCTTBWN, Q64TCRTN, Q64TCRTBWN
	○	○	○	○	○	○
	○	-	-	-	-	○
	○	○	○	-	-	○
	○	○	○	○	○	○
	○	○	○	○	○	○
	○	○	○	○	○	○
	○	○	○	○	○	○
	○ (BW only)	○ (BW only)	○ (BW only)	○ (BW only)	○ (BW only)	○ (BW only)
	○ (BW only)	○ (BW only)	○ (BW only)	○ (BW only)	○ (BW only)	○ (BW only)
	○	○	○	-	-	○
	○ (FeRAM)	○	○	○	○	○
	○	○	○	○	○	○
	-	-	-	-	-	○
	○	○	○	○	○	○
	-	-	-	-	-	○ ^{*1}
	○	-	-	○	○	○
	○	-	-	○	○	○
	○	-	-	-	-	○

*1 Online module change is possible only with the QnPH and QnPRH CPU types.

6.4 I/O Signal Comparison

Sequence program change is required as the I/O signals differ.

For details of the I/O signals or sequence program, refer to the user's manual for each module.

6.4.1 A1S64TCTRT(BW) and Q series modules (standard control)

A1S64TCTRT(BW)				Q64TCTTN, Q64TCRTN*1 Q64TCTTBWN, Q64TCRTBWN				
Device No.	Signal name	Device No.	Signal name	Device No.	Signal name	Device No.	Signal name	
X0	Watchdog timer error flag	Y0	Use prohibited	X0	Module READY flag	Y0	Use prohibited	
X1	Temperature control module READY flag	Y1		X1	Setting/operation mode status	Y1	Setting/operation mode instruction	
X2	Write error flag	Y2		X2	Write error flag	Y2	Error reset instruction	
X3	Hardware error flag	Y3		X3	Hardware error flag	Y3	Use prohibited	
X4	CH1 tuning status flag	Y4		X4	CH1 Auto tuning status	Y4	CH1 Auto tuning instruction	
X5	CH2 tuning status flag	Y5		X5	CH2 Auto tuning status	Y5	CH2 Auto tuning instruction	
X6	CH3 tuning status flag	Y6		X6	CH3 Auto tuning status	Y6	CH3 Auto tuning instruction	
X7	CH4 tuning status flag	Y7		X7	CH4 Auto tuning status	Y7	CH4 Auto tuning instruction	
X8	FeRAM write complete flag	Y8		X8	E ² PROM write completion flag	Y8	E ² PROM backup instruction	
X9	Default value write complete flag	Y9		X9	Default value write completion flag	Y9	Default setting registration instruction	
XA	FeRAM write incomplete flag	YA		XA	E ² PROM write failure flag	YA	Use prohibited	
XB	Use prohibited	YB		XB	Setting change completion flag	YB	Setting change instruction	
XC	CH1 Alert occurrence flag	YC		XC	CH1 Alert occurrence flag	YC	CH1 PID control forced stop instruction	
XD	CH2 Alert occurrence flag	YD		XD	CH2 Alert occurrence flag	YD	CH2 PID control forced stop instruction	
XE	CH3 Alert occurrence flag	YE		XE	CH3 Alert occurrence flag	YE	CH3 PID control forced stop instruction	
XF	CH4 Alert occurrence flag	YF		XF	CH4 Alert occurrence flag	YF	CH4 PID control forced stop instruction	
X10	Use prohibited	Y10		X10	Module READY flag	Y10	Use prohibited	
X11		Y11		Setting/operation mode command	X11	Setting/operation mode status	Y11	Setting/operation mode instruction
X12		Y12		Error reset command	X12	Write error flag	Y12	Error reset instruction
X13		Y13		Use prohibited	X13	Hardware error flag	Y13	Use prohibited
X14		Y14	CH1 Auto-tuning command	X14	CH1 Auto tuning status	Y14	CH1 Auto tuning instruction	
X15		Y15	CH2 Auto-tuning command	X15	CH2 Auto tuning status	Y15	CH2 Auto tuning instruction	
X16		Y16	CH3 Auto-tuning command	X16	CH3 Auto tuning status	Y16	CH3 Auto tuning instruction	
X17		Y17	CH4 Auto-tuning command	X17	CH4 Auto tuning status	Y17	CH4 Auto tuning instruction	

A1S64TCTRT(BW)				Q64TCTTN, Q64TCRTN*1 Q64TCTTBWN, Q64TCRTBWN			
Device No.	Signal name	Device No.	Signal name	Device No.	Signal name	Device No.	Signal name
X18	Use prohibited	Y18	FeRAM backup command	X18	E ² PROM write completion flag	Y18	E ² PROM backup instruction
X19		Y19	Default setting registration command	X19	Default value write completion flag	Y19	Default setting registration instruction
X1A		Y1A	CH1 Forced PID control stop command	X1A	E ² PROM write failure flag	Y1A	Use prohibited
X1B		Y1B	CH2 Forced PID control stop command	X1B	Setting change completion flag	Y1B	Setting change instruction
X1C		Y1C	CH3 Forced PID control stop command	X1C	CH1 Alert occurrence flag	Y1C	CH1 PID control forced stop instruction
X1D		Y1D	CH4 Forced PID control stop command	X1D	CH2 Alert occurrence flag	Y1D	CH2 PID control forced stop instruction
X1E		Y1E	Use prohibited	X1E	CH3 Alert occurrence flag	Y1E	CH3 PID control forced stop instruction
X1F		Y1F		X1F	CH4 Alert occurrence flag	Y1F	CH4 PID control forced stop instruction

*1 For the Q64TCTTN and Q64TCRTN, X0 to XF and Y0 to YF are applied.
 For the Q64TCTTBWN and Q64TCRTBWN, X10 to X1F and Y10 to Y1F are applied.
 Depending on the use of the Q64TCTTN, Q64TCTTBWN, Q64TCRTN, and Q64TCRTBWN, some of the I/O signals listed in the table are prohibited to use.
 For details, refer to the user's manual for the module used.

6.4.2 A1S64TCTRT(BW) and Q series modules (heating-cooling control)

A1S64TCTRT(BW)				Q64TCTTN, Q64TCRTN*1 Q64TCTTBWN, Q64TCRTBWN				
Device No.	Signal name	Device No.	Signal name	Device No.	Signal name	Device No.	Signal name	
X0	Watchdog timer error flag	Y0	Use prohibited	X0	Module READY flag	Y0	Use prohibited	
X1	Temperature control module READY flag	Y1		X1	Setting/operation mode status	Y1	Setting/operation mode instruction	
X2	Write error flag	Y2		X2	Write error flag	Y2	Error reset instruction	
X3	Hardware error flag	Y3		X3	Hardware error flag	Y3	Use prohibited	
X4	CH1 tuning status flag	Y4		X4	CH1 Auto tuning status	Y4	CH1 Auto tuning instruction	
X5	CH2 tuning status flag	Y5		X5	CH2 Auto tuning status	Y5	CH2 Auto tuning instruction	
X6	Use prohibited	Y6		X6	Use prohibited	Y6	Use prohibited	
X7		Y7		X7		Y7		
X8	FeRAM write complete flag	Y8		X8	E ² PROM write completion flag	Y8	E ² PROM backup instruction	
X9	Default value write complete flag	Y9		X9	Default value write completion flag	Y9	Default setting registration instruction	
XA	FeRAM write incomplete flag	YA		XA	E ² PROM write failure flag	YA	Use prohibited	
XB	Use prohibited	YB		XB	Setting change completion flag	YB	Setting change instruction	
XC	CH1 Alert occurrence flag	YC		XC	CH1 Alert occurrence flag	YC	CH1 PID control forced stop instruction	
XD	CH2 Alert occurrence flag	YD		XD	CH2 Alert occurrence flag	YD	CH2 PID control forced stop instruction	
XE	Use prohibited	YE		XE	Use prohibited	YE	Use prohibited	
XF		YF		XF		YF		
X10		Y10		X10		Module READY flag		Y10
X11	Use prohibited	Y11		Setting/operation mode command	X11	Setting/operation mode status	Y11	Setting/operation mode instruction
X12		Y12		Error reset command	X12	Write error flag	Y12	Error reset instruction
X13		Y13		Use prohibited	X13	Hardware error flag	Y13	Use prohibited
X14		Y14	CH1 Auto-tuning command	X14	CH1 Auto tuning status	Y14	CH1 Auto tuning instruction	
X15		Y15	CH2 Auto-tuning command	X15	CH2 Auto tuning status	Y15	CH2 Auto tuning instruction	
X16		Y16	Use prohibited	X16	Use prohibited	Y16	Use prohibited	
X17		Y17		X17		Y17		
X18		Y18	FeRAM backup command	X18	E ² PROM write completion flag	Y18	E ² PROM backup instruction	
X19		Y19	Default setting registration command	X19	Default value write completion flag	Y19	Default setting registration instruction	
X1A		Y1A	CH1 Forced PID control stop command	X1A	E ² PROM write failure flag	Y1A	Use prohibited	

A1S64TCTRT(BW)				Q64TCTTN, Q64TCRTN*1 Q64TCTTBWN, Q64TCRTBWN			
Device No.	Signal name	Device No.	Signal name	Device No.	Signal name	Device No.	Signal name
X1B	Use prohibited	Y1B	CH2 Forced PID control stop command	X1B	Setting change completion flag	Y1B	Setting change instruction
X1C		Y1C	Use prohibited	X1C	CH1 Alert occurrence flag	Y1C	CH1 PID control forced stop instruction
X1D		Y1D		X1D	CH2 Alert occurrence flag	Y1D	CH2 PID control forced stop instruction
X1E		Y1E		X1E	Use prohibited	Y1E	Use prohibited
X1F		Y1F		X1F		Y1F	

*1 For the Q64TCTTN and Q64TCRTN, X0 to XF and Y0 to YF are applied.
 For the Q64TCTTBWN and Q64TCRTBWN, X10 to X1F and Y10 to Y1F are applied.
 Depending on the use of the Q64TCTTN, Q64TCTTBWN, Q64TCRTN, and Q64TCRTBWN, some of the I/O signal listed in the table are prohibited to use.
 For details, refer to the user's manual for the module used.

6.4.3 A1S64TCTT(BW)-S1/A1S64TCRT(BW)-S1 and Q series modules

A1S64TCTT(BW)-S1, A1S64TCRT(BW)-S1				Q64TCTTN, Q64TCRTN*1 Q64TCTTBWN, Q64TCRTBWN				
Device No.	Signal name	Device No.	Signal name	Device No.	Signal name	Device No.	Signal name	
X0	Watchdog timer error flag	Y0	Use prohibited	X0	Module READY flag	Y0	Use prohibited	
X1	Temperature control module READY flag	Y1		X1	Setting/operation mode status	Y1	Setting/operation mode instruction	
X2	Write error flag	Y2		X2	Write error flag	Y2	Error reset instruction	
X3	Hardware error flag	Y3		X3	Hardware error flag	Y3	Use prohibited	
X4	CH1 tuning status flag	Y4		X4	CH1 Auto tuning status	Y4	CH1 Auto tuning instruction	
X5	CH2 tuning status flag	Y5		X5	CH2 Auto tuning status	Y5	CH2 Auto tuning instruction	
X6	CH3 Auto tuning status	Y6		X6	CH3 Auto tuning status	Y6	CH3 Auto tuning instruction	
X7	CH4 Auto tuning status	Y7		X7	CH4 Auto tuning status	Y7	CH4 Auto tuning instruction	
X8	E ² PROM write completion flag	Y8		X8	E ² PROM write completion flag	Y8	E ² PROM backup instruction	
X9	Default value write complete flag	Y9		X9	Default value write completion flag	Y9	Default setting registration instruction	
XA	FeRAM write incomplete flag	YA		XA	E ² PROM write failure flag	YA	Use prohibited	
XB	Use prohibited	YB		XB	Setting change completion flag	YB	Setting change instruction	
XC	CH1 Alert occurrence flag	YC		XC	CH1 Alert occurrence flag	YC	CH1 PID control forced stop instruction	
XD	CH2 Alert occurrence flag	YD		XD	CH2 Alert occurrence flag	YD	CH2 PID control forced stop instruction	
XE	CH3 Alert occurrence flag	YE		XE	CH3 Alert occurrence flag	YE	CH3 PID control forced stop instruction	
XF	CH4 Alert occurrence flag	YF		XF	CH4 Alert occurrence flag	YF	CH4 PID control forced stop instruction	
X10	Use prohibited	Y10		X10	Module READY flag	Y10	Use prohibited	
X11		Y11		Setting/operation mode command	X11	Setting/operation mode status	Y11	Setting/operation mode instruction
X12		Y12		Error reset command	X12	Write error flag	Y12	Error reset instruction
X13		Y13		Use prohibited	X13	Hardware error flag	Y13	Use prohibited
X14		Y14	CH1 Auto-tuning command	X14	CH1 Auto tuning status	Y14	CH1 Auto tuning instruction	
X15		Y15	CH2 Auto-tuning command	X15	CH2 Auto tuning status	Y15	CH2 Auto tuning instruction	
X16		Y16	CH3 Auto tuning instruction	X16	CH3 Auto tuning status	Y16	CH3 Auto tuning instruction	
X17		Y17	CH4 Auto tuning instruction	X17	CH4 Auto tuning status	Y17	CH4 Auto tuning instruction	
X18		Y18	E ² PROM backup instruction	X18	E ² PROM write completion flag	Y18	E ² PROM backup instruction	
X19		Y19	Default setting registration command	X19	Default value write completion flag	Y19	Default setting registration instruction	
X1A	Y1A	CH1 Forced PID control stop command	X1A	E ² PROM write failure flag	Y1A	Use prohibited		

A1S64TCTT(BW)-S1, A1S64TCRT(BW)-S1				Q64TCTTN, Q64TCRTN*1 Q64TCTTBWN, Q64TCRTBWN			
Device No.	Signal name	Device No.	Signal name	Device No.	Signal name	Device No.	Signal name
X1B	Use prohibited	Y1B	CH2 Forced PID control stop command	X1B	Setting change completion flag	Y1B	Setting change instruction
X1C		Y1C	CH3 Forced PID control stop command	X1C	CH1 Alert occurrence flag	Y1C	CH1 PID control forced stop instruction
X1D		Y1D	CH4 Forced PID control stop command	X1D	CH2 Alert occurrence flag	Y1D	CH2 PID control forced stop instruction
X1E		Y1E	Use prohibited	X1E	CH3 Alert occurrence flag	Y1E	CH3 PID control forced stop instruction
X1F		Y1F		X1F	CH4 Alert occurrence flag	Y1F	CH4 PID control forced stop instruction

*1 For the Q64TCTTN and Q64TCRTN, X0 to XF and Y0 to YF are applied.
 For the Q64TCTTBWN and Q64TCRTBWN, X10 to X1F and Y10 to Y1F are applied.
 Depending on the use of the Q64TCTTN, Q64TCTTBWN, Q64TCRTN, and Q64TCRTBWN, some of the I/O signal listed in the table are prohibited to use.
 For details, refer to the user's manual for the module used.

6.4.4 A1S62TCTT(BW)-S2/A1S62TCRT(BW)-S2 and Q series modules

A1S62TCTT(BW)-S2, A1S62TCRT(BW)-S2				Q64TCTTN, Q64TCRTN*1 Q64TCTTBWN, Q64TCRTBWN			
Device No.	Signal name	Device No.	Signal name	Device No.	Signal name	Device No.	Signal name
X0	Watchdog timer error flag	Y0	Use prohibited	X0	Module READY flag	Y0	Use prohibited
X1	Temperature control module READY flag	Y1		X1	Setting/operation mode status	Y1	Setting/operation mode instruction
X2	Write error flag	Y2		X2	Write error flag	Y2	Error reset instruction
X3	Hardware error flag	Y3		X3	Hardware error flag	Y3	Use prohibited
X4	CH1 tuning status flag	Y4		X4	CH1 Auto tuning status	Y4	CH1 Auto tuning instruction
X5	CH2 tuning status flag	Y5		X5	CH2 Auto tuning status	Y5	CH2 Auto tuning instruction
X6	Use prohibited	Y6		X6	Use prohibited	Y6	Use prohibited
X7		Y7		X7		Y7	
X8	E ² PROM write completion flag	Y8		X8	E ² PROM write completion flag	Y8	E ² PROM backup instruction
X9	Default value write complete flag	Y9		X9	Default value write completion flag	Y9	Default setting registration instruction
XA	FeRAM write incomplete flag	YA		XA	E ² PROM write failure flag	YA	Use prohibited
XB	Use prohibited	YB		XB	Setting change completion flag	YB	Setting change instruction
XC	CH1 Alert occurrence flag	YC		XC	CH1 Alert occurrence flag	YC	CH1 PID control forced stop instruction
XD	CH2 Alert occurrence flag	YD		XD	CH2 Alert occurrence flag	YD	CH2 PID control forced stop instruction
XE	Use prohibited	YE		XE	Use prohibited	YE	Use prohibited
XF		YF		XF		YF	
X10		Y10		X10	Module READY flag	Y10	Use prohibited
X11		Y11		X11	Setting/operation mode status	Y11	Setting/operation mode instruction
X12	Y12	X12		Write error flag	Y12	Error reset instruction	
X13	Y13	X13		Hardware error flag	Y13	Use prohibited	
X14	Y14	X14	CH1 Auto-tuning command	Y14	CH1 Auto tuning instruction		
X15	Y15	X15	CH2 Auto-tuning command	Y15	CH2 Auto tuning instruction		
X16	Use prohibited	Y16	X16	Use prohibited	Y16	Use prohibited	
X17		Y17	X17		Y17		
X18	Y18	X18	E ² PROM write completion flag	Y18	E ² PROM backup instruction		
X19	Y19	X19	Default value write completion flag	Y19	Default setting registration instruction		
X1A	Y1A	X1A	E ² PROM write failure flag	Y1A	Use prohibited		

A1S62TCTT(BW)-S2, A1S62TCRT(BW)-S2				Q64TCTTN, Q64TCRTN*1 Q64TCTTBWN, Q64TCRTBWN			
Device No.	Signal name	Device No.	Signal name	Device No.	Signal name	Device No.	Signal name
X1B	Use prohibited	Y1B	CH2 Forced PID control stop command	X1B	Setting change completion flag	Y1B	Setting change instruction
X1C		Y1C	Use prohibited	X1C	CH1 Alert occurrence flag	Y1C	CH1 PID control forced stop instruction
X1D		Y1D		X1D	CH2 Alert occurrence flag	Y1D	CH2 PID control forced stop instruction
X1E		Y1E		X1E	Use prohibited	Y1E	Use prohibited
X1F		Y1F		X1F		Y1F	

*1 For the Q64TCTTN and Q64TCRTN, X0 to XF and Y0 to YF are applied.
 For the Q64TCTTBWN and Q64TCRTBWN, X10 to X1F and Y10 to Y1F are applied.
 Depending on the use of the Q64TCTTN, Q64TCTTBWN, Q64TCRTN, and Q64TCRTBWN, some of the I/O signal listed in the table are prohibited to use.
 For details, refer to the user's manual for the module used.

6.5 Buffer Memory Address Comparison

Sequence program change is required as the assignment of buffer memory differs.
For details of the buffer memory or sequence program, refer to the user's manual for each module.

6.5.1 A1S64TCTRT(BW) and Q series modules (standard control)

A1S64TCTRT(BW)						
Address (hexadecimal)				Name	Read/write	
CH1	CH2	CH3	CH4			
0				Error code	R	
1	2	3	4	Decimal point position		
5	6	7	8	Alert detail		
9	A	B	C	Temperature process value (PV)		
D	E	F	10	Manipulated value (MV)		
11	12	13	14	Temperature rise judgment flag		
15	16	17	18	Transistor output flag		
19	1A	1B	1C	Measured heater current value		
1D				Cold junction temperature process value		
1E				MAN mode shift completion flag		
1F				System area (Use prohibited)	-	
20	40	60	80	Input range	R/W	
21	41	61	81	Stop mode setting		
22	42	62	82	Set value (SV) setting		
23	43	63	83	Proportional band (P) setting		
24	44	64	84	Integral time (I) setting		
25	45	65	85	Derivative time (D) setting		
26	46	66	86	Setting of Alert alarm 1		
27	47	67	87	Setting of Alert alarm 2		
28	48	68	88	Setting of Alert alarm 3		
29	49	69	89	Setting of Alert alarm 4		
2A	4A	6A	8A	Upper output limiter		
2B	4B	6B	8B	Lower output limiter		
2C	4C	6C	8C	Output variation limiter		
2D	4D	6D	8D	Sensor compensation value setting		
2E	4E	6E	8E	Adjustment sensitivity (dead band) setting		
2F	4F	6F	8F	Control output period setting		
30	50	70	90	Primary delay digital filter setting		
31	51	71	91	Control response parameter		
32	52	72	92	AUTO/MAN mode switching		
33	53	73	93	MAN output setting		
34	54	74	94	Setting change rate limiter		
35	55	75	95	AT bias		
36	56	76	96	Direct/reverse action setting		
37	57	77	97	Upper setting limiter		
38	58	78	98	Lower setting limiter		
39	59	79	99	CT selection		
3A	5A	7A	9A	Heater disconnection alert setting		
3B	5B	7B	9B	Loop disconnection detection judgment time		
3C	5C	7C	9C	Loop disconnection detection dead band		
3D	5D	7D	9D	Unused channel setting		

Q64TCTTN, Q64TCRTN, Q64TCTTBWN, Q64TCRTBWN					
Address (hexadecimal)				Name	Read/write
CH1	CH2	CH3	CH4		
0				Write data error code	R
1	2	3	4	Decimal point position	
5	6	7	8	Alert definition	
9	A	B	C	Temperature process value (PV)	
D	E	F	10	Manipulated value (MV)	
11	12	13	14	Temperature rise judgment flag	
15	16	17	18	Transistor output flag	
19	1A	1B	1C	Set value (SV) monitor	
1D				Cold junction temperature process value ^{*1}	
1E				MAN mode shift completion flag	
1F				System area (Use prohibited)	-
20	40	60	80	Input range	R/W
21	41	61	81	Stop mode setting	
22	42	62	82	Set value (SV) setting	
23	43	63	83	Proportional band (P) setting	
24	44	64	84	Integral time (I) setting	
25	45	65	85	Derivative time (D) setting	
26	46	66	86	Alert set value 1	
27	47	67	87	Alert set value 2	
28	48	68	88	Alert set value 3	
29	49	69	89	Alert set value 4	
2A	4A	6A	8A	Upper limit output limiter	
2B	4B	6B	8B	Lower limit output limiter	
2C	4C	6C	8C	Output variation limiter setting	
2D	4D	6D	8D	Sensor correction value setting	
2E	4E	6E	8E	Adjustment sensitivity (dead band) setting	
2F	4F	6F	8F	Control output cycle setting	
30	50	70	90	Primary delay digital filter setting	
31	51	71	91	Control response parameter	
32	52	72	92	AUTO/MAN mode shift	
33	53	73	93	MAN output setting	
34	54	74	94	Setting change rate limiter	
35	55	75	95	AT bias	
36	56	76	96	Forward/reverse action setting	
37	57	77	97	Upper limit setting limiter	
38	58	78	98	Lower limit setting limiter	
39	59	79	99	System area (Use prohibited)	-
3A	5A	7A	9A	Heater disconnection alert setting	R/W
3B	5B	7B	9B	Loop disconnection detection judgment time	
3C	5C	7C	9C	Loop disconnection detection dead band	
3D	5D	7D	9D	Unused channel setting	

*1 For the Q64TCRT(BW)N, this area is prohibited to use.

A1S64TCTRT(BW)						
Address (hexadecimal)				Name	Read/write	
CH1	CH2	CH3	CH4			
3E	5E	7E	9E	Self-tuning setting	R/W	
3F	5F	7F	9F	Self-tuning flag	R	
A0				Mode setting for Alert alarm 1	R/W	
A1				Mode setting for Alert alarm 2		
A2				Mode setting for Alert alarm 3		
A3				Mode setting for Alert alarm 4		
A4				Alert dead band setting		
A5				Alert delay count		
A6				Heater disconnection/output off-time current error detection delay count		
A7				Temperature rise completion range setting		
A8				Temperature rise completion soak time setting		
A9				PID continuation flag		
AA				Heater voltage compensation setting		
AB	AC	AD	AE	Heater current reference value		
AF				Transistor output monitor ON delay time setting		
B0				CT monitor method switching		
B1	B2	B3	B4	Control output monitor	R	
B5				System area (Use prohibited)	-	
B6				Cold junction temperature compensation selection	R/W	
B7				Control switching monitor	R	

☒ Point

Default values for A series modules and Q series modules may be different.
 To apply an A series program using a default value to a Q series module, review the program.
 For details, refer to the user's manual for the Q series module used.

Q64TCTTN, Q64TCRTN, Q64TCTTBWN, Q64TCRTBWN					Name	Read/write
Address (hexadecimal)				Name		
CH1	CH2	CH3	CH4			
3E	5E	7E	9E	E ² PROM's PID constants read instruction	R/W	
3F	5F	7F	9F	Automatic backup setting after auto tuning of PID constants		
A0				System area (Use prohibited)	-	
A1						
A2						
A3						
A4				Alert dead band setting	R/W	
A5				Number of alert delay		
A6				Heater disconnection/output off-time current error detection delay count		
A7				Temperature rise completion range setting		
A8				Temperature rise completion soak time setting		
A9				PID continuation flag		
AA				Heater disconnection correction function selection		
AB	AC	AD	AE	System area (Use prohibited)		-
AF				Transistor output monitor ON delay time setting	R/W	
B0				CT monitor method switching		
B1	B2	B3	B4	Manipulated value (MV) for output with another analog module	R	
B5				Resolution of the manipulated value for output with another analog module	R/W	
B6				Cold junction temperature compensation selection	R/W	
B7				Control switching monitor	-	
B8	B9	BA	BB	Auto tuning mode selection	R/W	
BC to BF				System area (Use prohibited)	-	
C0	D0	E0	F0	Alert 1 mode setting	R/W	
C1	D1	E1	F1	Alert 2 mode setting		
C2	D2	E2	F2	Alert 3 mode setting		
C3	D3	E3	F3	Alert 4 mode setting		
C4 to CF	D4 to DF	E4 to EF	F4 to FF	System area (Use prohibited)	-	
100 to 107				Heater current process value	R	
108 to 10F				CT input channel assignment setting	R/W	
110 to 117				CT selection		
118 to 11F				Reference heater current value		
to						
23E	25E	27E	29E	Self-tuning setting	R/W	
23F	25F	27F	29F	Self-tuning flag	R	

6.5.2 A1S64TCTRT(BW) and Q series modules (heating-cooling control)

A1S64TCTRT(BW)			
Address (hexadecimal)		Name	Read/write
CH1	CH2		
0		Error code	R
1	2	Decimal point position	
5	6	Alert detail	
9	A	Temperature process value (PV)	
D	E	Manipulated value for heating (MVh)	
11	12	Temperature rise judgment flag	
15	16	Heating transistor output flag	
19	1A	Measured heater current value	
1D		Cold junction temperature process value	
1E		System area (Use prohibited)	
1F			
20	40	Input range	R/W
21	41	Stop mode setting	
22	42	Set value (SV) setting	
23	43	Heating proportional band (Ph) setting	
24	44	Integral time (I) setting	
25	45	Derivative time (D) setting	
26	46	Setting of Alert alarm 1	
27	47	Setting of Alert alarm 2	
28	48	Setting of Alert alarm 3	
29	49	Setting of Alert alarm 4	
2A	4A	Heating upper output limiter	-
2B	4B	System area (Use prohibited)	
2C	4C	System area (Use prohibited)	R/W
2D	4D	Sensor compensation value setting	
2E	4E	System area (Use prohibited)	-
2F	4F	Heating control output period setting	
30	50	Primary delay digital filter setting	R/W
31	51	Control response parameter	
32	52	System area (Use prohibited)	-
33	53	System area (Use prohibited)	
34	54	Setting change rate limiter	R/W
35	55	System area (Use prohibited)	-
36	56	System area (Use prohibited)	
37	57	Upper setting limiter	
38	58	Lower setting limiter	
39	59	CT selection	R/W
3A	5A	Heater disconnection alert setting	
3B	5B	System area (Use prohibited)	-
3C	5C	System area (Use prohibited)	
3D	5D	Unused channel setting	R/W

Q64TCTTN, Q64TCRTN, Q64TCTTBWN, Q64TCRTBWN			
Address (hexadecimal)		Name	Read/write
CH1	CH2		
0		Write data error code	R
1	2	Decimal point position	
5	6	Alert definition	
9	A	Temperature process value (PV)	
D	E	Manipulated value for heating (MVh)	
11	12	Temperature rise judgment flag	
15	16	Heating transistor output flag	
19	1A	Set value (SV) monitor	
1D		Cold junction temperature process value* ¹	
1E		MAN mode shift completion flag	-
1F		System area (Use prohibited)	
20	40	Input range	R/W
21	41	Stop mode setting	
22	42	Set value (SV) setting	
23	43	Heating proportional band (Ph) setting	
24	44	Integral time (I) setting	
25	45	Derivative time (D) setting	
26	46	Alert set value 1	
27	47	Alert set value 2	
28	48	Alert set value 3	
29	49	Alert set value 4	
2A	4A	Heating upper limit output limiter	-
2B	4B	System area (Use prohibited)	
2C	4C	Output variation limiter setting	R/W
2D	4D	Sensor correction value setting	
2E	4E	Adjustment sensitivity (dead band) setting	
2F	4F	Heating control output cycle setting	
30	50	Primary delay digital filter setting	
31	51	Control response parameter	
32	52	AUTO/MAN mode shift	
33	53	MAN output setting	
34	54	Setting change rate limiter	
35	55	AT bias	
36	56	System area (Use prohibited)	-
37	57	Upper limit setting limiter	R/W
38	58	Lower limit setting limiter	
39	59	System area (Use prohibited)	-
3A	5A	Heater disconnection alert setting	R/W
3B	5B	System area (Use prohibited)	-
3C	5C		
3D	5D	Unused channel setting	R/W

*1 For the Q64TCRT(BW)N, this area is prohibited to use.

A1S64TCTRT(BW)			
Address (hexadecimal)		Name	Read/write
CH1	CH2		
3E	5E	System area (Use prohibited)	-
3F	5F		
A0		Mode setting for Alert alarm 1	R/W
A1		Mode setting for Alert alarm 2	
A2		Mode setting for Alert alarm 3	
A3		Mode setting for Alert alarm 4	
A4		Alert dead band setting	
A5		Alert delay count	
A6		Heater disconnection/output off-time current error detection delay count	
A7		Temperature rise completion range setting	
A8		Temperature rise completion soak time setting	
A9		PID continuation flag	
AA		Heater voltage compensation setting	
AB	AC	Heater current reference value	
AF		Transistor output monitor ON delay time setting	
B0		CT monitor method switching	
B1	B2	Heating control output monitor	R
	to		
B6		Cold junction temperature compensation selection	R/W
B7		Control switching monitor	R
B8	B9	Temperature conversion setting	R/W
	to		
C0	C1	Manipulated value for cooling (MV)	R
C2	C3	Cooling control output monitor	
C4	C5	Cooling transistor output flag	
	to		
	CF	Cooling type setting	R/W
D0	E0	Cooling proportional band (Pc) setting	
D1	E1	Cooling upper output limiter	
D2	E2	Cooling control output period setting	
D3	E3	Overlap/dead band	

☒ Point

Default values for A series modules and Q series modules may be different.
 To apply an A series program using a default value to a Q series module, review the program.
 For details, refer to the user's manual for the Q series module used.

Q64TCTTN, Q64TCRTN, Q64TCTTBWN, Q64TCRTBWN			
Address (hexadecimal)		Name	Read/write
CH1	CH2		
3E	5E	E ² PROM's PID constants read instruction	R/W
3F	5F	Automatic backup setting after auto tuning of PID constants	
A0		System area (Use prohibited)	-
A1			
A2			
A3			
A4		Alert dead band setting	R/W
A5		Number of alert delay	
A6		Heater disconnection/output off-time current error detection delay count	
A7		Temperature rise completion range setting	
A8		Temperature rise completion soak time setting	
A9		PID continuation flag	
AA		Heater disconnection correction function selection	
AB	AC	System area (Use prohibited)	
AF		Transistor output monitor ON delay time setting	R/W
B0		CT monitor method switching	
B1	B2	Manipulated value of heating (MVh) for output with another analog module	R
B5		Resolution of the manipulated value for output with another analog module	R/W
B6		Cold junction temperature compensation selection	
B7		Control switching monitor	R
B8	B9	Auto tuning mode selection	R/W
BC to BF		System area (Use prohibited)	-
C0	D0	Alert 1 mode setting	R/W
C1	D1	Alert 2 mode setting	
C2	D2	Alert 3 mode setting	
C3	D3	Alert 4 mode setting	
C4 to CF	D4 to DF	System area (Use prohibited)	-
100 to 107		Heater current process value	R
108 to 10F		CT input channel assignment setting	R/W
110 to 117		CT selection	
118 to 11F		Reference heater current value	
to			
2B8	2B9	Temperature conversion setting	R/W
to		System area (Use prohibited)	-
2C0	2C1	Manipulated value for cooling (MVc)	R
to			
2C4	2C5	Manipulated value of cooling (MVc) for output with another analog module	R
to			
2C8	2C9	Cooling transistor output flag	R
to			
2CF		Cooling method setting	R/W
2D0	2E0	Cooling proportional band (Pc) setting	
2D1	2E1	Cooling upper limit output limiter	
2D2	2E2	Cooling control output cycle setting	
2D3	2E3	Overlap/dead band setting	

6.5.3 A1S64TCTT(BW)-S1/A1S64TCRT(BW)-S1 and Q series modules

A1S64TCTT(BW)-S1, A1S64TCRT(BW)-S1					
Address (hexadecimal)				Name	Read/write
CH1	CH2	CH3	CH4		
0				Write data error code	R/W
1	2	3	4	Decimal point position	R
5	6	7	8	Alert details	
9	A	B	C	Temperature process value (PV)	
D	E	F	10	Manipulation value (MV)	
11	12	13	14	Increased temperature determination flag	
15	16	17	18	Transistor output flag	
19	1A	1B	1C	Heater current process value	
1D				Cooling contact temperature process value*1	
1E				Switch to manual mode completion flag	
1F				System area (Use prohibited)	
20	40	60	80	Input range	R/W
21	41	61	81	Stop mode setting	
22	42	62	82	Set value (SV) setting	
23	43	63	83	Proportional band (P) setting	
24	44	64	84	Integral time (I) setting	
25	45	65	85	Derivative time (D) setting	
26	46	66	86	Alert alarm 1 set value	
27	47	67	87	Alert alarm 2 set value	
28	48	68	88	Alert alarm 3 set value	
29	49	69	89	Alert alarm 4 set value	
2A	4A	6A	8A	Upper output limiter	
2B	4B	6B	8B	Lower output limiter	
2C	4C	6C	8C	Output variation limiter	
2D	4D	6D	8D	Sensor compensation value setting	
2E	4E	6E	8E	Adjustment sensitivity (blind section) setting	
2F	4F	6F	8F	Control output period setting	
30	50	70	90	First-order delay digital filter setting	
31	51	71	91	Control response parameter	
32	52	72	92	AUTO/MAN mode switch	
33	53	73	93	Manual output setting	
34	54	74	94	Setting change rate limiter	
35	55	75	95	AT bias	
36	56	76	96	Forward/reverse action setting	
37	57	77	97	Upper setting limiter	
38	58	78	98	Lower setting limiter	
39	59	79	99	CT selection	
3A	5A	7A	9A	Heater disconnection alert setting	
3B	5B	7B	9B	Open-loop detection time	
3C	5C	7C	9C	Open-loop detection dead band	
3D	5D	7D	9D	Unused channel setting	

*1 For the A1S64TCRT(BW)-S1, this area is prohibited to use.

*2 For the Q64TCRT(BW) and Q64TCRT(BW)N, this area is prohibited to use.

Q64TCTTN, Q64TCRTN, Q64TCTTBWN, Q64TCRTBWN						
Address (hexadecimal)				Name	Read/write	
CH1	CH2	CH3	CH4			
0				Write data error code	R	
1	2	3	4	Decimal point position		
5	6	7	8	Alert definition		
9	A	B	C	Temperature process value (PV)		
D	E	F	10	Manipulated value (MV)		
11	12	13	14	Temperature rise judgment flag		
15	16	17	18	Transistor output flag		
19	1A	1B	1C	Set value (SV) monitor		
1D				Cold junction temperature process value*2		
1E				MAN mode shift completion flag		
1F				System area (Use prohibited)	-	
20	40	60	80	Input range	R/W	
21	41	61	81	Stop mode setting		
22	42	62	82	Set value (SV) setting		
23	43	63	83	Proportional band (P) setting		
24	44	64	84	Integral time (I) setting		
25	45	65	85	Derivative time (D) setting		
26	46	66	86	Alert set value 1		
27	47	67	87	Alert set value 2		
28	48	68	88	Alert set value 3		
29	49	69	89	Alert set value 4		
2A	4A	6A	8A	Upper limit output limiter		
2B	4B	6B	8B	Lower limit output limiter		
2C	4C	6C	8C	Output variation limiter setting		
2D	4D	6D	8D	Sensor correction value setting		
2E	4E	6E	8E	Adjustment sensitivity (dead band) setting		
2F	4F	6F	8F	Control output cycle setting		
30	50	70	90	Primary delay digital filter setting		
31	51	71	91	Control response parameter		
32	52	72	92	AUTO/MAN mode shift		
33	53	73	93	MAN output setting		
34	54	74	94	Setting change rate limiter		
35	55	75	95	AT bias		
36	56	76	96	Forward/reverse action setting		
37	57	77	97	Upper limit setting limiter		
38	58	78	98	Lower limit setting limiter		
39	59	79	99	System area (Use prohibited)		-
3A	5A	7A	9A	Heater disconnection alert setting		R/W
3B	5B	7B	9B	Loop disconnection detection judgment time		
3C	5C	7C	9C	Loop disconnection detection dead band		
3D	5D	7D	9D	Unused channel setting		

A1S64TCTT(BW)-S1, A1S64TCRT(BW)-S1						
Address (hexadecimal)				Name	Read/write	
CH1	CH2	CH3	CH4			
3E	5E	7E	9E	System area (Use prohibited)	-	
3F	5F	7F	9F			
A0				Alert alarm 1 mode setting	R/W	
A1				Alert alarm 2 mode setting		
A2				Alert alarm 3 mode setting		
A3				Alert alarm 4 mode setting		
A4				Alert blind section setting		
A5				Number of alert delays		
A6				Number of delays for heater disconnection/current error detection when output is turned off		
A7				Temperature increase complete range setting		
A8				Temperature increase complete soak time setting		
A9				PID continue flag		
AA				Heater voltage compensation function setting		
AB	AC	AD	AE	Standard heater current value		
AF				Transistor output monitor on delay time setting		
B0				CT monitor method switch		
B1	B2	B3	B4	Manipulation value (MV) (0 to 4000)	R	
B5				System area (Use prohibited)	-	
B6				Cold junction temperature compensation selection*1 (This area can be used with the software version F or later.)	R/W	

*1 For the A1S64TCRT(BW)-S1, this area is prohibited to use.

☒ Point

Default values for A series modules and Q series modules may be different.

To apply an A series program using a default value to a Q series module, review the program.

For details, refer to the user's manual for the Q series module used.

Q64TCTTN, Q64TCRTN, Q64TCTTBWN, Q64TCRTBWN					
Address (hexadecimal)				Name	Read/write
CH1	CH2	CH3	CH4		
3E	5E	7E	9E	E ² PROM's PID constants read instruction	R/W/-
3F	5F	7F	9F	Automatic backup setting after auto tuning of PID constants	
A0				System area (Use prohibited)	-
A1					
A2					
A3					
A4					
A5				Alert dead band setting	R/W
A6				Number of alert delay	
A7				Heater disconnection/output off-time current error detection delay count	
A8				Temperature rise completion range setting	
A9				Temperature rise completion soak time setting	
AA				PID continuation flag	
AB				Heater disconnection correction function selection	
AB	AC	AD	AE	System area (Use prohibited)	-
AF				Transistor output monitor ON delay time setting	R/W
B0				CT monitor method switching	
B1	B2	B3	B4	Manipulated value (MV) for output with another analog module	R
B5				Resolution of the manipulated value for output with another analog module	R/W
B6				Cold junction temperature compensation selection	
B7				Control switching monitor	R
B8	B9	BA	BB	Auto tuning mode selection	R/W
BC to BF				System area (Use prohibited)	-
C0	D0	E0	F0	Alert 1 mode setting	R/W
C1	D1	E1	F1	Alert 2 mode setting	
C2	D2	E2	F2	Alert 3 mode setting	
C3	D3	E3	F3	Alert 4 mode setting	
C4 to CF	D4 to DF	E4 to EF	F4 to FF	System area (Use prohibited)	-
100 to 107				Heater current process value	R
108 to 10F				CT input channel assignment setting	R/W
110 to 117				CT selection	
118 to 11F				Reference heater current value	
to					
23E	25E	27E	29E	Self-tuning setting	R/W
23F	25F	27F	29F	Self-tuning flag	R

6.5.4 A1S62TCTT(BW)-S2/A1S62TCRT(BW)-S2 and Q series modules

A1S62TCTT(BW)-S2, A1S62TCRT(BW)-S2			
Address (hexadecimal)		Name	Read/write
CH1	CH2		
0		Write data error code	R
1	2	Decimal point position	
5	6	Alert occurrence details	
9	A	Temperature process value (PV)	
D	E	Heating manipulation value (MV)	
11	12	Increased temperature determination flag	
15	16	Heating transistor output flag	
19	1A	Heater current process value	
1D		Cooling contact temperature process value*1	
1E		System area (Use prohibited)	
1F			
20	40	Input range	R/W
21	41	Stop mode setting	
22	42	Set value (SV) setting	
23	43	Heating proportional band (Ph) setting	
24	44	Integral time (I) setting	
25	45	Derivative time (D) setting	
26	46	Alert set value 1	
27	47	Alert set value 2	
28	48	Alert set value 3	
29	49	Alert set value 4	
2A	4A	Heating-cooling upper output limiter setting	-
2B	4B	System area (Use prohibited)	
2C	4C	System area (Use prohibited)	R/W
2D	4D	Sensor compensation value setting	
2E	4E	System area (Use prohibited)	-
2F	4F	Heating control output cycle setting	
30	50	First-order delay digital filter setting	R/W
31	51	Control response parameter	
32	52	System area (Use prohibited)	-
33	53	System area (Use prohibited)	
34	54	Setting change rate limiter	R/W
35	55	System area (Use prohibited)	-
36	56	System area (Use prohibited)	
37	57	Upper setting limiter	R/W
38	58	Lower setting limiter	
39	59	CT selection	
3A	5A	Heater wire breakage alert setting	
3B	5B	System area (Use prohibited)	-
3C	5C	System area (Use prohibited)	
3D	5D	Not used channel setting	R/W

*1 For the A1S62TCRT(BW), this area is prohibited to use.

*2 For the Q64TCRT(BW)N, this area is prohibited to use.

Q64TCTTN, Q64TCRTN, Q64TCTTBWN, Q64TCRTBWN			
Address (hexadecimal)		Name	Read/write
CH1	CH2		
0		Write data error code	R
1	2	Decimal point position	
5	6	Alert definition	
9	A	Temperature process value (PV)	
D	E	Manipulated value for heating (MVh)	
11	12	Temperature rise judgment flag	
15	16	Heating transistor output flag	
19	1A	Set value (SV) monitor	
1D		Cold junction temperature process value ^{*2}	
1E		MAN mode shift completion flag	
1F		E ² PROM's PID constants read/write completion flag	
20	40	Input range	R/W
21	41	Stop mode setting	
22	42	Set value (SV) setting	
23	43	Heating proportional band (Ph) setting	
24	44	Integral time (I) setting	
25	45	Derivative time (D) setting	
26	46	Alert set value 1	
27	47	Alert set value 2	
28	48	Alert set value 3	
29	49	Alert set value 4	
2A	4A	Upper limit output limiter	
2B	4B	Lower limit output limiter	
2C	4C	Output variation limiter setting	
2D	4D	Sensor correction value setting	
2E	4E	Adjustment sensitivity (dead band) setting	
2F	4F	Heating control output cycle setting	
30	50	Primary delay digital filter setting	
31	51	Control response parameter	
32	52	AUTO/MAN mode shift	
33	53	MAN output setting	
34	54	Setting change rate limiter	
35	55	AT bias	
36	56	System area (Use prohibited)	-
37	57	Upper limit setting limiter	R/W
38	58	Lower limit setting limiter	
39	59	System area (Use prohibited)	-
3A	5A	Heater disconnection alert setting	R/W
3B	5B	System area (Use prohibited)	-
3C	5C		
3D	5D	Unused channel setting	R/W

A1S62TCTT(BW)-S2, A1S62TCRT(BW)-S2			
Address (hexadecimal)		Name	Read/write
CH1	CH2		
3E	5E	System area (Use prohibited)	-
3F	5F		
A0			
A1		Alert alarm 1 mode setting	R/W
A2		Alert alarm 2 mode setting	
A3		Alert alarm 3 mode setting	
A4		Alert alarm 4 mode setting	
A5		Alert blind section setting	
A6		Number of alert delays	
A7		Number of delays for heater wire breakage/current error detection when output is turned off	
A8		Temperature increase complete range setting	
A9		Temperature increase complete soak time setting	
A9		PID continue flag	
AA		Heater voltage compensation function setting	
AB	AC	Standard heater current value	
AF		Transistor output monitor ON delay time setting	
B0		CT monitor method switch	
B1	B2	Heating manipulated value (MV) (0 to 4000)	
B5		System area (Use prohibited)	-
B6			
B7			
B8	B9		
to			
C0	C1	Cooling manipulated value (MV)	R
C2	C3	Cooling manipulated value (MV) (0 to 4000)	
C4	C5	Cooling transistor output flag	
CF		Cooling method setting	R/W
D0	E0	Cooling proportional band (Pc) setting	
D1	E1	Cooling upper output limiter	
D2	E2	Cooling control output cycle setting	
D3	E3	Overlap/dead band	

☒ Point

Default values for A series modules and Q series modules may be different.
 To apply an A series program using a default value to a Q series module, review the program.
 For details, refer to the user's manual for the Q series module used.

Q64TCTN, Q64TCRTN, Q64TCTBWN, Q64TCRTBWN			
Address (hexadecimal)		Name	Read/write
CH1	CH2		
3E	5E	E ² PROM's PID constants read instruction	R/W
3F	5F	Automatic backup setting after auto tuning of PID constants	
A0		System area (Use prohibited)	-
A1			
A2			
A3			
A4		Alert dead band setting	R/W
A5		Number of alert delay	
A6		Heater disconnection/output off-time current error detection delay count	
A7		Temperature rise completion range setting	
A8		Temperature rise completion soak time setting	
A9		PID continuation flag	
AA		Heater disconnection correction function selection	
AB	AC	System area (Use prohibited)	
AF		Transistor output monitor ON delay time setting	R/W
B0		CT monitor method switching	
B1	B2	Manipulated value of heating (MVh) for output with another analog module	R
B5		Resolution of the manipulated value for output with another analog module	-
B6		Cold junction temperature compensation selection	R/W
B7		Control switching monitor	R
B8	B9	Auto tuning mode selection	R/W
BC to BF		System area (Use prohibited)	-
C0	D0	Alert 1 mode setting	R/W
C1	D1	Alert 2 mode setting	
C2	D2	Alert 3 mode setting	
C3	D3	Alert 4 mode setting	
to			
100 to 107		Heater current process value	R
108 to 10F		CT input channel assignment setting	R/W
110 to 117		CT selection	
118 to 11F		Reference heater current value	
to			
2B8	2B9	Temperature conversion setting	R/W
to			
2C0	2C1	Manipulated value for cooling (MVc)	R
to			
2C4	2C5	Manipulated value of cooling (MVc) for output with another analog module	R
to			
2C8	2C9	Cooling transistor output flag	R
to			
2CF		Cooling method setting	R/W
2D0	2E0	Cooling proportional band (Pc) setting	
2D1	2E1	Cooling upper limit output limiter	
2D2	2E2	Cooling control output cycle setting	
2D3	2E3	Overlap/dead band setting	

7 HIGH-SPEED COUNTER MODULE REPLACEMENT

7.1 List of High-Speed Counter Module Alternative Models for Replacement

AnS/QnAS series		Transition to Q series	
Product	Model	Model	Remarks (Restrictions)
High-speed counter module	A1SD61	QD62	1) External wiring : Terminal block wiring → Connector wiring Cable size is changed. 2) Number of slots : Not changed 3) Counting speed : Can be switched (200KPPS, 100KPPS, or 10KPPS). 4) Counting range : 32-bit signed binary (-2147483648 to 2147483647) Program does not need to be reviewed. 5) Program : The number of occupied I/O points, I/O signals, and buffer memory addresses are changed. 6) Performance specifications: Not changed 7) Function specifications: Limit switch output function → Coincidence output function (Two coincidence detection output points can be set.)
		QD62-H01*1	1) External wiring : Terminal block wiring → Connector wiring Cable size is changed. 2) Number of slots : Not changed 3) Counting speed : Changed (50KPPS) 4) Counting range : 32-bit signed binary (-2147483648 to 2147483647) Program does not need to be reviewed. 5) Program : The number of occupied I/O points, I/O signals and buffer memory addresses are changed. 6) Performance specifications: Not changed 7) Function specifications: Limit switch output function → Coincidence output function (Two coincidence detection output points can be set.)
		QD62-H02*1	1) External wiring : Terminal block wiring → Connector wiring Cable size is changed. 2) Number of slots : Not changed 3) Counting speed : Changed (1-phase input: 10KPPS, 2-phase input: 7KPPS) 4) Counting range : 32-bit signed binary (-2147483648 to 2147483647) Program does not need to be reviewed. 5) Program : The number of occupied I/O points, I/O signals and buffer memory addresses are changed. 6) Performance specifications: Not changed 7) Function specifications: Limit switch output function → Coincidence output function (Two coincidence detection output points can be set.)
	A1SD62	QD62	1) External wiring : Terminal block wiring → Connector wiring Cable size is changed. 2) Number of slots : Not changed 3) Counting speed : Can be switched (200KPPS, 100KPPS, or 10KPPS). 4) Counting range : 24-bit binary (0 to 16777215) → 32-bit signed binary (-2147483648 to 2147483647) Program needs to be reviewed. 5) Program : The number of occupied I/O points, I/O signals and buffer memory addresses are changed. 6) Performance specifications: Not changed 7) Function specifications: Not changed

AnS/QnAS series		Transition to Q series	
Product	Model	Model	Remarks (Restrictions)
High-speed counter module	A1SD62E	QD62E	1) External wiring : Terminal block wiring → Connector wiring Cable size is changed. 2) Number of slots : Not changed 3) Counting speed : Can be switched (200KPPS, 100KPPS, or 10KPPS). 4) Counting range : 24-bit binary (0 to 16777215) → 32-bit signed binary (-2147483648 to 2147483647) Program needs to be reviewed. 5) Program : The number of occupied I/O points, I/O signals and buffer memory addresses are changed. 6) Performance specifications: Not changed 7) Function specifications: Not changed
	A1SD62D, A1SD62D-S1	QD62D	1) External wiring : Terminal block wiring → Connector wiring Cable size is changed. 2) Number of slots : Not changed 3) Counting speed : Can be switched (500KPPS, 200KPPS, 100KPPS, or 10KPPS). 4) Counting range : 24-bit binary (0 to 16777215) → 32-bit signed binary (-2147483648 to 2147483647) Program needs to be reviewed. 5) Program : The number of occupied I/O points, I/O signals and buffer memory addresses are changed. 6) Performance specifications: Not changed 7) Function specifications: Not changed

*1 An input filter system of the QD62-H01 and QD62-H02 is the same as that of A/AnS series high-speed counter modules. For this reason, modules can be replaced without considering the specifications of the existing pulse generator such as an encoder.

When replacing the A1SD61, select a module based on the specifications such as the counting speed.

☒ Point

1) Module replacement

A pulse generator, such as an encoder, that is connected to an AnS series module can be connected to a Q series module. Check the operation of the device before actually used in the system because the operating environment (the external wiring method) differs.

2) Counting range of the counter

Counting range differs between AnS series modules and Q series modules.

To change the counting range so that the ranges will be the same in the modules before and after the replacement, program needs to be reviewed.

A1SD62(E/D/D-S1): 0 to 16, 777, 215 (24-bit unsigned binary)

A1SD61, QD62(E/D), QD62-H01/H02: -2,147,483,648 to 2,147,483,647(32-bit signed binary)

3) Wiring

An external wiring method differs between AnS series modules and Q series modules.

A1SD61, A1SD62 (E/D/D-S1): Wiring using a terminal block

QD62(E/D), QD62-H01/H02: Wiring using a connector

In module replacement, continuous use of the I/O signal wire with solderless terminal which has been used for the A1S61 or A1SD62 (E/D/D-S1) requires the change of the external wiring method as in (a) (b).

(a) Using the upgrade tool (a conversion adaptor)

The existing wiring for A1S61 and A1SD62 (E/D/D-S1) can be connected directly to the Q series modules using the upgrade tool (conversion adaptor) manufactured by Mitsubishi Electric Engineering Co., Ltd.

Product	MELSEC-AnS/QnAS series module	MELSEC-Q series module	Conversion adaptor
High-speed counter module	A1SD61	QD62	ERNT-ASQTD61 ^{*1}
		QD62-H01	
		QD62-H02	
	A1SD62	QD62	ERNT-ASQTD62 ^{*1}
	A1SD62E	QD62E	
	A1SD62D	QD62D	

*1 Conversion adapter with fixture. Before using the conversion adapter with fixture, be sure to fasten its fixture to the base adapter or DIN rail mounting bracket using screws.

(b) Using the connector/terminal block converter module

Used for replacement when the Q series large type base unit and the conversion adapters manufactured by Mitsubishi Electric Engineering Co., Ltd. cannot be used due to the restrictions such as a system configuration and an installation location.

I/O cables with solderless terminal of the existing module can be continuously used without being aware of the existing wire size by rewiring the I/O cables with solderless terminal to the connector/terminal block converter module and connecting them by dedicated cables. This method, therefore, is helpful when there is not a sufficient space. The following figure shows the wiring method for using the connector/terminal block converter module.

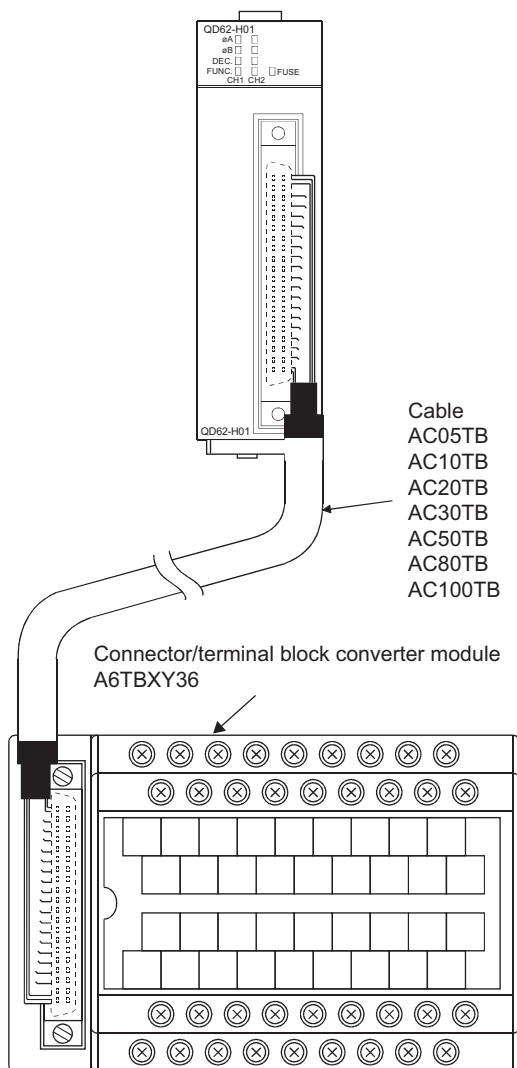

Signal name	Terminal number on connector side	Terminal symbol on terminal block side
A phase pulse input 24V	A20	10
A phase pulse input 12V	B20	0
A phase pulse input 5V	A19	11
ABCOM	B19	1
B phase pulse input 24V	A18	12
B phase pulse input 12V	B18	2
B phase pulse input 5V	A17	13
CH1 Preset input 24V	B17	3
CH1 Preset input 12V	A16	14
CH1 Preset input 5V	B16	4
CH1 CTRLCOM	A15	15
CH1 Function start 24V	B15	5
CH1 Function start 12V	A14	16
CH1 Function start 5V	B14	6
CH1 EQU (coincidence output point No.1)	A06	1E
CH1 EQU (coincidence output point No.2)	B06	E
A phase pulse input 24V	A13	17
A phase pulse input 12V	B13	7
A phase pulse input 5V	A12	18
ABCOM	B12	8
B phase pulse input 24V	A11	19
B phase pulse input 12V	B11	9
B phase pulse input 5V	A10	1A
CH2 Preset input 24V	B10	A
CH2 Preset input 12V	A09	1B
CH2 Preset input 5V	B09	B
CH2 CTRLCOM	A08	1C
CH2 Function start 24V	B08	C
CH2 Function start 12V	A07	1D
CH2 Function start 5V	B07	D
CH2 EQU (coincidence output point No.1)	A05	1F
CH2 EQU (coincidence output point No.2)	B05	F
12/24V	B02	24V
	B01	
0V	A02	0V
	A01	

7.2 A1SD61

7.2.1 Performance specifications comparison

(1) Comparison between A1SD61 and QD62

○: Compatible, △: Partial change required, ×: Incompatible

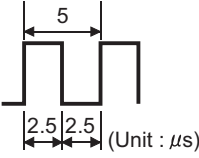
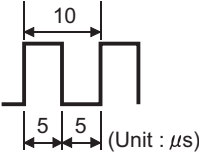
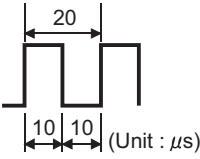
Item		A1SD61		QD62			Compat- ibility	Precautions for replacement	
Number of occupied I/O points		32 points (I/O assignment: special 32 points)		16 points (I/O assignment: intelligent 16 points)			△	*1	
Number of channels		1 channel		2 channels			○		
Counting speed switch settings		50K	10K	200K (100K to 200KPPS)	100K (10K to 100KPPS)	10K (10KPPS or less)	○	Set the counting speed of the QD62 with the intelligent function module switch setting of GX Developer.	
Count input signal	Phase	1-phase input, 2-phase input					○		
	Signal level (φA, φB)	5VDC 12VDC 24VDC } 2 to 5mA					○	*2	
Performance specifications of 1 channel Counter	Counting speed (Max.)	1-phase input	50KPPS	10KPPS	200KPPS	100KPPS	10KPPS	○	
		2-phase input	50KPPS	7KPPS	200KPPS	100KPPS	10KPPS		
	Counting range	32-bit signed binary (-2147483648 to 2147483647)					○		
	Type	UP/DOWN preset counter + ring counter function					○		
	Minimum count pulse width, Duty ratio: 50%							-	
	(200KPPS)	-			 (Minimum phase difference in 2-phase input: 1.25μs)		○		
	(100KPPS)	-			 (Minimum phase difference in 2-phase input: 2.5μs)		○		
	(50KPPS)	 (1-phase and 2-phase input)		-			△	Set the counting speed of the QD62 to "100K".	

○: Compatible, △: Partial change required, ×: Incompatible

Item		A1SD61		QD62		Compat- ibility	Precautions for replacement	
(Counting speed switch setting)		50KPPS	10KPPS	200KPPS	100KPPS	10KPPS	-	
Performance specifications of 1 channel	Counter	Minimum count pulse width, Duty ratio: 50%					-	
		(10KPPS) 1-phase input	 (Unit : µs) (1-phase input)		 (Unit : µs)		○	
		(10KPPS) 2-phase input	 (Unit : µs) (2-phase input)		(Minimum phase difference in 2-phase input: 25µs)			
	Magnitude comparison between CPU and high-speed counter module	Comparison range	32-bit signed binary		○			
		Comparison result	a contact: Dog ON address ≤ Count value ≤ Dog OFF address b contact Dog OFF address ≤ Count value ≤ Dog ON address	Set value < count value Set value = count value Set value > count value		△	Two points can be set.	
	External input	Preset					△	Since the external input specifications differ, check the specifications of external device.
		Function start	12/24VDC, 3/6mA 5VDC, 5mA	5/12/24VDC, 2 to 5mA				
	External output	Coincidence output	-		Transistor (sink type) output 2 points/channel 12/24VDC, 0.5A/point, 2A/common		△	Output currents differ.
		Limit switch output	Transistor (open collector) output 12/24VDC, 0.1A/point, 0.8A/common		-			
	Internal current consumption (5VDC)		0.35A		0.30A		○	
Weight		0.27kg		0.11kg		△		

*1 A program used before replacement can be utilized by setting the start I/O signal numbers of the modules mounted to the right of the QD62 so that they can be the same as that of the module before replacement.
(Set the start number at "Start XY" of the I/O assignment tab. The number of occupied points of the QD62 cannot be changed.)

*2 The rise/fall time of a pulse affects the counting speed. Countable counting speeds are as follows.
Counting a pulse greater than $t = 50\mu\text{s}$ may result in a miscount.
(For the QD62)

Rise/fall time	Common to 1-phase input and 2-phase input		
Counter speed switch setting	200K	100K	10K
$t = 1.25\mu\text{s}$ or less	200KPPS	100KPPS	10KPPS
$t = 2.5\mu\text{s}$ or less	100KPPS	100KPPS	10KPPS
$t = 25\mu\text{s}$ or less	-	10KPPS	10KPPS
$t = 500\mu\text{s}$	-	-	500KPPS

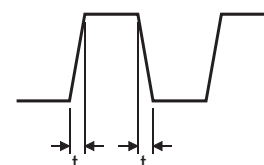

(2) Comparison between A1SD61 and QD62-H01

○: Compatible, △: Partial change required, ×: Incompatible

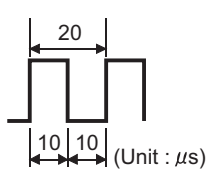
Item		A1SD61		QD62-H01		Compat- ibility	Precautions for replacement			
Number of occupied I/O points		32 points (I/O assignment: special 32 points)		16 points (I/O assignment: intelligent 16 points)		△	*1			
Number of channels		1 channel		2 channels		○				
Counting speed switch settings		50K	10K	50K		○	Set "2 (counting speed 200KPPS)" in the intelligent function module switch setting. Counting is performed using 50KPPS by setting "2 (counting speed 200KPPS)."			
Performance specifications of 1 channel	Count input signal	Phase		1-phase input, 2-phase input		○				
		Signal level (φA, φB)		5VDC 12VDC 24VDC } 2 to 5mA		○				
	Counter	Counting speed (Max.)		1-phase input	50KPPS	10KPPS	1-phase input	50KPPS	○	*2
				2-phase input	50KPPS	7KPPS	2-phase input	50KPPS		
		Counting range		32-bit signed binary (-2147483648 to 2147483647)				○		
		Type		UP/DOWN preset counter + ring counter function				○		
		Minimum count pulse width, Duty ratio: 50%						-		
	Minimum count pulse width		 <p>(Unit : μs)</p> <p>(1-phase and 2-phase input) Set input rise time to 5μs or less.</p>				○			
	Magnitude comparison between CPU and A1SD61/QD62-H01	Comparison range		32-bit signed binary				○		
		Comparison result		a contact: Dog ON address ≤ Count value ≤ Dog OFF address b contact Dog OFF address ≤ Count value ≤ Dog ON address		Set value < count value Set value = count value Set value > count value		○		
External input	Preset						Since the external input specifications differ, check the specifications of external device.			
	Function start	12/24VDC, 3/6mA 5VDC, 5mA		5/12/24VDC, 2 to 5mA		△				
External output	Coincidence output	-		Transistor (sink type) output 2 points/channel 12/24VDC, 0.5A/point, 2A/common		△	Output currents differ.			
	Limit switch output	Transistor (open collector) output 12/24VDC, 0.1A/point, 0.8A/common		-						
Internal current consumption (5VDC)		0.35A		0.30A		○				
Weight		0.27kg		0.11kg		△				

- *1 A program used before replacement can be utilized by setting the start I/O signal numbers of the modules mounted to the right of the QD62-H01 so that they can be the same as that of the module before replacement.
(Set the start number at "Start XY" of the I/O assignment tab. The number of occupied points of the QD62-H01 cannot be changed.)
- *2 The rise/fall time of a pulse affects the counting speed. Countable counting speeds are as follows.
Counting a pulse greater than $t = 50\mu\text{s}$ may result in a miscount.
(For the QD62-H1)

Rise/fall time	Common to 1-phase input and 2-phase input
$t = 5\mu\text{s}$	50KPPS
$t = 50\mu\text{s}$	5KPPS

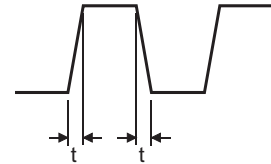

(3) Comparison between A1SD61 and QD62-H02

○: Compatible, △: Partial change required, ×: Incompatible

Item		A1SD61		QD62-H02		Compat- ibility	Precautions for replacement		
Number of occupied I/O points		32 points (I/O assignment: special 32 points)		16 points (I/O assignment: intelligent 16 points)		△	*1		
Number of channels		1 channel		2 channels		○			
Counting speed switch settings		50K	10K	10K		○	Set "2 (counting speed 200KPPS)" in the intelligent function module switch setting. Counting is performed using 10KPPS by setting "2 (counting speed 200KPPS)."		
Performance specifications of 1 channel	Count input signal	Phase	1-phase input, 2-phase input				○		
		Signal level (φA, φB)	5VDC 12VDC } 2 to 5mA 24VDC				○		
	Counter	Counting speed (Max.)	1-phase input	50KPPS	10KPPS	1-phase input	10KPPS	○	*2
			2-phase input	50KPPS	7KPPS	2-phase input	7KPPS		
		Counting range	32-bit signed binary (-2147483648 to 2147483647)				○		
		Type	UP/DOWN preset counter + ring counter function				○		
		Minimum count pulse width, Duty ratio: 50%				-			
		Minimum count pulse width	<p style="text-align: center;">Set input rise time to 5µs or less.</p>				○		
	Magnitude comparison between CPU and A1SD61/QD62-H02	Comparison range	32-bit signed binary				○		
		Comparison result	a contact: Dog ON address ≤ Count value ≤ Dog OFF address b contact Dog OFF address ≤ Count value ≤ Dog ON address		Set value < count value Set value = count value Set value > count value		△	Two points can be set.	
External input	Preset								
	Function start	12/24VDC, 3/6mA 5VDC, 5mA		5/12/24VDC, 2 to 5mA		△	Since the external input specifications differ, check the specifications of external device.		
External output	Coincidence output	-		Transistor (sink type) output 2 points/channel 12/24VDC, 0.5A/point, 2A/common		△	Output currents differ.		
	Limit switch output	Transistor (open collector) output 12/24VDC, 0.1A/point, 0.8A/common		-					
Internal current consumption (5VDC)		0.35A		0.30A		○			
Weight		0.27kg		0.11kg		△			

- *1 A program used before replacement can be utilized by setting the start I/O signal numbers of the modules mounted to the right of the QD62-H02 so that they can be the same as that of the module before replacement.
(Set the start number at "Start XY" of the I/O assignment tab. The number of occupied points of the QD62-H02 cannot be changed.)
- *2 The rise/fall time of a pulse affects the counting speed. Countable counting speeds are as follows.
Counting a pulse greater than $t = 50\mu\text{s}$ may result in a miscount.
(For the QD62-H02)

Rise/fall time	1-phase input	2-phase input
$t = 5\mu\text{s}$	10KPPS	7KPPS
$t = 500\mu\text{s}$	500PPS	250PPS

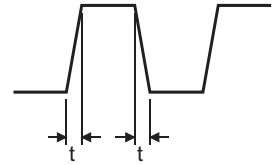

7.2.2 Functional comparison

○: Available, -: Not available

Item	Description	A1SD61	QD62		Precautions for replacement
			QD62-H01	QD62-H02	
Preset function	Changes the counter present value to a specified value.	○	○		
Disable function	Terminates counting.	○	○		
Ring counter function	Repeatedly executes counting between user's setting values.	○	○		For Q series modules, values are set with the intelligent function module switch setting of GX Developer.
Linear counter function	If the count exceeds the range, this function detects an overflow.	-	○		
Coincidence output function	Outputs a signal when the counter present value matches the preset value.	-	○		No.1 and No.2 coincidence output points can be set for each channel.
Limit switch output function	Outputs the ON/OFF signal when the present value of the limit switch output command counter matches the output status preset to a channel.	○	-		Use the coincidence output function instead. Note that the specifications (such as set point) are different.
Coincidence detection interrupt function	Generates an interrupt signal to the programmable controller CPU when coincidence is detected.	-	○		
Latch counter function	Latches the present value at the time a signal is input.	○	○		
Sampling counter function	Counts the pulse that was input during the sampling time set.	○	○		
Periodic pulse counter function	The function allows storing the present value in the periodic pulse count present value and the previous value in the periodic pulse count previous value for each period time set.	○	○		

7.2.3 I/O signal comparison

Sequence program change is required as the I/O signals differ.

For details of the I/O signals or sequence program, refer to the High-Speed Counter Module User's Manual.

A1SD61				QD62, QD62-H01, QD62-H02			
Device No.	Signal name	Device No.	Signal name	Device No.	Signal name	Device No.	Signal name
X0	Watchdog timer error flag	Y0	Use prohibited	X0	Module ready	Y0	CH1 Coincidence signal No.1 reset command
X1	CH1 limit switch output status flag	Y1		X1	CH1 Counter value large (point No.1)	Y1	CH1 Preset command
X2	CH2 limit switch output status flag	Y2		X2	CH1 Counter value coincidence (point No.1)	Y2	CH1 Coincidence signal enable command
X3	CH3 limit switch output status flag	Y3		X3	CH1 Counter value small (point No.1)	Y3	CH1 Down count command
X4	CH4 limit switch output status flag	Y4		X4	CH1 External preset request detection	Y4	CH1 Count enable command
X5	CH5 limit switch output status flag	Y5		X5	CH1 Counter value large (point No.2)	Y5	CH1 External preset detection reset command
X6	CH6 limit switch output status flag	Y6		X6	CH1 Counter value coincidence (point No.2)	Y6	CH1 Counter function selection start command
X7	CH7 limit switch output status flag	Y7		X7	CH1 Counter value small (point No.2)	Y7	CH1 Coincidence signal No.2 reset command
X8	CH8 limit switch output status flag	Y8		X8	CH2 Counter value large (point No.1)	Y8	CH2 Coincidence signal No.1 reset command
X9	Limit switch output enable flag	Y9		X9	CH2 Counter value coincidence (point No.1)	Y9	CH2 Preset command
XA	External preset command detection flag	YA		XA	CH2 Counter value small (point No.1)	YA	CH2 Coincidence signal enable command
XB	Error flag	YB		XB	CH2 External preset request detection	YB	CH2 Down count command
XC	Fuse/external power cutoff detection flag	YC		XC	CH2 Counter value large (point No.2)	YC	CH2 Count enable command
XD	Sampling/periodic counter flag	YD		XD	CH2 Counter value coincidence (point No.2)	YD	CH2 External preset detection reset command
XE	Use prohibited	YE		XE	CH2 Counter value small (point No.2)	YE	CH2 Counter function selection start command
XF		YF		XF	Fuse broken detection flag	YF	CH2 Coincidence signal No.2 reset command
X10		Y10		Count enable command			
X11		Y11		Decrement count command			
X12		Y12	Preset command				
X13		Y13	Ring counter command				
X14		Y14	Counter function selection start command				
X15		Y15	Limit switch output command				
X16		Y16	External preset command detection reset command				
X17		Y17	Error reset command				

A1SD61			
Device No.	Signal name	Device No.	Signal name
X18	Use prohibited	Y18	Use prohibited
X19		Y19	
X1A		Y1A	
X1B		Y1B	
X1C		Y1C	
X1D		Y1D	
X1E		Y1E	
X1F		Y1F	

7.2.4 Buffer memory address comparison

Sequence program change is required as the assignment of buffer memory differs.

For details of the buffer memory or sequence program, refer to the High-Speed Counter Module User's Manual.

A1SD61			QD62, QD62-H01, QD62-H02									
Address (decimal)	Name	Read/write	Address (decimal)		Name	Read/write						
			CH1	CH2								
0	Present value	(L)	0	32	Preset value setting	(L)	R/W					
1		(H)	1	33		(H)						
2	Counter function selection count value	(L)	2	34	Present value	(L)	R					
3		(H)	3	35		(H)						
4	Pulse input mode setting	R/W	4	36	Coincidence output point set No.1	(L)	R/W					
5	Counter function selection setting		5	37		(H)						
6	Preset value setting		(L)	6	38	Coincidence output point set No.2	(L)	R/W				
7			(H)	7	39		(H)					
8	Ring counter value setting		(L)	8	40	Overflow detection flag		R				
9			(H)	9	41	Counter function selection setting		R/W				
10	Sampling/periodic time setting		10	42	Sampling/periodic setting		R/W					
11	Write data error code		11	43	Sampling/periodic counter flag		R/W					
12 to 28	CH1 limit switch output data setting		R/W	12	44	Latch count value	(L)	R				
					13		45		(H)			
29 to 45	CH2 limit switch output data setting			14	46	Sampling count value	(L)		R			
					15		47			(H)		
46 to 62	CH3 limit switch output data setting	16		48	Periodic pulse count previous value	(L)	R					
				17		49				(H)		
63 to 79	CH4 limit switch output data setting	18		50	Periodic pulse count present value	(L)				R		
				19		51					(H)	
80 to 96	CH5 limit switch output data setting	20		52	Ring counter minimum value	(L)					R/W	
				21		53						(H)
97 to 113	CH6 limit switch output data setting	22		54	Ring counter maximum value	(L)						R/W
				23		55						
114 to 130	CH7 limit switch output data setting	24 to 31	56 to 63	System area (Use prohibited)		-						
131 to 147		CH8 limit switch output data setting										

7.3 A1SD62(E/D/D-S1)

7.3.1 Performance specifications comparison

(1) Comparison between A1SD62 and QD62

○: Compatible, △: Partial change required, ×: Incompatible

Item		A1SD62		QD62			Compat- ibility	Precautions for replacement		
Number of occupied I/O points		32 points (I/O assignment: special 32 points)		16 points (I/O assignment: intelligent 16 points)			△	The number of occupied I/O points has changed to 16 points.		
Number of channels		2 channels					○			
Counting speed switch settings		100K	10K	200K (100K to 200KPPS)	100K (10K to 100KPPS)	10K (10KPPS or less)	○	Set the counting speed of the QD62 with the intelligent function module switch setting of GX Developer.		
Performance specifications of 1 channel	Count input signal	Phase		1-phase input, 2-phase input			○			
		Signal level (φA, φB)		5VDC 12VDC 24VDC } 2 to 5mA			○			
	Counter	Counting speed (Max.)	1-phase input	100KPPS	10KPPS	200KPPS	100KPPS	10KPPS	○	
			2-phase input	100KPPS	7KPPS	200KPPS	100KPPS	10KPPS		
	Counter	Counting range	24-bit unsigned binary (0 to 16,777,215)		32-bit signed binary (-2147483648 to 2147483647)			△	Since the QD62 uses 32-bit signed binary values, sequence program needs to be changed.	
Counter	Type	UP/DOWN preset counter + ring counter function					○			

○: Compatible, △: Partial change required, ×: Incompatible

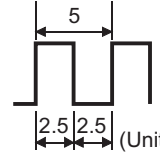
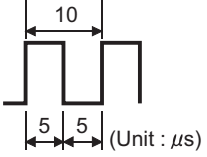
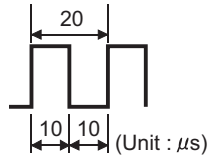
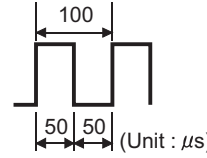
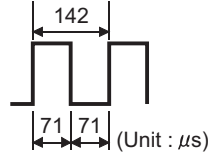
Item		A1SD62	QD62	Compat- ibility	Precautions for replacement
Performance specifications of 1 channel Counter	Minimum count pulse width, Duty ratio: 50%			-	
	(200KPPS)	-	 <p>(Unit : μs) (Minimum phase difference in 2-phase input: 1.25μs)</p>	○	
	(100KPPS)	 <p>(Unit : μs) (Minimum phase difference in 2-phase input: 2.5μs)</p>			
	(10KPPS) 1-phase input	 <p>(Unit : μs) (1-phase input)</p>	 <p>(Unit : μs) (Minimum phase difference in 2-phase input: 25μs)</p>		
	(10KPPS) 2-phase input	 <p>(Unit : μs) (2-phase input)</p>			
Magnitude comparison between CPU and high- speed counter module	Comparison range	24-bit unsigned binary	32-bit signed binary	○	
	Comparison result	Set value < count value Set value = count value Set value > count value		○	
External input	Preset	5/12/24VDC, 2 to 5mA		○	
	Function start	5/12/24VDC, 2 to 5mA		○	
External output	Coincidence output	Transistor (sink type) output 12/24VDC, 0.5A/point, 2A/common		○	
		1 point/channel	2 points/channel		
Internal current consumption (5VDC)		0.1A	0.3A	△	Recalculation of internal current consumption (5VDC) is required.
Weight		0.25kg	0.11kg	△	

(2) Comparison between A1SD62E and QD62E

○: Compatible, △: Partial change required, ×: Incompatible

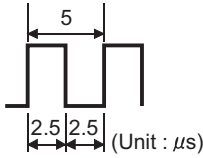
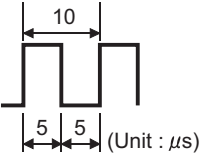
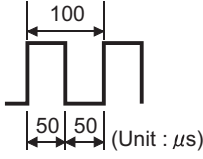
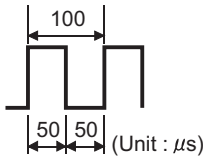
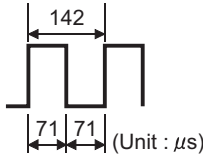
Item		A1SD62E		QD62E			Compat- ibility	Precautions for replacement	
Number of occupied I/O points		32 points (I/O assignment: special 32 points)		16 points (I/O assignment: intelligent 16 points)			△	The number of occupied I/O points has changed to 16 points.	
Number of channels		2 channels						○	
Counting speed switch settings		100K	10K	200K (100K to 200KPPS)	100K (10K to 100KPPS)	10K (10KPPS or less)	○	Set the counting speed of the QD62E with the intelligent function module switch setting of GX Developer.	
Count input signal	Phase	1-phase input, 2-phase input						○	
	Signal level (φA, φB)	5VDC 12VDC 24VDC } 2 to 5mA						○	
Performance specifications of 1 channel Counter	Counting speed (Max.)	1-phase input	100KPPS	10KPPS	200KPPS	100KPPS	10KPPS	○	
		2-phase input	100KPPS	7KPPS	200KPPS	100KPPS	10KPPS		
	Counting range	24-bit unsigned binary (0 to 16,777,215)			32-bit signed binary (-2147483648 to 2147483647)			△	Since the QD62E uses 32-bit signed binary values, sequence program needs to be changed.
	Type	UP/DOWN preset counter + ring counter function						○	
	Minimum count pulse width, Duty ratio: 50%							-	
	(200KPPS)	-			 (Unit : μs) (Minimum phase difference in 2-phase input: 1.25μs)			○	
(100KPPS)	 (Unit : μs) (Minimum phase difference in 2-phase input: 2.5μs)								
(10KPPS) 1-phase input	 (Unit : μs) (1-phase input)			 (Unit : μs) (Minimum phase difference in 2-phase input: 25μs)					
(10KPPS) 2-phase input	 (Unit : μs) (2-phase input)								

○: Compatible, △: Partial change required, ×: Incompatible

Item			A1SD62E	QD62E	Compat- ibility	Precautions for replacement	
Performance specifications of 1 channel	Magnitude comparison between CPU and high-speed counter module	Comparison range	24-bit unsigned binary	32-bit signed binary	○		
		Comparison result	Set value < count value Set value = count value Set value > count value		○		
	External input	Preset	5/12/24VDC, 2 to 5mA		○		
		Function start	5/12/24VDC, 2 to 5mA		○		
	External output	Coincidence output	Transistor (source type) output 12/24VDC, 0.1A/point, 0.4A/common		○		
			1 point/channel	2 points/channel			
	Internal current consumption (5VDC)			0.1A	0.33A	△	Recalculation of internal current consumption (5VDC) is required.
	Weight			0.25kg	0.11kg	△	

(3) Comparison between A1SD62D and QD62D

○: Compatible, △: Partial change required, ×: Incompatible

Item		A1SD62D		QD62D				Compat- ibility	Precautions for replacement	
Number of occupied I/O points		32 points (I/O assignment: special 32 points)		16 points (I/O assignment: intelligent 16 points)				△	The number of occupied I/O points has changed to 16 points.	
Number of channels		2 channels						○		
Counting speed switch settings		200K	10K	500K (200K to 500KPPS)	200K (100K to 200KPPS)	100K (10K to 100KPPS)	10K (10KPPS or less)	○	Set the counting speed of the QD62D with the intelligent function module switch setting of GX Developer.	
Performance specifications of 1 channel	Count input signal	Phase		1-phase input, 2-phase input				○		
		Signal level (φA, φB)		EIA Standard RS-422-A Differential line driver level (AM26LS31 [manufactured by Texas Instruments] or equivalent)				○		
	Counting speed (Max.)	1-phase input	200KPPS	10KPPS	500KPPS	200KPPS	100KPPS	10KPPS	○	
		2-phase input	200KPPS	7KPPS						
	Counting range	24-bit unsigned binary (0 to 16,777,215)		32-bit signed binary (-2147483648 to 2147483647)				△	Since the QD62D uses 32-bit signed binary values, sequence program needs to be changed.	
	Type	UP/DOWN preset counter + ring counter function						○		
	Minimum count pulse width, Duty ratio: 50%								-	
	Counter	(500KPPS)	-		<p>(Minimum phase difference in 2-phase input: 0.5μs)</p>				○	
		(200KPPS)	-		<p>(Minimum phase difference in 2-phase input: 1.25μs)</p>					
		(100KPPS)	-		<p>(Minimum phase difference in 2-phase input: 2.5μs)</p>					

○: Compatible, △: Partial change required, ✕: Incompatible

Item		A1SD62D		QD62D			Compat- ibility	Precautions for replacement	
		200K	10K	500K	200K	100K			10K
(Counting speed switch settings)		200K	10K	500K	200K	100K	10K	-	
Performance specifications of 1 channel	Counter	Minimum count pulse width, Duty ratio: 50%						-	
		(10KPPS) 1-phase input	 (Unit : µs) (1-phase input)		 (Unit : µs)			○	
		(10KPPS) 2-phase input	 (Unit : µs) (1-phase input)		(Minimum phase difference in 2-phase input: 25µs)				
	Magnitude comparison between CPU and high-speed counter module	Comparison range	24-bit unsigned binary		32-bit signed binary			○	
		Comparison result	Set value < count value Set value = count value Set value > count value				○		
	External input	Preset	5/12/24VDC, 2 to 5mA		DC input: 5/12/24VDC, 2 to 5mA Differential input: EIA Standard RS-422- A, Differential line driver may be connected.			○	The QD62D supports both DC input and differential input.
		Function start							
	External output	Coincidence output	Transistor (sink type) output 12/24VDC, 0.5A/point, 2A/common				○		
			1 point/channel		2 points/channel				
	Internal current consumption (5VDC)		0.25A		0.38A			△	Recalculation of internal current consumption (5VDC) is required.
Weight		0.25kg		0.12kg			△		

(4) Comparison between A1SD62D-S1 and QD62D

○: Compatible, △: Partial change required, ×: Incompatible

Item		A1SD62D-S1		QD62D				Compat- ibility	Precautions for replacement	
Number of occupied I/O points		32 points (I/O assignment: special 32 points)		16 points (I/O assignment: intelligent 16 points)				△	The number of occupied I/O points has changed to 16 points.	
Number of channels		2 channels						○		
Counting speed switch settings		200K	10K	500K (200K to 500KPPS)	200K (100K to 200KPPS)	100K (10K to 100KPPS)	10K (10KPPS or less)	○	Set the counting speed of the QD62D with the intelligent function module switch setting of GX Developer.	
Performance specifications of 1 channel	Count input signal	Phase		1-phase input, 2-phase input				○		
		Signal level (φA, φB)		EIA Standard RS-422-A Differential line driver level (AM26LS31 [manufactured by Texas Instruments] or equivalent)				○		
	Counting speed (Max.)	1-phase input	200KPPS	10KPPS	500KPPS	200KPPS	100KPPS	10KPPS	○	
		2-phase input	200KPPS	7KPPS						
	Counting range	24-bit unsigned binary (0 to 16,777,215)		32-bit signed binary (-2147483648 to 2147483647)				△	Since the QD62D uses 32-bit signed binary values, sequence program needs to be changed.	
	Type	UP/DOWN preset counter + ring counter function						○		
	Minimum count pulse width, Duty ratio: 50%								-	
	Counter	(500KPPS)			<p>(Minimum phase difference in 2-phase input: 0.5μs)</p>				○	
		(200KPPS)			<p>(Minimum phase difference in 2-phase input: 1.25μs)</p>					
		(100KPPS)			<p>(Minimum phase difference in 2-phase input: 2.5μs)</p>					

○: Compatible, △: Partial change required, ✕: Incompatible

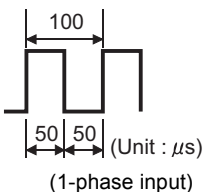
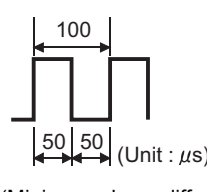
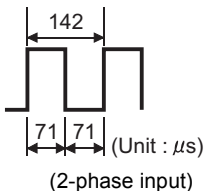
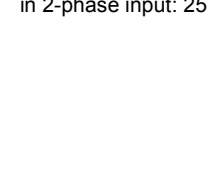
Item		A1SD62D-S1		QD62D			Compati- bility	Precautions for replacement		
(Counting speed switch settings)		200K	10K	500K	200K	100K	10K	-		
Performance specifications of 1 channel	Counter	Minimum count pulse width, Duty ratio: 50%							-	
		(10KPPS) 1-phase input	 <p>(1-phase input)</p>		 <p>(Unit : μs)</p>			○		
		(10KPPS) 2-phase input	 <p>(2-phase input)</p>		 <p>(Unit : μs)</p> <p>(Minimum phase difference in 2-phase input: 25μs)</p>					
	Magnitude comparison between CPU and high-speed counter module	Comparison range	24-bit unsigned binary		32-bit signed binary					○
		Comparison result	Set value < count value Set value = count value Set value > count value					○		
	External input	Preset	EIA Standard RS-422-A Differential line driver level (AM26LS31 or equivalent)		DC input: 5/12/24VDC, 2 to 5mA Differential input: EIA Standard RS-422- A. Differential line driver may be connected.			○	The QD62D supports both DC input and differential input.	
		Function start	5/12/24VDC, 2 to 5mA							
	External output	Coincidence output	Transistor (sink type) output 12/24VDC, 0.5A/point, 2A/common					○		
			1 point/channel		2 points/channel					
	Internal current consumption (5VDC)		0.25A		0.38A			△	Recalculation of internal current consumption (5VDC) is required.	
Weight		0.25kg		0.12kg			△			

7.3.2 Functional comparison

○: Available, -: Not available

Item	Description	A1SD62 (E/D/D-S1)	QD62(E/D)	Precautions for replacement
Preset function	Changes the counter present value to a specified value.	○	○	
Disable function	Terminates counting.	○	○	
Ring counter function	Repeatedly executes counting between user's setting values.	○	○	For the QD62(E/D), values are set with the intelligent function module switch setting of GX Developer.
Linear counter function	If the count exceeds the range, this function detects an overflow.	-	○	
Coincidence output function	Outputs a signal when the counter present value matches the preset value.	○	○	No.1 and No.2 coincidence output points can be set for each channel.
Coincidence detection interrupt function	Generates an interrupt signal to the programmable controller CPU when coincidence is detected.	-	○	
Latch counter function	Latches the present value at the time a signal is input.	○	○	
Sampling counter function	Counts the pulses that are input during the sampling time set.	○	○	
Periodic pulse counter function	The function allows storing the present value in the periodic pulse count present value and the previous value in the periodic pulse count previous value for each period time set.	○	○	

7.3.3 I/O signal comparison

Sequence program change is required as the I/O signals differ.

For details of the I/O signals or sequence program, refer to the High-Speed Counter Module User's Manual.

A1SD62(E/D/D-S1)				QD62(E/D)				
Device No.	Signal name	Device No.	Signal name	Device No.	Signal name	Device No.	Signal name	
X0	CH1 Counter value large (point No.1)	Y0	Use prohibited	X0	Module ready	Y0	CH1 Coincidence signal No.1 reset command	
X1	CH1 Counter value coincidence (point No.1)	Y1		X1	CH1 Counter value large (point No.1)	Y1	CH1 Preset command	
X2	CH1 Counter value small (point No.1)	Y2		X2	CH1 Counter value coincidence (point No.1)	Y2	CH1 Coincidence signal enable command	
X3	CH1 External preset request detection	Y3		X3	CH1 Counter value small (point No.1)	Y3	CH1 Down count command	
X4	CH2 Counter value large (point No.1)	Y4		X4	CH1 External preset request detection	Y4	CH1 Count enable command	
X5	CH2 Counter value coincidence (point No.1)	Y5		X5	CH1 Counter value large (point No.2)	Y5	CH1 External preset detection reset command	
X6	CH2 Counter value small (point No.1)	Y6		X6	CH1 Counter value coincidence (point No.2)	Y6	CH1 Counter function selection start command	
X7	CH2 External preset request detection	Y7		X7	CH1 Counter value small (point No.2)	Y7	CH1 Coincidence signal No.2 reset command	
X8 ^{*1}	CH1 Counter value large (point No.2)	Y8		X8	CH2 Counter value large (point No.1)	Y8	CH2 Coincidence signal No.1 reset command	
X9 ^{*1}	CH1 Counter value coincidence (point No.2)	Y9		X9	CH2 Counter value coincidence (point No.1)	Y9	CH2 Preset command	
XA ^{*1}	CH1 Counter value small (point No.2)	YA		XA	CH2 Counter value small (point No.1)	YA	CH2 Coincidence signal enable command	
XB ^{*1}	CH2 Counter value large (point No.2)	YB		XB	CH2 External preset request detection	YB	CH2 Down count command	
XC ^{*1}	CH2 Counter value coincidence (point No.2)	YC		XC	CH2 Counter value large (point No.2)	YC	CH2 Count enable command	
XD ^{*1}	CH2 Counter value small (point No.2)	YD		XD	CH2 Counter value coincidence (point No.2)	YD	CH2 External preset detection reset command	
XE	Fuse/external power cutoff detection flag	YE		XE	CH2 Counter value small (point No.2)	YE	CH2 Counter function selection start command	
XF		YF		XF	Fuse broken detection flag	YF	CH2 Coincidence signal No.2 reset command	
X10	Use prohibited	Y10		CH1 Coincidence signal reset command				
X11		Y11		CH1 Preset command				
X12		Y12		CH1 Coincidence signal enable command				
X13		Y13	CH1 Down count command					
X14		Y14	CH1 Count enable command					
X15		Y15	CH1 Count value read request					
X16		Y16	CH1 Count function selection start command					
X17		Y17	CH2 Coincidence signal reset command					
X18		Y18	CH2 Preset command					

A1SD62(E/D/D-S1)			
Device No.	Signal name	Device No.	Signal name
X19	Use prohibited	Y19	CH2 Coincidence signal enable command
X1A		Y1A	CH2 Down count command
X1B		Y1B	CH2 Count enable command
X1C		Y1C	CH2 Count value read request
X1D		Y1D	CH2 Count function selection start command
X1E		Y1E	Use prohibited
X1F		Y1F	

*1 These signals are use-prohibited in the A1SD62D-S1.

7.3.4 Buffer memory address comparison

Sequence program change is required as the assignment of buffer memory differs.

For details of the buffer memory or sequence program, refer to the High-Speed Counter Module User's Manual.

A1SD62(E/D/D-S1)					QD62(E/D)				
Address (decimal)		Name	Read/write	Address (decimal)		Name	Read/write		
CH1	CH2			CH1	CH2				
1	33	Preset value setting	(L) (H)	R/W	0	32	Preset value setting	(L) (H)	R/W
2	34				1	33			
3	35	Pulse input mode setting		R	2	34	Present value	(L) (H)	R
4	36	Present value			3	35			
5	37	Present value		R/W	4	36	Coincidence output point set No.1	(L) (H)	R/W
6	38	Coincidence output point setting No.1			5	37			
7	39	Coincidence output point setting No.1		R/W	6	38	Coincidence output point set No.2	(L) (H)	R/W
8	40	Counter function selection setting			7	39			
9	41	Sampling/periodic time setting		W	8	40	Overflow detection flag		R
10	42	External preset detection reset command			9	41	Counter function selection setting		R/W
11 ^{*1}	43 ^{*1}	Point No.2 coincidence signal reset command		R/W	10	42	Sampling/periodic setting		
12 ^{*1}	44 ^{*1}	Coincidence output point setting No.2			11	43	Sampling/periodic counter flag		
13 ^{*1}	45 ^{*1}	Coincidence output point setting No.2		R	12	44	Latch count value	(L) (H)	R
14	46	Latch count value			13	45	Latch count value		
15	47	Latch count value		R	14	46	Sampling count value		R
16	48	Sampling count value			15	47	Sampling count value		
17	49	Sampling count value		R	16	48	Periodic pulse count previous value		R
18	50	Periodic pulse count previous value			17	49	Periodic pulse count previous value		
19	51	Periodic pulse count previous value		R	18	50	Periodic pulse count present value		R
20	52	Periodic pulse count present value			19	51	Periodic pulse count present value		
21	53	Periodic pulse count present value		R/W	20	52	Ring counter minimum value		R/W
22	54	Sampling/periodic counter flag			21	53	Ring counter minimum value		
					22	54	Ring counter maximum value		
					23	55	Ring counter maximum value		
					24	56	System area (Use prohibited)		-
					to	to			
					31	63			

*1 These addresses are use-prohibited in the A1SD62D-S1.

8 POSITIONING MODULE REPLACEMENT

8.1 List of Positioning Module Alternative Models for Replacement

AnS series		Transition to Q series	
Product	Model	Model	Remarks (Restrictions)
Positioning module*3	A1SD70	QD73A1	1) External wiring : Not changed*2 (An external power supply (±15VDC) is not required. The connector installation direction is reverse.) 2) Number of slots : Not changed (Two slots are occupied.) 3) Program : Buffer memory assignment and change of the setting method 4) Performance specifications change: Upward-compatibility 5) Function specifications: Partly changed (LED indication and function setting method)
	A1SD75P1-S3	QD75P1N*1 (when an open collector is connected)	1) External wiring : Connector and wiring are changed. 2) Number of slots : Not changed 3) Program : I/O signals and buffer memory assignment are changed. The entire program is reviewed according to the specifications change. 4) Performance specifications: Not changed 5) Function specifications: Partly changed (Example: Manual pulse generator 1/axis → 1/module)
		QD75D1N*1 (when a differential driver is connected)	
	A1SD75P2-S3	QD75P2N*1 (when an open collector is connected)	1) External wiring : Connector and wiring are changed. 2) Number of slots : Not changed 3) Program : I/O signals and buffer memory assignment are changed. The entire program is reviewed according to the specifications change. 4) Performance specifications: Not changed 5) Function specifications: Partly changed (Example: Manual pulse generator 1/axis → 1/module)
		QD75D2N*1 (when a differential driver is connected)	
	A1SD75P3-S3	QD75P4N*1 (when an open collector is connected)	1) External wiring : Connector and wiring are changed. 2) Number of slots : Not changed 3) Program : I/O signals and buffer memory assignment are changed. The entire program is reviewed according to the specifications change. 4) Performance specifications: Not changed 5) Function specifications: Partly changed (Example: Manual pulse generator 1/axis → 1/module)
		QD75D4N*1 (when a differential driver is connected)	
	A1SD75M1	QD75M1	1) External wiring : Connector and wiring are changed. 2) Number of slots : Not changed 3) Program : I/O signals and buffer memory assignment are changed. The entire program is reviewed according to the specifications change. 4) Performance specifications: Upward compatible 5) Function specifications: Partly changed (Example: Manual pulse generator 1/axis → 1/module)
A1SD75M2	QD75M2	1) External wiring : Connector and wiring are changed. 2) Number of slots : Not changed 3) Program : I/O signals and buffer memory assignment are changed. The entire program is reviewed according to the specifications change. 4) Performance specifications: Upward compatible 5) Function specifications: Partly changed (Example: Manual pulse generator 1/axis → 1/module)	

AnS series		Transition to Q series	
Positioning module	A1SD75M3	QD75M4	1) External wiring : Connector and wiring are changed. 2) Number of slots : Not changed 3) Program : I/O signals and buffer memory assignment are changed. The entire program is reviewed according to the specifications change. 4) Performance specifications: Upward compatible 5) Function specifications: Partly changed (Example: Manual pulse generator 1/axis → 1/module)

*1 The QD75P□N and QD75D□N are the upward-compatibility for the QD75P□ and QD75D□ and their programs are the same when they are replaced.

Change the sequence program as necessary with checking the processing timing, because performances such as the starting time and data update cycle are improved.

*2 When the A1SD70 being used in the setting that the negative voltage is output when the positioning address increases is replaced with the QD73A1, the wiring change between the A1SD70 and an encoder is required. For details, refer to Section 8.4.6.

*3 For details on the A1SD71-S2/S7, refer to the following.

- T12-0016 Production discontinuation of MELSEC-A series models
- FA-A-0060 Procedures for Replacing Positioning Module AD71 with QD75

8.2 A1SD75P1-S3/P2-S3/P3-S3

8.2.1 Performance specifications comparison

○: Compatible, △: Partial change required, ×: Incompatible

Model		A1SD75P1-S3	A1SD75P2-S3	A1SD75P3-S3	QD75P1N QD75D1N	QD75P2N QD75D2N	QD75P4N QD75D4N	Compati- bility	Precautions for replacement
Number of control axes		1	2	3	1	2	4	○	
Number of positioning data items		600/axis ^{*1}			600/axis			○	
Position control interpolation function	2-axis linear interpolation	Not available	Available	Available	Not available	Available	Available (3-/4-axis linear interpolation : available)	○	
	2-axis circular interpolation	Not available	Available	Available	Not available	Available	Available		
Positioning system	Position control	Available			Available			○	
	Speed control	Available			Available				
	Speed-position switching control	Available			Available				
	Position-speed switching control	Available			Available				

○: Compatible, △: Partial change required, ×: Incompatible

Item	Model	A1SD75P1-S3	A1SD75P2-S3	A1SD75P3-S3	QD75P1N QD75D1N	QD75P2N QD75D2N	QD75P4N QD75D4N	Compati- bility	Precautions for replacement
Positioning range ^{*2}		<Absolute system> -214748364.8 to 214748364.7 (μm) /-13421772.8 to 13421772.7 (μm) -21474.83648 to 21474.83647 (inch) /-1342.17728 to 1342.17727 (inch) 0 to 359.99999 (degree) /0 to 359.99999 (degree) -2147483648 to 2147483647 (pulse) /-134217728 to 134217727 (pulse) <Incremental system> -214748364.8 to 214748364.7 (μm) /-13421772.8 to 13421772.7 (μm) -21474.83648 to 21474.83647 (inch) /-1342.17728 to 1342.17727 (inch) -21474.83648 to 21474.83647 (degree) /-1342.17728 to 1342.17727 (degree) -2147483648 to 2147483647 (pulse) /-134217728 to 134217727 (pulse) <In speed-position switching control> 0 to 214748364.7 (μm) /0 to 13421772.7 (μm) 0 to 21474.83647 (inch) /0 to 1342.17727 (inch) 0 to 21474.83647 (degree) /0 to 1342.17727 (degree) 0 to 2147483647 (pulse) /0 to 134217727 (pulse)			<Absolute system> -214748364.8 to 214748364.7 (μm) -21474.83648 to 21474.83647 (inch) 0 to 359.99999 (degree) -2147483648 to 2147483647 (pulse) <Incremental system> -214748364.8 to 214748364.7 (μm) -21474.83648 to 21474.83647 (inch) -21474.83648 to 21474.83647 (degree) -2147483648 to 2147483647 (pulse) <In speed-position switching control (INC mode)/position-speed switching control> 0 to 214748364.7 (μm) 0 to 21474.83647 (inch) 0 to 21474.83647 (degree) 0 to 2147483647 (pulse) <In speed-position switching control (ABS mode)> 0 to 359.99999 (degree)			○	
Speed command range ^{*2}		0.01 to 6000000.00 (mm/min) /0.01 to 375000.00 (mm/min) 0.001 to 600000.000 (inch/min) /0.001 to 37500.000 (inch/min) 0.001 to 600000.000 (degree/min) /0.001 to 37500.000 (degree/min) 1 to 1000000 (pulse/s) /1 to 62500 (pulse/s)			0.01 to 20000000.00 (mm/min) 0.001 to 2000000.000 (inch/min) 0.001 to 2000000.000 (degree/min) 1 to 1000000 (pulse/s)			○	
Machine OPR function (OPR method)		Available (6 OPR methods)			Available (6 OPR methods)			○	
JOG operation		Available			Available			○	

○: Compatible, △: Partial change required, ×: Incompatible

Model		A1SD75P1-S3	A1SD75P2-S3	A1SD75P3-S3	QD75P1N QD75D1N	QD75P2N QD75D2N	QD75P4N QD75D4N	Compati- bility	Precautions for replacement
Manual pulse generator function		1 generator/axis			1 generator/module			△	<ul style="list-style-type: none"> On QD75P□N/QD75D□N, the manual pulse generator cannot be used by each axis independent. When connecting the manual pulse generator for each axis is required, use one axis module. The manual pulse generator itself can use the same one. The operation for inputting one pulse differs. Set the parameter so that movement amount may be same.
Starting time		20ms			1.5 to 2.0ms (when other axes are starting: 1.5 to 2.0ms + 0.1ms to 0.5ms)			○	The starting time becomes fast. Check the processing timing.
Acceleration /deceleration processing	Automatic trapezoidal acceleration/deceleration	Available			Available			○	
	S-curve acceleration/deceleration	Available			Available				
Acceleration /deceleration time	Number of patterns	Acceleration time and deceleration time can be set independently. (4 patterns each)			Acceleration time and deceleration time can be set independently. (4 patterns each)			○	
	Setting range	Switching is possible. 1 to 65535ms or 1 to 8388608ms			1 to 8388608ms				
	Sudden stop deceleration	Changeover between 1 to 65535ms/ 1 to 8388608ms possible			1 to 8388608ms				
Compensation		Electronic gears, backlash compensation, near pass*3			Electronic gears, backlash compensation, near pass*3			△	Refer to *3.
Error display		17-segment LED			Error LED			×	To check details of diagnostics, use GX Works2/ GX Developer.
History data storage (Start, error, warning)		Provided (4 types, 16 items/module)			Provided (3 types, 16 items/axis)			○	The start history at error is integrated into the start history.

○: Compatible, △: Partial change required, ×: Incompatible

Item	Model	A1SD75P1-S3	A1SD75P2-S3	A1SD75P3-S3	QD75P1N QD75D1N	QD75P2N QD75D2N	QD75P4N QD75D4N	Compatibility	Precautions for replacement
Data storage destination		Flash ROM (battery-less backup)			Flash ROM (battery-less backup)			○	
Connection connector		10136-3000VE (Soldering type, supplied)			A6CON1 (Soldering type, straight-out type, sold separately)			×	As the connectors differ, wiring change is required. The connectors of QD75P□N/QD75D□N are sold separately.
		10136-6000EL (IDC type, sold separately)			A6CON2 (Crimping type, straight-out type, sold separately)				
					A6CON4 (Soldering type, straight-out/diagonal-out type, sold separately)				
Applicable wire size		10136-3000VE: 24 to 30 AWG (approx. 0.05 to 0.2 mm ²)			A6CON1, A6CON4: 0.3mm ² (22 AWG)			△	
		10136-6000EL: 28 AWG (approx. 0.08 mm ²)			A6CON2: 24 AWG				
Command pulse output system		Differential driver/Open collector			QD75P□N: Open collector QD75D□N: Differential driver			△	The differential driver and the open collector are separate module. In initial condition, A1SD75P□-S3 outputs with positive logic, and QD75P□/D□ outputs with negative logic.
Maximum output pulse		When connected to open collector: 200kpps When connected to differential driver: 400kpps			When connected to open collector: 200kpps When connected to differential driver: 4Mpps			○	
Maximum connection distance between servos		When connected to open collector: 2m When connected to differential driver: 10m			When connected to open collector: 2m When connected to differential driver: 10m			○	
Internal current consumption (A) (5VDC)		0.7A or less (when connected to differential driver: 0.78A)*4			QD75P1N: 0.29A	QD75P2N: 0.30A	QD75P4N: 0.36A	△	
					QD75D1N: 0.43A	QD75D2N: 0.45A	QD75D4N: 0.66A		
Flash ROM write count		Max. 100,000 times			Max. 100,000 times			○	When QD75P□N/QD75D□N carries out the flash write 26 times from the sequence program, an error occurs. The error reset enables to perform the flash write.
Number of occupied I/O points		32 points (I/O assignment: special 32 points)			32 points (I/O assignment: intelligent 32 points)			○	
Number of module occupied slots		1			1			○	

○: Compatible, △: Partial change required, ×: Incompatible

Item	Model	A1SD75P1-S3	A1SD75P2-S3	A1SD75P3-S3	QD75P1N QD75D1N	QD75P2N QD75D2N	QD75P4N QD75D4N	Compatibility	Precautions for replacement
Weight		0.35kg			QD75P1N: 0.14kg	QD75P2N: 0.14kg	QD75P4N: 0.16kg	△	
					QD75D1N: 0.15kg	QD75D2N: 0.15kg	QD75D4N: 0.16kg		
I/O signal for external devices	STRT signal	Available (External start signal)			Not available (integrated into CHG signal)			△	When using both the speed-position switching control and the external start, input the external start signal to the interrupt module, and start using the direct output.
	CHG signal	Speed-position switching signal			External command signal (External start or speed-position switching selectable with parameters)			△	The input response time differs. (Refer to Section 8.2.5.)
	In-position (INP)	Available (for monitoring purpose)			Not available			△	No INP signal. When it is required for monitor, monitor using the input module.
	Signal logic switching	Available (only Command pulse output signal)			Available			○	The default logic of pulse output differs.
	Near-point watchdog signal	Available			Available			△	The input response time differs. (Refer to Section 8.2.5.)
Peripheral devices (data setting, etc.)	Connection with peripheral devices	Direct connection			Connection via programmable controller CPU, Q corresponding serial communication module, Q corresponding MELSECNET/H remote I/O module			○	The connection type differs.
	Teaching module	AD75TU			Not available			×	The teaching module cannot be used.
	Software package	GX Configurator-AP			GX Works2 GX Configurator-QP			△	The software package that can be used differs.

*1 With A1SD75P□-S3, Nos.1 to 100 data items/axis of positioning data can be set using the buffer memory and Nos.1 to 600 data/axis can be set with QD75P□N/QD75D□N.

The positioning data in the buffer memory is not backed up.

*2 Indicates the standard mode/stepping motor mode about A1SD75P□-S3.

*3 The near pass function is valid only during the continuous path control. (A1SD75P□-S3: Selected with parameters, QD75P□N/QD75D□N: Standard function)

QD75P□N/QD75D□N does not have address pass mode. When being asked for passing the positioning address, continue with continuous running. (However, it will stop once.)

*4 This is the internal current consumption when the A1SD75P3-S3 is connected to a differential driver.

8.2.2 Functional comparison

(1) Functions deleted from the A1SD75P1-S3/P2-S3/P3-S3

When the following functions are used with the A1SD75P□-S3, change the program.

Deleted function	Precautions for replacement
Stepping motor mode	The setting is not required when using stepping motor due to its performance gain.
Fast machine OPR	With the QD75P□N/QD75D□N, there is no possible function for replacement.
Special start (stop)	Execute it separately for the start two times.
Indirect designation	In the QD75P□N/QD75D□N, the start block area on the buffer memory is expanded to five blocks (0 to 4). Each start block can be directly designated with positioning start No. (7000 to 7004).
Block transfer	With the A1SD75P□-S3, this interface is used to set positioning data No. 101 to 600 that do not exist on the buffer memory.
Positioning data I/F	Since all positioning data can be set in the buffer memory with the QD75P□N/QD75D□N, this function is deleted.
Start history during errors	The contents are the same as the start history. Therefore, the QD75P□N/QD75D□N stores only the start history.
System monitor data (Module name, OS type, OS version)	These data were deleted because they can be displayed in system monitor "Module's detailed information" of GX Works2/GX Developer.

(2) Functions changed from the A1SD75P1-S3/P2-S3/P3-S3

When the following functions are used with the A1SD75P□-S3, make sure that there is no operation problem after the module is replaced with the QD75P□N/QD75D□N.

Changed function	Description		
Software stroke limit function	<ol style="list-style-type: none"> The software stroke limit check of arc address is carried out only when a sub point is designated. It is not carried out when a center point is designated. The software stroke limit check during speed control is carried out in the following cases: <ul style="list-style-type: none"> When the software stroke limit is applied to the current feed value with Pr.14 and the current feed value is updated with Pr.21 When the software stroke limit is applied to the machine feed value If an attempt is made to change the current value but the designated address is out of the software stroke limit range, the attempt is considered as an error and the current value is not changed. Error code change A1SD75P□-S3: There are 3 types of errors for each software stroke upper limit and lower limit (error code: 509 to 512). QD75P□N/QD75D□N: Errors for the software stroke upper limit are integrated into one (error code: 507). Errors for the software stroke lower limit are integrated into one (error code: 508). Error codes 509 to 512 are deleted. 		
Current value changing M code function	<ol style="list-style-type: none"> An error occurs when the designated new current value is out of the software stroke limit range. The M code setting value is valid during the positioning data current value changing instruction. 		
Acceleration/deceleration speed control	<ol style="list-style-type: none"> An error occurs when the command frequency value calculated from the speed limit value exceeds the maximum command frequency of the positioning module being used. Only two-word type (1 to 8388608ms) can be used as the setting value for the acceleration/deceleration time. 		
Stop process and restart after stop positioning operation stop	<ol style="list-style-type: none"> "Peripheral side (emergency) stop" is deleted from the stop causes of Stop group 2 "sudden stop selection". "Test mode fault" in the stop causes of Stop group 3 "sudden stop selection" is changed to be in the stop causes of Stop group 2 "sudden stop selection". "Stop (QD75 peripheral)" is added to the stop causes of Stop group 3 "sudden stop selection". Error code 100 (Peripheral device stop during operation) is deleted. "Programmable controller CPU error occurrence" is added to the stop causes of Stop group 2 "Sudden stop selection". 		
READY signal (X0)	A1SD75P□-S3	QD75P□N/QD75D□N	
	OFF	Normal (READY)	Not READY/WDT error
	ON	Not READY/WDT error	Normal (READY)
Manual pulse generator operation	The number of connectable manual pulse generators is changed from 1 generator/axis to 1 generator/module.		
Axis operation status	"Step stopped" is changed to "Stopped" and "Step error occurring" is changed to "Error occurring".		
Continuous path control	<ul style="list-style-type: none"> A1SD75P□-S3: If the reference axis operates in reverse direction, the control is internally changed into the continuous positioning control. (restart after deceleration stop) QD75P□N/QD75D□N: Even if the reference axis operates in reverse direction with interpolation, the control remains as the continuous path control. (In single-axis operation, the operation is the same as that of the A1SD75P□-S3.) 		
Near pass	For the continuous path control, only the near pass function is available. Positioning address pass is not conducted.		
2-axis interpolation • 2-axis linear interpolation • 2-axis fixed-feed • Circular interpolation	The interpolation target axis can be randomly set with a positioning identifier.		
Step function	<ol style="list-style-type: none"> "Step stopped" is changed to "Stopped" and "Step error occurring" is changed to "Error occurring" in the axis operations status parameters. The restart command for step start information (02H) is deleted. The step operation is restarted with the restart command. 		

Changed function	Description		
Command in-position function	The command in-position width is expanded. <ul style="list-style-type: none"> AD75A1SD75P□-S3: 1 to 32767000 QD75P□N/QD75D□N: 1 to 2147483647 		
Positioning start No.	7004 to 7010 (block start designation) and 8000 to 8049 (indirect designation) are deleted.		
block start data	With QD75P□N/QD75D□N, the number of blocks has been change to 5 (7000 to 7004). (With the A1SD75P□-S3, this data is called "Positioning start information".)		
Start history	The configuration of "start information" and "start No." is changed so that the start No. can be directly checked.		
Basic parameter1 "Pr.5 Pulse output mode"	When the programmable controller CPU is powered ON or is reset, the valid value is only the first value after the programmable controller READY signal (Y0) turns from OFF to ON.		
Detailed parameters "Pr.15 Software stroke limit valid/invalid setting"		A1SD75P□-S3	QD75P□N/QD75D□N
	0 (Factory setting)	Software stroke limit invalid for manual operation	Software stroke limit valid for manual operation
	1	Software stroke limit valid for manual operation	Software stroke limit invalid for manual operation

8.2.3 I/O signal comparison

Sequence program change is required as the I/O signals differ.

For details of the I/O signals or sequence program, refer to the Type QD75P□N/QD75D□N Positioning Module User's Manual.

Input (X)			Output (Y)		
Signal name	A1SD75P□-S3	QD75P□N/ QD75D□N	Signal name	A1SD75P□-S3	QD75P□N/ QD75D□N
(A1SD75/QD75) READY	X00*	X00*	Axis 1 Positioning start	Y10	Y10
Axis 1 Start complete	X01	X10	Axis 2 Positioning start	Y11	Y11
Axis 2 Start complete	X02	X11	Axis 3 Positioning start	Y12	Y12
Axis 3 Start complete	X03	X12	Axis 4 Positioning start	-	Y13
Axis 4 Start complete	-	X13	Axis 1 Stop	Y13	Y04
Axis 1 BUSY	X04	X0C	Axis 2 Stop	Y14	Y05
Axis 2 BUSY	X05	X0D	Axis 3 Stop	Y1C	Y06
Axis 3 BUSY	X06	X0E	Axis 4 Stop	-	Y07
Axis 4 BUSY	-	X0F	Axis 1 Forward run JOG start	Y16	Y08
Axis 1 Positioning complete	X07	X14	Axis 1 Reverse run JOG start	Y17	Y09
Axis 2 Positioning complete	X08	X15	Axis 2 Forward run JOG start	Y18	Y0A
Axis 3 Positioning complete	X09	X16	Axis 2 Reverse run JOG start	Y19	Y0B
Axis 4 Positioning complete	-	X17	Axis 3 Forward run JOG start	Y1A	Y0C
Axis 1 Error detection	X0A	X08	Axis 3 Reverse run JOG start	Y1B	Y0D
Axis 2 Error detection	X0B	X09	Axis 4 Forward run JOG start	-	Y0E
Axis 3 Error detection	X0C	X0A	Axis 4 Reverse run JOG start	-	Y0F
Axis 4 Error detection	-	X0B	Programmable controller READY	Y1D	Y00
Axis 1 M code ON	X0D	X04	Axis 1 Execution prohibition flag	-	Y14
Axis 2 M code ON	X0E	X05	Axis 2 Execution prohibition flag	-	Y15
Axis 3 M code ON	X0F	X06	Axis 3 Execution prohibition flag	-	Y16
Axis 4 M code ON	-	X07	Axis 4 Execution prohibition flag	-	Y17
Synchronization flag	-	X01	Use prohibited	Y00 to Y0F, Y1E to Y1F	Y01 to Y03, Y18 to Y1F
Use prohibited	X10 to X1F	X02, X03, X18 to X1F			

* The ON/OFF status for READY is different between the QD75P□N/QD75D□N and A1SD75P□-S3.

	Not READY/WDT error	READY
QD75P□N/ QD75D□N	OFF	ON
A1SD75P□-S3	ON	OFF

■ Precautions for replacement

The initial value of the command pulse of A1SD75P□-S3 is positive logic but, QD75P□N/D□N is negative logic.

Replaced at the time, please do the logic of the change in the parameters.

8.2.4 Buffer memory address comparison

Sequence program change is required as the assignment of buffer memory differs.

For details of the buffer memory or sequence program, refer to the Type QD75P□N/QD75D□N Positioning Module User's Manual.

area shows the differences between A1SD75P□-S3 and QD75P□N/QD75D□N.

Item of A1SD75P□-S3	Buffer memory address					
	A1SD75P□-S3			QD75P□N/QD75D□N		
	Axis 1	Axis 2	Axis 3	Axis 1	Axis 2	Axis 3
Pr.1 Unit setting	0	150	300	0	150	300
Pr.2 1 No. of pulses per rotation (Ap)	1	151	301	1	151	301
Pr.3 1 Movement amount per rotation (Al)	2	152	302	2	152	302
Pr.4 Unit magnification (Am)	3	153	303	3	153	303
Pr.5 Pulse output mode	4	154	304	4	154	304
Pr.6 Rotation direction setting	5	155	305	5	155	305
Pr.7 Speed limit value	6	156	306	10	160	310
	7	157	307	11	161	311
Pr.8 Acceleration time 0	8	158	308	12	162	312
	9	159	309	13	163	313
Pr.9 Deceleration time 0	10	160	310	14	164	314
	11	161	311	15	165	315
Pr.10 Bias speed at start	12	162	312	6	156	306
	13	163	313	7	157	307
Pr.11 Stepping motor mode selection	14	164	314	-	-	-
Pr.12 Backlash compensation amount	15	165	315	17	167	317
Pr.13 Software stroke limit upper limit value	16	166	316	18	168	318
	17	167	317	19	169	319
Pr.14 Software stroke limit lower limit value	18	168	318	20	170	320
	19	169	319	21	171	321
Pr.15 Software stroke limit selection	20	170	320	22	172	322
Pr.16 Software stroke limit valid/invalid setting	21	171	321	23	173	323
Pr.17 Command in-position width	22	172	322	24	174	324
Pr.18 Torque limit setting value	23	173	323	25	175	325
	24	174	324	26	176	326
Pr.19 M code ON signal output timing	25	175	325	27	177	327
Pr.20 Speed switching mode	26	176	326	28	178	328
Pr.21 Interpolation speed designation method	27	177	327	29	179	329
Pr.22 Current feed value during speed control	28	178	328	30	180	330
Pr.23 Manual pulse generator selection	29	179	329	-	-	-
Pr.24 Logic selection for pulse output to the drive unit	30	180	330	-	-	-
Pr.25 Size selection for acceleration/deceleration time	31	181	331	-	-	-
Pr.26 Acceleration time 1	36	186	336	36	186	336
	37	187	337	37	187	337
Pr.27 Acceleration time 2	38	188	338	38	188	338
	39	189	339	39	189	339
Pr.28 Acceleration time 3	40	190	340	40	190	340
	41	191	341	41	191	341
Pr.29 Deceleration time 1	42	192	342	42	192	342
	43	193	343	43	193	343

Item of A1SD75P□-S3	Buffer memory address					
	A1SD75P□-S3			QD75P□N/QD75D□N		
	Axis 1	Axis 2	Axis 3	Axis 1	Axis 2	Axis 3
Pr.30 Deceleration time 2	44	194	344	44	194	344
	45	195	345	45	195	345
Pr.31 Deceleration time 3	46	196	346	46	196	346
	47	197	347	47	197	347
Pr.32 JOG Speed limit value	48	198	348	48	198	348
	49	199	349	49	199	349
Pr.33 JOG operation acceleration time selection	50	200	350	50	200	350
Pr.34 JOG operation deceleration time selection	51	201	351	51	201	351
Pr.35 Acceleration/deceleration process selection	52	202	352	52	202	352
Pr.36 S-curve ratio	53	203	353	53	203	353
Pr.37 Sudden stop deceleration time	54	204	354	54	204	354
	55	205	355	55	205	355
Pr.38 Stop group 1 sudden stop selection	56	206	356	56	206	356
Pr.38 Stop group 2 sudden stop selection	57	207	357	57	207	357
Pr.40 Stop group 3 sudden stop selection	58	208	358	58	208	358
Pr.41 Positioning complete signal output time	59	209	359	59	209	359
Pr.42 Allowable circular interpolation error width	60	210	360	60	210	360
	61	211	361	61	211	361
Pr.43 External start function selection	62	212	362	62	212	362
(QD75P□N/QD75D□N: Pr.42 External command function selection)						
Pr.44 Near pass mode selection for path control	66	216	366	-	-	-
Pr.45 OPR method	70	220	370	70	220	370
Pr.46 OPR direction	71	221	371	71	221	371
Pr.37 OP address	72	222	372	72	222	372
	73	223	373	73	223	373
Pr.48 OPR speed	74	224	374	74	224	374
	75	225	375	75	225	375
Pr.49 Creep speed	76	226	376	76	226	376
	77	227	377	77	227	377
Pr.50 OPR retry	78	228	378	78	228	378
Pr.51 OPR dwell time	79	229	379	79	229	379
Pr.52 Setting for the movement amount after near-point dog ON	80	230	380	80	230	380
	81	231	381	81	231	381
Pr.53 OPR acceleration time selection	82	232	382	82	232	382
Pr.54 OPR deceleration time selection	83	233	383	83	233	383
Pr.55 OP shift amount	84	234	384	84	234	384
	85	235	385	85	235	385
Pr.56 OPR torque limit value	86	236	386	86	236	386
Pr.57 Speed designation during OP shift	88	238	388	88	238	388
Pr.58 Dwell time during OPR retry	89	239	389	89	239	389

Item of A1SD75P□-S3	Buffer memory address	
	A1SD75P□-S3	QD75P□N/QD75D□N
	Common for axis 1, 2, 3	Common for axis 1, 2, 3, 4
Md.1 In test mode flag	450	1200
Md.2 Module name	451	-
Md.3 OS type	452 453 454 455	-
Md.4 OS version	456 457	-
Md.5 Clock data (Hour: minute)	460	-
Md.6 Clock data (Second: 100ms)	461	-
(Pointer number)	(0) to (15)	
Md.7 Start axis (QD75P□N/QD75D□N: Md.3 Start information)	462 to 537	1212 to 1287
Md.8 Operation type (QD75P□N/QD75D□N: Md.4 Start No.)	463 to 538	1213 to 1288
Md.9 Start time (Hour: minute) (QD75P□N/QD75D□N: Md.5 Start (Hour))	464 to 539	1214 to 1289
Md.10 Start time (Second: 100ms) (QD75P□N/QD75D□N: Md.6 Start (Minute: second))	465 to 540	1215 to 1290
Md.11 Error judgment	466 to 541	1216 to 1291
Md.12 Start history pointer	542	1292
(Pointer number)	(0) to (15)	-
Md.13 Start axis	543 to 618	-
Md.14 Operation type	544 to 619	-
Md.15 Start time (Hour: minute)	545 to 620	-
Md.16 Start time (Second: 100ms)	546 to 621	-
Md.17 Error judgment	547 to 622	-
Md.18 Start history pointer at error	623	-
(Pointer number)	(0) to (15)	
Md.19 Axis in which the error occurred	624 to 684	1293 to 1353
Md.20 Axis error No.	625 to 685	1294 to 1354
Md.21 Axis error occurrence time (Hour: minute) (QD75P□N/QD75D□N: Md.11 Axis error occurrence (Hour))	626 to 686	1295 to 1355
Md.22 Axis error occurrence time (Second: 100ms) (QD75P□N/QD75D□N: Md.12 Axis error occurrence (Minute: second))	627 to 687	1296 to 1356
Md.23 Error history pointer	688	1357

Item of A1SD75P□-S3	Buffer memory address	
	A1SD75P□-S3	QD75P□N/QD75D□N
	Common for axis 1, 2, 3	Common for axis 1, 2, 3, 4
(Pointer number)	(0) to (15)	
[Md.24] Axis in which the warning occurred	689 to 749	1358 to 1418
[Md.25] Axis warning No.	690 to 750	1359 to 1419
[Md.26] Axis warning occurrence time (Hour: minute) (QD75P□N/QD75D□N: [Md.16] Axis warning occurrence (Hour))	691 to 751	1360 to 1420
[Md.27] Axis warning occurrence time (Second: 100ms) (QD75P□N/QD75D□N: [Md.17] Axis warning occurrence (Minute: second))	3692 to 752	1361 to 1421
[Md.28] Warning history pointer	753	1422

Item of A1SD75P□-S3	Buffer memory address					
	A1SD75P□-S3			QD75P□N/QD75D□N		
	Axis 1	Axis 2	Axis 3	Axis 1	Axis 2	Axis 3
Md.29 Current feed value	800	900	1000	800	900	1000
	801	901	1001	801	901	1001
Md.30 Machine feed value	802	902	1002	802	902	1002
	803	903	1003	803	903	1003
Md.31 Feedrate	804	904	1004	804	904	1004
	805	905	1005	805	905	1005
Md.32 Valid M code	806	906	1006	808	908	1008
Md.33 Axis error No.	807	907	1007	806	906	1006
Md.34 Axis warning No.	808	908	1008	807	907	1007
Md.35 Axis operation status	809	909	1009	809	909	1009
Md.36 Current speed	810	910	1010	810	910	1010
	811	911	1011	811	911	1011
Md.37 Axis feedrate	812	912	1012	812	912	1012
	813	913	1013	813	913	1013
Md.38 Speed-position switching control positioning amount	814	914	1014	814	914	1014
	815	915	1015	815	915	1015
Md.39 External input/output signal	816	916	1016	816	916	1016
Md.40 Status	817	917	1017	817	917	1017
Md.41 Target value	818	918	1018	818	918	1018
	819	919	1019	819	919	1019
Md.42 Target speed	820	920	1020	820	920	1020
	821	921	1021	821	921	1021
Md.43 OP absolute position	822	922	1022	-	-	-
	823	923	1023	-	-	-
Md.44 Movement amount after near-point dog ON	824	924	1024	824	924	1024
	825	925	1025	825	925	1025
Md.45 Torque limit stored value	826	926	1026	826	926	1026
Md.46 Special start data instruction code setting value	827	927	1027	827	927	1027
Md.47 Special start data instruction parameter setting value	828	928	1028	828	928	1028
Md.48 Start positioning data No. setting value	829	929	1029	829	929	1029
Md.49 In speed limit flag	830	930	1030	830	930	1030
Md.50 In speed change processing flag	831	931	1031	831	931	1031
Md.51 Start data pointer being executed	832	932	1032	834	934	1034
Md.52 Last executed positioning data No.	833	933	1033	837	937	1037
Md.53 Repeat counter						
(QD75P□N/QD75D□N: Md.41 Special start repetition counter)	834	934	1034	832	932	1032
Md.54 Positioning data No. being executed	835	935	1035	835	935	1035
Md.55 Block No. being executed	836	936	1036	836	936	1036
Md.56 Positioning data being executed	838 to 847	938 to 947	1038 to 1047	838 to 847	938 to 947	1038 to 1047
Deceleration starting flag	-	-	-	899	999	1099

Item of A1SD75P□-S3	Buffer memory address					
	A1SD75P□-S3			QD75P□N/QD75D□N		
	Axis 1	Axis 2	Axis 3	Axis 1	Axis 2	Axis 3
Cd.1 Clock data setting (hour)	1100			-		
Cd.2 Clock data setting (minute, second)	1101			-		
Cd.3 Clock data writing	1102			-		
Cd.4 Target axis	1103			-		
Cd.5 Positioning data No.	1104			-		
Cd.6 Write pattern	1105			-		
Cd.7 Read/write request	1106			-		
Cd.8 Read/write positioning data I/F	1108 to 1137			-		
Cd.9 Flash ROM write request	1138			1900		
Cd.10 Parameter initialization request	1139			1901		
Cd.11 Positioning start No.	1150	1200	1250	1500	1600	1700
Cd.12 Axis error reset	1151	1201	1251	1502	1602	1702
Cd.13 Restart command	1152	1202	1252	1503	1603	1703
Cd.14 M code OFF request	1153	1203	1253	1504	1604	1704
Cd.15 New current value	1154	1204	1254	1506	1606	1706
	1155	1205	1255	1507	1607	1707
Cd.16 New speed value	1156	1206	1256	1514	1614	1714
	1157	1207	1257	1515	1615	1715
Cd.17 Speed change request	1158	1208	1258	1516	1616	1716
Cd.18 Positioning operation speed override	1159	1209	1259	1513	1613	1713
Cd.19 JOG speed	1160	1210	1260	1518	1618	1718
	1161	1211	1261	1519	1619	1719
Cd.20 Speed-position switching enable flag	1163	1213	1263	1528	1628	1728
Cd.21 Speed-position switching control movement amount change register	1164	1214	1264	1526	1626	1726
	1165	1215	1265	1527	1627	1727
Cd.22 Manual pulse generator enable flag	1167	1217	1267	1524	1624	1724
Cd.23 Manual pulse generator 1 pulse input magnification	1168	1218	1268	1522	1622	1722
	1169	1219	1269	1523	1623	1723
Cd.24 OPR request flag OFF request	1170	1220	1270	1521	1621	1721
Cd.25 External start valid	1171	1221	1271	1505	1605	1705
(QD75P□N/QD75D□N: Cd.8 External command valid)						
Cd.26 Step valid flag	1172	1222	1272	1545	1645	1745
Cd.27 Step mode	1173	1223	1273	1544	1644	1744
Cd.28 Step start information	1174	1224	1274	1546	1646	1746
Cd.29 Skip command	1175	1225	1275	1547	1647	1747
Cd.30 New torque value	1176	1226	1276	1525	1625	1725
Cd.31 Positioning starting point No.	1178	1228	1278	1501	1601	1701
Cd.32 Interrupt request during continuous operation	1181	1231	1281	1520	1620	1720
Cd.33 New acceleration time value	1184	1234	1284	1508	1608	1708
	1185	1235	1285	1509	1609	1709
Cd.34 New deceleration time value	1186	1236	1286	1510	1610	1710
	1187	1237	1287	1511	1611	1711
Cd.35 Acceleration/deceleration time change during speed change, enable/disable selection	1188	1238	1288	1512	1612	1712

Item of A1SD75P□-S3		Buffer memory address													
		A1SD75P□-S3						QD75P□□/QD75D□□							
		Axis 1		Axis 2		Axis 3		Axis 1		Axis 2		Axis 3			
Positioning data*1	Da.1 Operation pattern	No.1	1300		2300		3300		2000		8000		14000		
	Da.2 Control system														
	Da.3 Acceleration time No.														
	Da.4 Deceleration time No.														
	Da.9 M code/condition data No.		1301		2301		3301		2001		8001		14001		
	Da.8 Dwell time/JUMP destination positioning data No.		1302		2302		3302		2002		8002		14002		
	Not used		1303		2303		3303		2003		8003		14003		
	Da.7 Command speed		1304		2304		3304		2004		8004		14004		
	Da.5 Positioning address/movement amount		1305		2305		3305		2005		8005		14005		
			1306		2306		3306		2006		8006		14006		
Da.6 Arc address	1307		2307		3307		2007		8007		14007				
	1308		2308		3308		2008		8008		14008				
No.2		1309		2309		3309		2009		8009		14009			
No.2		1310 to 1319		2310 to 2319		3310 to 3319		2010 to 2019		8010 to 8019		14010 to 14019			
No.3		1320 to 1329		2320 to 2329		3320 to 3329		2020 to 2029		8020 to 8029		14020 to 14029			
to		to		to		to		to		to		to			
No.100		2290 to 2299		3290 to 3299		4290 to 4299		2990 to 2999		8990 to 8999		14990 to 14999			
Start block data*2	Da.10 Shape	1st point	4300 4350		4550 4600		4800 4850		26000 26050		27000 27050		28000 28050		
	Da.11 Start data No.														
	Da.12 Special start instruction														
	Da.13 Parameter														
	2nd point														4301 4351
3rd point	4302 4352		4552 4602		4802 4852		26002 26052		27002 27052		28002 28052				
to		to		to		to		to		to		to			
50th point		4349 4399		4599 4649		4849 4899		26049 26099		27049 27099		28049 28099			
Positioning start information*3	Da.14 Condition target	No.1	4400		4650		4900		26100		27100		28100		
	Da.15 Condition operator														
	Da.16 Address		4402		4652		4902		26102		27102		28102		
			4403		4653		4903		26103		27103		28103		
	Da.17 Parameter 1		4404		4654		4904		26104		27104		28104		
			4405		4655		4905		26105		27105		28105		
	Da.18 Parameter 2		4406		4656		4906		26106		27106		28106		
			4407		4657		4907		26107		27107		28107		
	No.2		4410 to 4419		4660 to 4669		4910 to 4919		26110 to 26119		27110 to 27119		28110 to 28119		
	No.3		4420 to 4429		4670 to 4679		4920 to 4929		26120 to 26129		27120 to 27129		28120 to 28129		
to		to		to		to		to		to		to			
No.10		4490 to 4499		4740 to 4749		4990 to 4999		26190 to 26199		27190 to 27199		28190 to 28199			

*1 With the QD75P□□/QD75D□□, the positioning data buffer memory addresses are No. 1 to 600.

*2 With the QD75P□□/QD75D□□, it is called "block start data".

*3 With the QD75P□□/QD75D□□, the "block start data" and "condition data" in are called "start block 0". There are five start blocks: 0 to 4.

Item of A1SD75P□-S3			Buffer memory address					
			A1SD75P□-S3			QD75P□N/QD75D□N		
			Axis 1	Axis 2	Axis 3	Axis 1	Axis 2	Axis 3
Positioning start information	Indirect designation	Start No.8001	4500	4750	5000	-	-	-
		Start No.8002	4501	4751	5001	-	-	-
		to	to	to	to	to	to	
		Start No.8050	4549	4799	5049	-	-	-
Programmable controller CPU memory area	Condition judgment target data of the condition data		5050			30000		
			to			to		
			5099			30049		
Target axis			5100			-		
Head positioning block No.			5101			-		
No. of read/write data items			5102			-		
Read/write request			5103			-		
Read/write block			5110 to 6109			-		

8.2.5 External interface specifications comparison

The following table lists the differences of the external interface specifications between the A1SD75P□-S3 and QD75P□N/QD75D□N.

○ : Compatible, △ : Partial change required

	Item ^{*1}	Difference ^{*2}	Compat- ibility	Precautions for replacement
Input	Drive unit READY	-	○	
	Upper/lower limit signal	-	○	
	Stop signal	-	○	
	Near-point dog signal	Input resistance: 4.7kΩ → 4.3kΩ Response time: 4ms → 1ms	△	<When the machine OPR for the near-point watchdog signal method is used> The input response time for the QD75P□/D□ is shorter than the A1SD75P□-S3. If a sensor, which the chattering time when the near-point watchdog signal is turned on is long, is used, an error may occur due to the false detection of the ON/OFF status. ^{*4} Check specifications for the sensor.
	External command signal (CHG)	Input resistance: 4.7kΩ → 4.3kΩ Response time: 4ms → 1ms	△	
	Zero signal	Input resistance: 3.5kΩ → 4.7kΩ (at input of 24V) 0.5kΩ → 0.62kΩ (at input of 5V) Response time: 0.8ms → 1ms ^{*3} ON voltage : 2.5V → 2.0V (at input of 5V)	△	Including the response time differences, reconfirming is required.
Output	Manual pulse generator	ON current: 3.5mA → 2mA	○	
	Pulse	-	○	
	Deviation counter clear	-	○	

*1 For the external start and in-position signal of which QD75P□N/QD75D□N does not have, they are not described.

*2 The column of interface specifications differences is described as the form, [Specifications of A1SD75P□-S3] → [Specifications of QD75P□N/QD75D□N].

*3 The response time difference (0.2 ms) of A1SD75P□-S3 and QD75P□N/QD75D□N is the time difference of 1pls part for creep speed of 5000pps.

When the accuracy is required, it is required for the creep speed to be low enough value.

*4 If the chattering time is long when the near-point watchdog signal is turned on, the OFF status may be detected shortly after the ON status of the signal is detected (under changing into the creep speed). In this case, the QD75P□N/QD75D□N outputs an error and stops the OPR control.

8.3 A1SD75M1/M2/M3

8.3.1 Performance specifications comparison

○ : Compatible, △ : Partial change required, × : Incompatible

Model		A1SD75M1	A1SD75M2	A1SD75M3	QD75M1	QD75M2	QD75M4	Com- patibil- ity	Precautions for replacement
Item		1	2	3	1	2	4		
Number of control axes		1	2	3	1	2	4	○	
Number of positioning data items		600/axis*1			600/axis			○	
Position control interpolation functions	2-axis linear interpolation	Not available	Available	Available	Not available	Available	Available	○	
	2-axis circular interpolation	Not available	Available	Available	Not available	Available	Available		
Positioning system	Position control	Available			Available			○	
	Speed control	Available			Available				
	Speed-position switching control	Available			Available				
	Position-speed switching control	Not available			Available				
Positioning range		<In Absolute system> -214748364.8 to 214748364.7 (μm) -21474.83648 to 21474.83647 (inch) 0 to 359.99999 (degree) -2147483648 to 2147483647 (pulse) <Incremental system> -214748364.8 to 214748364.7 (μm) -21474.83648 to 21474.83647 (inch) -21474.83648 to 21474.83647 (degree) -2147483648 to 2147483647 (pulse) <In speed-position switching control> 0 to 214748364.7 (μm) 0 to 21474.83647 (inch) 0 to 21474.83647 (degree) 0 to 2147483647 (pulse)			<In Absolute system> -214748364.8 to 214748364.7 (μm) -21474.83648 to 21474.83647 (inch) 0 to 359.99999 (degree) -2147483648 to 2147483647 (pulse) <Incremental system> -214748364.8 to 214748364.7 (μm) -21474.83648 to 21474.83647 (inch) -21474.83648 to 21474.83647 (degree) -2147483648 to 2147483647 (pulse) <In speed-position switching control> 0 to 214748364.7 (μm) 0 to 21474.83647 (inch) 0 to 21474.83647 (degree) 0 to 2147483647 (pulse)			○	
Speed command range		0.01 to 6000000.00 (mm/min) 0.001 to 600000.000 (inch/min) 0.001 to 600000.000 (degree/min) 1 to 1000000 (pulse/s)			0.01 to 20000000.00 (mm/min) 0.001 to 2000000.000 (inch/min) 0.001 to 2000000.000 (degree/min) 1 to 10000000 (pulse/s)			○	
Machine OPR function (OPR method)		Available (6 OPR methods)			Available (4 OPR methods)			△	Corresponding to the OP unpassed error is required. Return the motor more than one rotation once at the error and perform the OPR start again.
JOG operation		Available			Available			○	

○: Compatible, △: Partial change required, ×: Incompatible

Item		Model				Com- patibil- ity	Precautions for replacement	
		A1SD75M1	A1SD75M2	A1SD75M3	QD75M1			QD75M2
Manual pulse generator function		1 generator/axis			1 generator/module		△	<ul style="list-style-type: none"> On QD75M□, the manual pulse generator cannot be used by each axis independent. When connecting the manual pulse generator for each axis is required, use one axis module. The manual pulse generator itself can use the same one. The operation for inputting one pulse differs. Set the parameter so that movement amount may be same.
Acceleration /deceleration process	Automatic trapezoidal acceleration/deceleration	Available			Available		○	
	S-pattern acceleration/deceleration	Available			Available			
Acceleration /deceleration time	Number of patterns	Acceleration time and deceleration time can be set independently. (4 patterns each)		Acceleration time and deceleration time can be set independently. (4 patterns each)		○		
	setting range	Switching is possible. 1 to 65535ms or 1 to 8388608ms		1 to 8388608ms				
Compensation		Electronic gears, backlash compensation, near pass ^{*2}		Electronic gears, backlash compensation, near pass ^{*2}		△	Refer to *2.	
Error display		17-segment LED			Error LED		×	To check details of diagnostics, use GX Works2/GX Developer.
History data storage (Start, error, warning)		Provided (4 types, 16 items/module)			Provided (3 types, 16 items/axis)		○	The start history at error is integrated into the start history.
Data storage destination		Flash ROM (battery-less backup)			Flash ROM (battery-less backup)		○	

○ : Compatible, △ : Partial change required, × : Incompatible

Model		A1SD75M1	A1SD75M2	A1SD75M3	QD75M1	QD75M2	QD75M4	Com- patibil- ity	Precautions for replacement
Item									
Connection connector		10136-3000VE (Soldering type, supplied)			A6CON1, A6CON4 (Soldering type, sold separately)			×	As the connectors differ, wiring change is required.
		10136-6000EL (IDC type, sold separately)			A6CON2 (Crimping type, sold separately)				
		-			A6CON3 (IDC type, sold separately)				
Applicable wire size		10136-3000VE: 24 to 30 AWG (approx. 0.05 to 0.2mm ²)			A6CON1, A6CON4: 0.3mm ²			○	The connectors of QD75M□ is sold separately.
		10136-6000EL: 28 AWG (approx. 0.08mm ²)			A6CON2: 24 to 28 AWG				
		-			A6CON3: 28 AWG (twisted wire), 30 AWG (single wire)				
SSCNET connection type	Refer to Section 8.3.5 (2).								
Maximum extension distance of SSCNET	30m							△	Shape of a bus connector differs.
Internal current consumption (A) (5DVC)	0.7A or less			0.40A			○		
Flash ROM write count	Max. 100,000 times			Max. 100,000 times			○	When QD75M□ carries out the flash write 26 times from the sequence program, an error occurs. The error reset enables to perform the flash write.	
Number of occupied I/O points	32 points (I/O assignment: special 32 points)			32 points (I/O assignment: intelligent 32 points)			○		
Number of module occupied slots	1			1			○		
Weight	0.35kg			0.15kg	0.15kg	0.16kg	○		
I/O signal for external devices	START signal	Available			Not available (integrated into CHG signal)			△	When using both the speed-position switching control and the external start, input the external start signal to the interrupt module and start using the direct output.
	CHG signal	Speed-position switching signal			External command signal (External start or speed-position switching selectable with parameters)			△	
Peripheral devices (data setting, etc.)	Connection with peripheral devices	Direct connection			Connection via programmable controller CPU, Q corresponding serial communication module, Q corresponding MELSECNET/H remote I/O module			○	The connection type differs.
	Teaching module	AD75TU			Not available			×	The teaching module cannot be used.
	Software package	GX Configurator-AP			GX Works2 GX Configurator-QP*3			○	The software package that can be used differs.

- *1 No.1 to 100 data items/axis of positioning data can be set using the buffer memory and No.1 to 600 data/axis can be set with QD75M□.
The positioning data in the buffer memory is not backed up.
- *2 The near pass function is valid only during the continuous path control. (A1SD75M□: Selected with parameters, QD75M□: Standard function)
QD75M□ does not have address pass mode. If passing the positioning address, continue with continuous operation. (However, it will stop once.)
- *3 GX Configurator-QP is available with SW2D5C-QD75P or later version.

8.3.2 Functional comparison

(1) Functions deleted from the A1SD75M1/A1SD75M2/A1SD75M3

When the following functions are used with the A1SD75M□, change the program.

Deleted function	Precautions for replacement
Creep speed out of range error (error code: 208)	With the QD75M□, there is no the error code of the left column.
Fast machine OPR	With the QD75M□, there is no possible function for replacement.
Special start (stop)	Execute it separately for the start two times.
Indirect designation	In the QD75M□, the start block area on the buffer memory is expanded to five blocks (0 to 4). Each start block can be directly designated with positioning start No. (7000 to 7004).
Block transfer	With the A1SD75M□, this interface is used to set positioning data No. 101 to 600 that do not exist on the buffer memory. Since all positioning data can be set in the buffer memory with the QD75M□, this function is deleted.
Positioning data I/F	
Start history during errors	The contents are the same as the start history. Therefore, the QD75M□ stores only the start history.
System monitor data (Module name, OS type, OS version)	These data were deleted because they can be displayed in system monitor "Module's detailed information" of GX Works2/GX Developer.

(2) Functions changed from the A1SD75M1/A1SD75M2/A1SD75M3

When the following functions are used with the A1SD75M□, make sure that there is no operation problem after the module is replaced with the QD75M□.

Changed function	Description		
Software stroke limit function	<ol style="list-style-type: none"> The software stroke limit check of arc address is carried out only when a sub point is designated. It is not carried out when a center point is designated. The software stroke limit check during speed control is carried out in the following cases: <ul style="list-style-type: none"> When the software stroke limit is applied to the current feed value with [Pr.14] and the current feed value is updated with [Pr.21] When the software stroke limit is applied to the machine feed value If an attempt is made to change the current value but the designated address is out of the software stroke limit range, the attempt is considered as an error and the current value is not changed. Error code change A1SD75M□: There are 3 types of errors for each software stroke upper limit and lower limit (error code: 509 to 512). QD75M□: Errors for the software stroke upper limit are integrated into one (error code: 507). Errors for the software stroke lower limit are integrated into one (error code: 508). Error codes 509 to 512 are deleted. 		
Current value changing M code function	<ol style="list-style-type: none"> An error occurs when the designated new current value is out of the software stroke limit range. The M code setting value is valid during the positioning data current value changing instruction. 		
Acceleration/deceleration speed control	Only two-word type (1 to 8388608ms) can be used as the setting value for the acceleration/deceleration time.		
Stop process and restart after stop positioning operation stop	<ol style="list-style-type: none"> "Peripheral side (emergency) stop" is deleted from the stop causes of Stop group 2 "sudden stop selection". "Test mode fault" in the stop causes of Stop group 3 "sudden stop selection" is changed to be in the stop causes of Stop group 2 "sudden stop selection". "Stop (QD75 peripheral)" is added to the stop causes of Stop group 3 "sudden stop selection". Error code 100 (Peripheral device stop during operation) is deleted. "Programmable controller CPU error occurrence" is added to the stop causes of Stop group 2 "Sudden stop selection". 		
READY signal (X0)		A1SD75M□	QD75M□
	OFF	Normal (READY)	Not READY/WDT error
	ON	Not READY/WDT error	Normal (READY)
Manual pulse generator operation	The number of connectable manual pulse generators is changed from 1 generator/axis to 1 generator/module.		
Axis operation status	"Step stopped" is changed to "Stopped" and "Step error occurring" is changed to "Error occurring".		
Continuous path control	<ul style="list-style-type: none"> A1SD75M□: If the reference axis operates in reverse direction, the control is internally changed into the continuous positioning control. (restart after deceleration stop) QD75M□: Even if the reference axis operates in reverse direction with interpolation, the control remains as the continuous path control. (In single-axis operation, the operation is the same as that of the A1SD75M□.) 		
Near pass	For the continuous path control, only the near pass function is available. Path of positioning address pass is not conducted.		
2-axis interpolation <ul style="list-style-type: none"> 2-axis linear interpolation 2-axis fixed-feed Circular interpolation 	The interpolation target axis can be randomly set with a positioning identifier.		
Step function	<ol style="list-style-type: none"> "Step stopped" is changed to "Stopped" and "Step error occurring" is changed to "Error occurring" in the axis operations status parameters. The restart command for step start information (02H) is deleted. The step operation is restarted with the restart command. 		

Changed function	Description		
Command in-position function	The command in-position width is expanded. • A1SD75M□: 1 to 32767000 • QD75M□: 1 to 2147483647		
Positioning start No.	7004 to 7010 (block start designation) and 8000 to 8049 (indirect designation) are deleted.		
Block start data	With QD75M□, the number of blocks has been change to 5 (7000 to 7004). (With the A1SD75M□, this data is called "Positioning start information".)		
Start history	The configuration of start information and start No. is changed so that the start No. can be directly checked.		
Detailed parameters "Pr.15 Software stroke limit valid/ invalid setting"		A1SD75M□	QD75M□
	0 (Factory setting)	Software stroke limit invalid for manual operation	Software stroke limit valid for manual operation
	1	Software stroke limit valid for manual operation	Software stroke limit invalid for manual operation

8.3.3 I/O signal comparison

Sequence program change is required as the I/O signals differ.

For details of the I/O signals or sequence program, refer to the Type QD75M Positioning Module User's Manual.

Input (X)			Output (Y)		
Signal name	A1SD75M□	QD75M□	Signal name	A1SD75M□	QD75M□
(A1SD75/QD75) READY	X00*	X00*	Axis 1 Positioning start	Y10	Y10
Axis 1 Start complete	X01	X10	Axis 2 Positioning start	Y11	Y11
Axis 2 Start complete	X02	X11	Axis 3 Positioning start	Y12	Y12
Axis 3 Start complete	X03	X12	Axis 4 Positioning start	-	Y13
Axis 4 Start complete	-	X13	Axis 1 Stop	Y13	Y04
Axis 1 BUSY	X04	X0C	Axis 2 Stop	Y14	Y05
Axis 2 BUSY	X05	X0D	Axis 3 Stop	Y1C	Y06
Axis 3 BUSY	X06	X0E	Axis 4 Stop	-	Y07
Axis 4 BUSY	-	X0F	All axes servo ON	Y15	Y01
Axis 1 Positioning complete	X07	X14	Axis 1 Forward run JOG start	Y16	Y08
Axis 2 Positioning complete	X08	X15	Axis 1 Reverse run JOG start	Y17	Y09
Axis 3 Positioning complete	X09	X16	Axis 2 Forward run JOG start	Y18	Y0A
Axis 4 Positioning complete	-	X17	Axis 2 Reverse run JOG start	Y19	Y0B
Axis 1 Error detection	X0A	X08	Axis 3 Forward run JOG start	Y1A	Y0C
Axis 2 Error detection	X0B	X09	Axis 3 Reverse run JOG start	Y1B	Y0D
Axis 3 Error detection	X0C	X0A	Axis 4 Forward run JOG start	-	Y0E
Axis 4 Error detection	-	X0B	Axis 4 Reverse run JOG start	-	Y0F
Axis 1 M code ON	X0D	X04	Programmable controller READY	Y1D	Y00
Axis 2 M code ON	X0E	X05	Axis 1 Execution prohibition flag	-	Y14
Axis 3 M code ON	X0F	X06	Axis 2 Execution prohibition flag	-	Y15
Axis 4 M code ON	-	X07	Axis 3 Execution prohibition flag	-	Y16
Synchronization flag	-	X01	Axis 4 Execution prohibition flag	-	Y17
Use prohibited	X10 to X1F	X02, X03, X18 to X1F	Use prohibited	Y00 to Y0F, Y1E to Y1F	Y02, Y03, Y18 to Y1F

* The ON/OFF status for READY is different between the QD75M□/and A1SD75M□.

	Not READY/WDT error	READY
QD75M□	OFF	ON
A1SD75M□	ON	OFF

8.3.4 Buffer memory address comparison

Sequence program change is required as the assignment of buffer memory differs.

For details of the buffer memory or sequence program, refer to the Type QD75M Positioning Module User's Manual.

area shows the differences between A1SD75M□ and QD75M□.

Item of A1SD75M□	Buffer memory address					
	A1SD75M□			QD75M□		
	Axis 1	Axis 2	Axis 3	Axis 1	Axis 2	Axis 3
Pr.1 Unit setting	0	150	300	0	150	300
Pr.2 No. of pulses per rotation (AP)	1	151	301	2	152	302
				3	153	303
Pr.3 Movement amount per rotation (AL)	2	152	302	4	154	304
				5	155	305
Pr.4 Unit magnification (AM)	3	153	303	1	151	301
Pr.7 Speed limit value	6	156	306	10	160	310
	7	157	307	11	161	311
Pr.8 Acceleration time 0	8	158	308	12	162	312
	9	159	309	13	163	313
Pr.9 Deceleration time 0	10	160	310	14	164	314
	11	161	311	15	165	315
Pr.10 Bias speed at start	12	162	312	6	156	306
	13	163	313	7	157	307
Pr.12 Backlash compensation amount	15	165	315	17	167	317
Pr.13 Software stroke limit upper limit value	16	166	316	18	168	318
	17	167	317	19	169	319
Pr.14 Software stroke limit lower limit value	18	168	318	20	170	320
	19	169	319	21	171	321
Pr.15 Software stroke limit selection	20	170	320	22	172	322
Pr.16 Software stroke limit valid/invalid setting	21	171	321	23	173	323
Pr.17 Command in-position width	22	172	322	24	174	324
	23	173	323	25	175	325
Pr.18 Torque limit setting value	24	174	324	26	176	326
Pr.19 M code ON signal output timing	25	175	325	27	177	327
Pr.20 Speed switching mode	26	176	326	28	178	328
Pr.21 Interpolation speed designation method	27	177	327	29	179	329
Pr.22 Current feed value during speed control	28	178	328	30	180	330
Pr.23 Manual pulse generator selection	29	179	329	33	-	-
Pr.25 Size selection for acceleration/ deceleration time	31	181	331	-	-	-
Speed-position function selection	-	-	-	34	184	334
Pr.26 Acceleration time 1	36	186	336	36	186	336
	37	187	337	37	187	337
Pr.27 Acceleration time 2	38	188	338	38	188	338
	39	189	339	39	189	339
Pr.28 Acceleration time 3	40	190	340	40	190	340
	41	191	341	41	191	341

Item of A1SD75M□	Buffer memory address					
	A1SD75M□			QD75M□		
	Axis 1	Axis 2	Axis 3	Axis 1	Axis 2	Axis 3
Pr.29 Deceleration time 1	42	192	342	42	192	342
	43	193	343	43	193	343
Pr.30 Deceleration time 2	44	194	344	44	194	344
	45	195	345	45	195	345
Pr.31 Deceleration time 3	46	196	346	46	196	346
	47	197	347	47	197	347
Pr.32 JOG speed limit value	48	198	348	48	198	348
	49	199	349	49	199	349
Pr.33 JOG operation acceleration time selection	50	200	350	50	200	350
Pr.34 JOG operation deceleration time selection	51	201	351	51	201	351
Pr.35 Acceleration/deceleration process selection	52	202	352	52	202	352
Pr.36 S-pattern proportion	53	203	353	53	203	353
Pr.37 Sudden stop deceleration time	54	204	354	54	204	354
	55	205	355	55	205	355
Pr.38 Stop group 1 sudden stop selection	56	206	356	56	206	356
Pr.39 Stop group 2 sudden stop selection	57	207	357	57	207	357
Pr.40 Stop group 3 sudden stop selection	58	208	358	58	208	358
Pr.41 Positioning complete signal output time	59	209	359	59	209	359
Pr.42 Allowable circular interpolation error width	60	210	360	60	210	360
	61	211	361	61	211	361
Pr.43 External start function selection (QD75M□: Pr.42 External command function selection)	62	212	362	62	212	362
Pr.150 Setting for the restart allowable range when servo OFF to ON	64	214	364	64	214	364
	65	215	365	65	215	365
Pr.44 Near pass mode selection for path control	66	216	366	-	-	-
Pr.45 OPR method	70	220	370	70	220	370
Pr.46 OPR direction	71	221	371	71	221	371
Pr.47 OP address	72	222	372	72	222	372
	73	223	373	73	223	373
Pr.48 OPR speed	74	224	374	74	224	374
	75	225	375	75	225	375
Pr.49 Creep speed	76	226	376	76	226	376
	77	227	377	77	227	377
Pr.50 OPR retry	78	228	378	78	228	378
OPR dwell time	-	-	-	79	229	379
Pr.52 Setting for the movement amount after near-point dog ON	80	230	380	80	230	380
	81	231	381	81	231	381
Pr.53 OPR acceleration time selection	82	232	382	82	232	382
Pr.54 OPR deceleration time selection	83	233	383	83	233	383
Pr.55 OP shift amount	84	234	384	84	234	384
	85	235	385	85	235	385
Pr.56 OPR torque limit value	86	236	386	86	236	386

Item of A1SD75M□	Buffer memory address					
	A1SD75M□			QD75M□		
	Axis 1	Axis 2	Axis 3	Axis 1	Axis 2	Axis 3
Pr.57 Speed designation during OP shift	88	238	388	88	238	388
Pr.58 Dwell time during OPR retry	89	239	389	89	239	389
Pr.59 Absolute position restoration selection	91	241	391	-	-	-
Pr.100 Servo series	100	250	400	30100	30200	30300
Pr.101 Amplifier setting	101	251	401	30101	30201	30301
Pr.102 Regenerative brake resistor	102	252	402	30102	30202	30302
Pr.103 Motor type	103	253	403	30103	30203	30303
Pr.104 Motor capacity	104	254	404	30104	30204	30304
Pr.105 Motor speed	105	255	405	30105	30205	30305
Pr.106 Feedback pulse	106	256	406	30106	30206	30306
Pr.107 Rotation direction	107	257	407	30107	30207	30307
Pr.108 Auto tuning	108	258	408	30108	30208	30308
Pr.109 Servo response setting	109	259	409	30109	30209	30309
Maker setting	-	-	-	30110	30210	30310
Maker setting	-	-	-	30111	30211	30311
Pr.112 Load inertia ratio	112	262	412	30112	30212	30312
Pr.113 Position loop gain 1	113	263	413	30113	30213	30313
Pr.114 Speed loop gain 1	114	264	414	30114	30214	30314
Pr.115 Position loop gain 2	115	265	415	30115	30215	30315
Pr.116 Speed loop gain 2	116	266	416	30116	30216	30316
Pr.117 Speed integral compensation	117	267	417	30117	30217	30317
Pr.118 Notch filter selection	118	268	418	30118	30218	30318
Pr.119 Feed forward gain	119	269	419	30119	30219	30319
Pr.120 In-position range	120	270	420	30120	30220	30320
Pr.121 Electromagnetic brake sequence output	121	271	421	30121	30221	30321
Pr.122 Monitor output mode selection	122	272	422	30122	30222	30322
Pr.123 Optional function 1	123	273	423	30123	30223	30323
Pr.124 Optional function 2	124	274	424	30124	30224	30324
Pr.125 Adaptive vibration suppression control/low pass filter	125	275	425	30125	30225	30325
Maker setting	-	-	-	30126	30226	30326
Pr.127 Monitor output 1 offset	127	277	427	30127	30227	30327
Pr.128 Monitor output 2 offset	128	278	428	30128	30228	30328
Pr.129 Pre-alarm data selection	129	279	429	30129	30229	30329
Pr.130 Zero speed	130	280	430	30130	30230	30330
Pr.131 Error excessive alarm level	131	281	431	30131	30231	30331
Pr.132 Optional function 5	132	282	432	30132	30232	30332
Pr.133 Optional function 6	133	283	433	30133	30233	30333
Pr.134 PI-PID control switch-over position droop	134	284	434	30134	30234	30334
Maker setting	-	-	-	30135	30235	30335

Item of A1SD75M□	Buffer memory address					
	A1SD75M□			QD75M□		
	Axis 1	Axis 2	Axis 3	Axis 1	Axis 2	Axis 3
[Pr.136] Speed differential compensation	136	286	436	30136	30236	30336
Maker setting	-	-	-	30137	30237	30337
[Pr.138] Encoder output pulses	138	288	438	30138	30238	30338
[Pr.149] Servo parameter transmission setting	149	299	449	-	-	-
Maker setting	-	-	-	30139	30239	30339
Maker setting	-	-	-	30140	30240	30340
Maker setting	-	-	-	30141	30241	30341
Maker setting	-	-	-	30142	30242	30342
Slight vibration suppression control selection 1	-	-	-	30143	30243	30343
Slight vibration suppression control selection 2	-	-	-	30144	30244	30344
Induction voltage compensation	-	-	-	30145	30245	30345
Maker setting	-	-	-	30146	30246	30346
Maker setting	-	-	-	30147	30247	30347
Maker setting	-	-	-	30148	30248	30348
Gain changing selection	-	-	-	30149	30249	30349
Gain changing condition	-	-	-	30150	30250	30350
Gain changing time constant	-	-	-	30151	30251	30351
Ratio of load inertia moment to servo motor inertia moment 2	-	-	-	30152	30252	30352
Position loop gain 2 changing ratio	-	-	-	30153	30253	30353
Speed loop gain 2 changing ratio	-	-	-	30154	30254	30354
Speed integral compensation changing ratio	-	-	-	30155	30255	30355
Maker setting	-	-	-	30156	30256	30356
Maker setting	-	-	-	30157	30257	30357
Maker setting	-	-	-	30158	30258	30358
Maker setting	-	-	-	30159	30259	30359
Optional function C	-	-	-	30160	30260	30360
Machine resonance suppression filter	-	-	-	30161	30261	30361
Maker setting	-	-	-	30162	30262	30362
Maker setting	-	-	-	30163	30263	30363
Maker setting	-	-	-	30164	30264	30364
Maker setting	-	-	-	30165	30265	30365
Maker setting	-	-	-	30166	30266	30366

Item of A1SD75M□	Buffer memory address	
	A1SD75M□	QD75M□
	Common for axis 1,2,3	Common for axis 1,2,3,4
[Md.1] In test mode flag	450	1200
[Md.2] Module name	451	-
[Md.3] OS type	452 453 454 455	-
[Md.4] OS version	456 457	-
[Md.5] Clock data (Hour: minute)	460	-
[Md.6] Clock data (Second: 100ms)	461	-
(Pointer number)	(0) to (15)	
[Md.7] Start axis (QD75M□: [Md.3] Start information)	462 to 537	1212 to 1287
[Md.8] Operation type (QD75M□: [Md.4] Start No.)	463 to 538	1213 to 1288
[Md.9] Start time (Hour: minute) (QD75M□: [Md.5] Start (Hour))	464 to 539	1214 to 1289
[Md.10] Start time (Second: 100ms) (QD75M□: [Md.6] Start (Minute: second))	465 to 540	1215 to 1290
[Md.11] Error judgment	466 to 541	1216 to 1291
[Md.12] Start history pointer	542	1292
(Pointer number)	(0) to (15)	
[Md.13] Start axis	543 to 618	-
[Md.14] Operation type	544 to 619	-
[Md.15] Start time (Hour: minute)	545 to 620	-
[Md.16] Start time (Second: 100ms)	546 to 621	-
[Md.17] Error judgment	547 to 622	-
[Md.18] Start history pointer at error	623	-
(Pointer number)	(0) to (15)	
[Md.19] Axis in which the error occurred	624 to 684	1293 to 1353
[Md.20] Axis error No.	625 to 685	1294 to 1354
[Md.21] Axis error occurrence time (Hour: minute) (QD75M□: [Md.11] Axis error occurrence (Hour))	626 to 686	1295 to 1355
[Md.22] Axis error occurrence time (Second: 100ms) (QD75M□: [Md.12] Axis error occurrence (Minute: second))	627 to 687	1296 to 1356
[Md.23] Error history pointer	688	1357

Item of A1SD75M□	Buffer memory address	
	A1SD75M□	QD75M□
	Common for axis 1,2,3	Common for axis 1,2,3,4
(Pointer number)	(0) to (15)	
[Md.24] Axis in which the warning occurred	689 to 749	1358 to 1418
[Md.25] Axis warning No.	690 to 750	1359 to 1419
[Md.26] Axis warning occurrence time (Hour: minute)	691 to 751	1360 to 1420
(QD75□: [Md.16] Axis warning occurrence (Hour))		
[Md.27] Axis warning occurrence time (Second: 100ms)	692 to 752	1361 to 1421
(QD75M□: [Md.17] Axis warning occurrence (Minute: second))		
[Md.28] Warning history pointer	753	1422

Item of A1SD75M□	Buffer memory address					
	A1SD75M□			QD75M□		
	Axis 1	Axis 2	Axis 3	Axis 1	Axis 2	Axis 3
Md.29 Current feed value	800	900	1000	800	900	1000
	801	901	1001	801	901	1001
Md.30 Machine feed value	802	902	1002	802	902	1002
	803	903	1003	803	903	1003
Md.31 Feedrate	804	904	1004	804	904	1004
	805	905	1005	805	905	1005
Md.32 Valid M code	806	906	1006	808	908	1008
Md.33 Axis error No.	807	907	1007	806	906	1006
Md.34 Axis warning No.	808	908	1008	807	907	1007
Md.35 Axis operation status	809	909	1009	809	909	1009
Md.36 Current speed	810	910	1010	810	910	1010
				811	911	1011
Md.37 Axis feedrate	812	912	1012	812	912	1012
	813	913	1013	813	913	1013
Md.38 Speed-position switching control positioning amount	814	914	1014	814	914	1014
	815	915	1015	815	915	1015
Md.39 External input signal	816	916	1016	816	916	1016
Md.40 Status	817	917	1017	817	917	1017
Md.41 Target value	818	918	1018	818	918	1018
	819	919	1019	819	919	1019
Md.42 Target speed	820	920	1020	820	920	1020
	821	921	1021	821	921	1021
Md.43 OP absolute position	822	922	1022	-	-	-
	823	923	1023			
Md.44 Movement amount after near-point dog ON	824	924	1024	824	924	1024
	825	925	1025	825	925	1025
Md.45 Torque limit stored value	826	926	1026	826	926	1026
Md.46 Special start data instruction code setting value	827	927	1027	827	927	1027
Md.47 Special start data instruction parameter setting value	828	928	1028	828	928	1028
Md.48 Start positioning data No. setting value	829	929	1029	829	929	1029
Md.49 In speed control flag	830	930	1030	830	930	1030
Md.50 In speed change processing flag	831	931	1031	831	931	1031
Md.51 Start data pointer being executed	832	932	1032	834	934	1034
Md.52 Last executed positioning data No.	833	933	1033	837	937	1037
Md.53 Repeat counter						
(QD75M□: Md.41 Special start repetition counter)	834	934	1034	832	932	1032
Md.54 Positioning data No. being executed	835	935	1035	835	935	1035
Md.55 Block No. being executed	836	936	1036	836	936	1036
Md.56 Positioning data being executed	838 to 847	938 to 947	1038 to 1047	838 to 847	938 to 947	1038 to 1047
Md.100 OPR re-travel value	848	948	1048	848	948	1048
	849	949	1049	849	949	1049
Md.101 Real current value	850	950	1050	850	950	1050
	851	951	1051	851	951	1051

Item of A1SD75M□	Buffer memory address					
	A1SD75M□			QD75M□		
	Axis 1	Axis 2	Axis 3	Axis 1	Axis 2	Axis 3
Md.102 Deviation counter value	852	952	1052	852	952	1052
	853	953	1053	853	953	1053
Md.103 Motor rotation	854	954	1054	854	954	1054
	855	955	1055	855	955	1055
Md.104 Motor current	856	956	1056	856	956	1056
Md.105 Auto tuning	857	957	1057	857	957	1057
Md.106 Load inertia ratio	858	958	1058	858	958	1058
Md.107 Position loop gain 1	859	959	1059	859	959	1059
Md.108 Speed loop gain 1	860	960	1060	860	960	1060
Md.109 Position loop gain 2	861	961	1061	861	961	1061
Md.110 Speed loop gain 2	862	962	1062	862	962	1062
Pr.111 Speed integral compensation	863	963	1063	863	963	1063
Md.112 Servo amplifier software No.	864 to 869	964 to 969	1064 to 1069	864 to 869	964 to 969	1064 to 1069
Md.113 Parameter error (No.1 to 15)	870	970	1070	870	970	1070
Md.114 Parameter error (No.16 to 31)	871	971	1071	871	971	1071
Md.115 Parameter error (No.32 to 47)	872	972	1072	872	972	1072
Parameter error (No.48 to 63)	-			873	973	1073
Parameter error (No.64 to 75)	-			874	974	1074
Maker setting	-			875	975	1075
	-			876	976	1076
Md.116 Servo status	873	973	1073	877	977	1077
Md.117 Regenerative load ratio	876	976	1076	878	978	1078
Md.118 Effective load ratio	877	977	1077	879	979	1079
Md.119 Peak load ratio	878	978	1078	880	980	1080
Md.121 Absolute position restoration mode	879	979	1079			
Md.120 FeRAM access count	880 to 883	980 to 983	1080 to 1083			
Deceleration start flag	-			899	999	1099

Item of A1SD75M□	Buffer memory address					
	A1SD75M□			QD75M□		
	Axis 1	Axis 2	Axis 3	Axis 1	Axis 2	Axis 3
Cd.1 Clock data setting (hour)	1100			-		
Cd.2 Clock data setting (minute, second)	1101			-		
Cd.3 Clock data writing	1102			-		
Cd.4 Target axis	1103			-		
Cd.5 Positioning data No.	1104			-		
Cd.6 Write pattern	1105			-		
Cd.7 Read/write request	1106			-		
Cd.8 Read/write positioning data I/F	1108 to 1137			-		
Cd.9 Flash ROM write request	1138			1900		
Cd.10 Parameter initialization request	1139			1901		
Cd.11 Positioning start No.	1150	1200	1250	1500	1600	1700
Cd.12 Axis error reset	1151	1201	1251	1502	1602	1702
Cd.13 Restart command	1152	1202	1252	1503	1603	1703
Cd.14 M code OFF request	1153	1203	1253	1504	1604	1704
Cd.15 New current value	1154	1204	1254	1506	1606	1706
	1155	1205	1255	1507	1607	1707
Cd.16 New speed value	1156	1206	1256	1514	1614	1714
	1157	1207	1257	1515	1615	1715
Cd.17 Speed change request	1158	1208	1258	1516	1616	1716
Cd.18 Positioning operation speed override	1159	1209	1259	1513	1613	1713
Cd.19 JOG speed	1160	1210	1260	1518	1618	1718
	1161	1211	1261	1519	1619	1719
Cd.20 Speed-position switching enable flag	1163	1213	1263	1528	1628	1728
Cd.21 Speed-position switching control movement amount change register	1164	1214	1264	1526	1626	1726
	1165	1215	1265	1527	1627	1727
Cd.22 Manual pulse generator enable flag	1167	1217	1267	1524	1624	1724
Cd.23 Manual pulse generator 1 pulse input magnification	1168	1218	1268	1522	1622	1722
	1169	1219	1269	1523	1623	1723
Cd.24 OPR return request flag OFF request	1170	1220	1270	1521	1621	1721
Cd.25 External start valid (QD75M□: Cd.8 External command valid)	1171	1221	1271	1505	1605	1705
Cd.26 Step valid flag	1172	1222	1272	1545	1645	1745
Cd.27 Step mode	1173	1223	1273	1544	1644	1744
Cd.28 Step start information	1174	1224	1274	1546	1646	1746
Cd.29 Skip command	1175	1225	1275	1547	1647	1747
Cd.30 New torque value	1176	1226	1276	1525	1625	1725
Cd.31 Positioning starting point No.	1178	1228	1278	1501	1601	1701
Cd.100 Servo OFF command	1179	1229	1279	1551	1651	1751
Cd.101 Torque output setting value	1180	1230	1280	1552	1652	1752

Item of A1SD75M□	Buffer memory address					
	A1SD75M□			QD75M□		
	Axis 1	Axis 2	Axis 3	Axis 1	Axis 2	Axis 3
[Cd.32] Interrupt request during continuous operation	1181	1231	1281	1520	1620	1720
[Cd.33] New acceleration time value	1184	1234	1284	1508	1608	1708
	1185	1235	1285	1509	1609	1709
[Cd.34] New deceleration time value	1186	1236	1286	1510	1610	1710
	1187	1237	1287	1511	1611	1711
[Cd.35] Acceleration/deceleration time change during speed change, enable/disable selection	1188	1238	1288	1512	1612	1712
Deceleration start flag valid	-			1905		
Stop command processing for deceleration stop selection	-			1907		
Servo OFF command	-			1551	1651	1751
Torque output setting value	-			1552	1652	1752
Servo amplifier data read	-			1553	1653	1753

Item of A1SD75M□		Buffer memory address																								
		A1SD75M□						QD75M□																		
		Axis 1		Axis 2		Axis 3		Axis 1		Axis 2		Axis 3														
Positioning data*1	Da.1 Operation pattern	No.1	1300		2300		3300		2000		8000		14000													
	Da.2 Control system																									
	Da.3 Acceleration time No.																									
	Da.4 Deceleration time No.																									
	Da.9 M code/condition data		1301		2301		3301		2001		8001		14001													
	Da.8 Dwell time/JUMP destination positioning data No.		1302		2302		3302		2002		8002		14002													
	Not used		1303		2303		3303		2003		8003		14003													
	Da.7 Command speed		1304		2304		3304		2004		8004		14004													
	Da.5 Positioning address/movement amount		1305		2305		3305		2005		8005		14005													
			1306		2306		3306		2006		8006		14006													
	Da.6 Arc address		1307		2307		3307		2007		8007		14007													
			1308		2308		3308		2008		8008		14008													
	No.2		1309		2309		3309		2009		8009		14009													
	No.2		1310 to 1319		2310 to 2319		3310 to 3319		2010 to 2019		8010 to 8019		14010 to 14019													
No.3	1320 to 1329		2320 to 2329		3320 to 3329		2020 to 2029		8020 to 8029		14020 to 14029															
to	to		to		to		to		to		to															
No.100	2290 to 2299		3290 to 3299		4290 to 4299		2990 to 2999		8990 to 8999		14990 to 14999															
Start block data*2	Da.10 Shape	1st point	4300		4350		4550		4600		4800		4850		26000		26050		27000		27050		28000		28050	
	Da.11 Start data No.		4301		4351		4551		4601		4801		4851		26001		26051		27001		27051		28001		28051	
	Da.12 Special start instruction		4302		4352		4552		4602		4802		4852		26002		26052		27002		27052		28002		28052	
	Da.13 Parameter		to		to		to		to		to		to		to		to		to		to		to		to	
	2nd point		4349		4399		4599		4649		4849		4899		26049		26099		27049		27099		28049		28099	
	50th point		4349		4399		4599		4649		4849		4899		26049		26099		27049		27099		28049		28099	
Condition data	Da.14 Condition target	No.1	4400		4650		4900		26100		27100		28100													
	Da.15 Condition operator		4402		4652		4902		26102		27102		28102													
			4403		4653		4903		26103		27103		28103													
	Da.16 Address		4404		4654		4904		26104		27104		28104													
			4405		4655		4905		26105		27105		28105													
	Da.17 Parameter 1		4406		4656		4906		26106		27106		28106													
			4407		4657		4907		26107		27107		28107													
	Da.18 Parameter 2		4410 to 4419		4660 to 4669		4910 to 4919		26110 to 26119		27110 to 27119		28110 to 28119													
	No.2		4420 to 4429		4670 to 4679		4920 to 4929		26120 to 26129		27120 to 27129		28120 to 28129													
	No.3		to		to		to		to		to		to													
	to		4490 to 4499		4740 to 4749		4990 to 4999		26190 to 26199		27190 to 27199		28190 to 28199													
No.10	4490 to 4499		4740 to 4749		4990 to 4999		26190 to 26199		27190 to 27199		28190 to 28199															

*1 With the QD75M□, the positioning data buffer memory addresses are No. 1 to 600.

*2 With the QD75M□, it is called "block start data".

*3 With the QD75M□, the "block start data" and "condition data" in are called "start block 0". There are five start blocks: 0 to 4.

Item of A1SD75M□			Buffer memory address					
			A1SD75M□			QD75M□		
			Axis 1	Axis 2	Axis 3	Axis 1	Axis 2	Axis 3
Positioning start information	Indirect designation	Start No.8001	4500	4750	5000	-	-	-
		Start No.8002	4501	4751	5001	-	-	-
		to	to	to	to	to	to	to
		Start No.8050	4549	4799	5049	-	-	-
Programmable controller CPU memory area	Condition judgment target data of the condition data		5050			30000		
			to			to		
			5099			30049		
Target axis			5100			-		
Head positioning block No.			5101			-		
No. of read/write data items			5102			-		
Read/write request			5103			-		
Read/write block			5110 to 6109			-		

8.3.5 External interface specifications comparison

The following table lists the differences of the external interface specifications between the A1SD75M□ and QD75M□.

(1) Electrical specifications comparison

○ : Compatible, △ : Partial change required

Item		Difference*	compati- bility	Precautions for replacement
Input	Upper/lower limit signal	OFF current:1.5mA→1.0mA Input resistance: 4.7kΩ→6.8kΩ	△	Check whether the OFF current value met satisfied values
	Stop signal	OFF current:1.5mA→1.0mA Input resistance: 4.7kΩ→6.8kΩ	△	Check whether the OFF current value met satisfied values
	Near-point dog signal	OFF current:1.5mA→1.0mA Input resistance: 4.7kΩ→6.8kΩ Response time: 4ms→1ms	△	Check whether the OFF current value met satisfied values
	External command signal (CHG)	OFF current:1.5mA→1.0mA Input resistance: 4.7kΩ→6.8kΩ Response time: 4ms→1ms	△	Check whether the OFF current value met satisfied values
	Manual pulse generator	ON current: 3.5mA→1.0mA Input resistance:1.5k→1.2kΩ	○	

* The column of interface specifications differences is described as the form, [Specifications of A1SD75M□] → [Specifications of QD75M□].

(2) Signal layout comparison

When using with QD75M□, change the connector and wiring.

Name	A1SD75M□		QD75M□	
	Logic (Initial setting)	Logic switching by parameter	Logic (Initial setting)	Logic switching by parameter
Manual pulse generator A phase	Negative logic (multiple of 4)	Not allowed	Negative logic (multiple of 4)	Allowed
Manual pulse generator B phase ^{*1}				
Near-Point signal	Negative logic	Not allowed	Negative logic	Allowed
Stop signal	Negative logic	Not allowed	Negative logic	Allowed
Upper limit	Negative logic	Not allowed	Negative logic	Allowed
Lower limit	Negative logic	Not allowed	Negative logic	Allowed
External start ^{*2}	Negative logic	Not allowed	Negative logic	Allowed
Speed-position switching signal ^{*2}	Negative logic	Not allowed		

*1 The following shows comparisons about manual pulse generator A phase/B phase.

	A1SD75M□	QD75M□
Number of connections	1 generator/axis	1 generator/module
Mode change (Parameter)	Not allowed	Allowed 1 x mode, 2 x mode, 4 x mode, PLS/SIGN mode

*2 With the QD75M□, the "external start signal" and "speed-position switching signal" are combined into the "external command signal/switching signal".

(3) Supported servo amplifier

(a) For continuous use of a servo amplifier connected with the existing A1SD75M/AD75M

The following table shows whether or not the existing servo amplifier can be continuously used with positioning modules replaced.

A1SD75M□/AD75M□ Supported amplifier model	QD75M□ Availability	Remarks
MR-J□-B	Available	
MR-H□-B	Available	• Needs to change the SSCNET cables (refer to (b) in the next page.)
MR-J2□-B	Available	• Discontinued model
MR-J2S□-B	Available	

☒ Point

(1) Selecting suitable products to replace the existing servo amplifier

When replacing the existing servo amplifier, select a positioning module in the following combinations.

Additionally, the servo motor needs to be replaced.

- Positioning module: QD77MS□ + servo amplifier: MR-J3□-B
- Positioning module: QD77MS□ + servo amplifier: MR-J4□-B

(2) Selecting suitable products to replace the existing servo amplifier without servo motor replacement

When replacing the existing servo amplifier alone without servo motor replacement, select a module in the following combination.

- Positioning module: QD75M
 - + Servo amplifier: MR-J4-B-RJ020
(Conversion Unit for SSCNET of MR-J2S-B Compatible Servo Amplifier)
 - + Converter module: MR-J4-T20
(Conversion Unit for SSCNET of MR-J2S-B)

For replacing servo amplifiers and servo motors, data such as positioning parameters and positioning data need to be changed.

When replacing them, contact the department in charge of Mitsubishi electric servo products.

For replacing the MR-J2So-B, refer to "Transition from MELSERVO-J2-Super/J2M Series to J4 Series Handbook" (L(NA)03093).

(b) For SSCNET cables applicable to the servo amplifiers

The following tables show applicable SSCNET cables when the existing servo amplifier is continuously used.

Replacing positioning modules from the A1SD75M or AD75M to the QD75M requires the change of SSCNET cables.

Table 1. With the servo amplifier MR-J, J2, or J2S

SSCNET cable		Between QD75 and MR-J/ J2/J2S amplifier	Between AD75 and MR-J/ J2/J2S amplifier	Between MR-J/J2/J2S amplifier and MR-J/J2/J2S amplifier
MR-J2HBUS□M		○	×	○
MR-J2HBUS□M-A		×	○	×
MR-HBUS□M		×	×	×
MR-J2CN1	*1	○	×	○
MR-J2CN1-A		×	○	×
MR-HBCNS		×	×	×

*1 Connector set for making the cable by user

Table 2. With the servo amplifier MR-H

SSCNET cable		Between QD75M and MR-H amplifier	Between AD75M and MR-H amplifier	Between MR-H amplifier and MR-H amplifier
MR-J2HBUS□M		×	×	×
MR-J2HBUS□M-A		○	×	×
MR-HBUS□M		×	○	○
MR-J2CN1	*1	×	×	×
MR-J2CN1-A		○	×	×
MR-HBCNS		×	○	○

*1 Connector set for making the cable by user

8.4 A1SD70

8.4.1 Performance specifications comparison

○: Compatible, △: Partial change required, ×: Incompatible

Model		A1SD70	QD73A1	Compat- ibility	Precautions for replacement
Item					
Number of control axes		1 axis	1 axis	○	
Positioning data	Capacity	1 data	1 data	○	
	Setting method	Sequence program	Sequence program	○	
Positioning	Mode	Position control mode (Positioning, two-phase trapezoidal positioning) Speed-position control switch mode	Position control mode (Positioning, two-phase trapezoidal positioning) Speed-position control switch mode	○	
	System	Position control mode: Absolute system/incremental system Speed-position control switch mode: Incremental system	Position control mode: Absolute system/incremental system Speed-position control switch mode: Incremental system	○	
	Position command	-2147483648 to 2147483647 (pulse) (32-bit signed binary)	-2147483648 to 2147483647 (pulse) (32-bit signed binary)	○	
	Speed command	1 to 400,000 (pulse/s)	1 to 4,000,000 (pulse/s)	○	The specification has improved. (Upward-compatibility)
	Acceleration/ deceleration	Automatic trapezoidal acceleration/ deceleration	Automatic trapezoidal acceleration/ deceleration	○	
	Automatic acceleration/ deceleration	Acceleration time: 2 to 9999 (ms) Deceleration time: 2 to 9999 (ms)	Acceleration time: 2 to 9999 (ms) Deceleration time: 2 to 9999 (ms)	○	
	In-position range	1 to 2047 pulse	1 to 20479 pulse	○	The specification has improved. (Upward-compatibility)
	Backlash compensation	×	×	○	
	Error correction function	×	×	○	
Speed command output		0 to ±10VDC (Adjustable to set in the range of ±5 to ±10VDC)	0 to ±10VDC (Adjustable to set in the range of ±5 to ±10VDC)	○	
Positioning feedback pulse input	Pulse frequency	Open collector : 100kpulse/s TTL: 100kpulse/s Differential output: 100kpulse/s	Open collector: 200kpulse/s TTL: 200kpulse/s Differential output: 1Mpulse/s	○	The specification has improved. (Upward-compatibility)
	Connectable encoder type	Open collector, TTL, or differential output	Open collector, TTL, or differential output	○	
	Multiplica-tion setting	The number of input feedback pulses can be multiplied by 4, 2, 1, or 1/2.	The number of input feedback pulses can be multiplied by 4, 2, 1, or 1/2.	○	
OPR control		Available (2 method)	Available (2 method)	○	The setting method is changed from a hardware switch to PLC parameter of a CPU module. The function is the same though the setting method is changed.
JOG operation		○	○	○	
Starting time		Absolute system: 4.4ms ^{*1} Incremental system: 4.5ms ^{*1} JOG operation: 4.3ms OPR (near-point dog method): 4.4ms OPR (count method): 5.1ms	Absolute system: 1.2ms ^{*1} Incremental system: 1.2ms ^{*1} JOG operation: 1.2ms OPR (near-point dog method): 1.2ms OPR (count method): 1.2ms	○	The specification has improved. (Upward-compatibility)
M function		×	×	○	
Internal current consumption (5VDC)		5VDC 0.3A	5VDC 0.52A	×	The recalculation of internal current consumption (5VDC) is required.

○: Compatible, △: Partial change required, ×: Incompatible

Item	Model A1SD70	QD73A1	Compat- ibility	Precautions for replacement
External supply voltage/ current terminal block	+15VDC, 0.2A -15VDC, 0.02A	-	○	An external power supply is not required.
Number of occupied I/O points	48 points (Number of I/O slots: 2 slots occupied) (I/O assignment: First half 16 points, empty slot, Second half 32 points, special function module)	48 points (Number of I/O slots: 2 slots occupied) (I/O assignment: First half 16 points, empty slot, Second half 32 points, intelligent function module)	○	
Weight	0.4kg	0.2kg	△	

*1 For the A1SD70, 0.2ms is added to the starting time in two-phase trapezoidal positioning mode. For the QD73A1, an extra time is not added even in two-phase trapezoidal positioning mode.

8.4.2 Function comparison

(1) Function comparison between the A1SD70 and the QD73A1

○: Compatible, -: Not available

Function		Description	A1SD70	QD73A1	Precautions for replacement
Major positioning control	Positioning control	Positioning is executed from the current position to a specified position at a specified speed.	○	○	Refer to Section 8.4.6.
	Position control mode	Positioning is executed to the address specified in "Da.2 Positioning address P1" at "Da.3 Positioning speed V1", then to the address specified in "Da.4 Positioning address P2" at "Da.5 Positioning speed V2" by one positioning start signal.	○	○	
	Speed-position control switch mode	Operation starts according to the positioning speed set beforehand by one start signal, then the operation switches to position control by Speed-position switching command signal. If the operation stopped by Stop signal after the input of Speed-position switching command signal, the positioning can be continued by Speed-position mode restart signal. In addition, the positioning address (movement amount) can be changed if it is before the input of Speed-position switching command signal.	○	○	Refer to Section 8.4.6.
JOG operation		Positioning is executed in the specified direction at specified speed while a JOG operation command is on. Turning on the signal starts operation at a specified speed and speed control operation is continued until Stop signal is input.	○	○	
OPR control		A workpiece is returned to an original point following an OPR start command from a CPU module, and the current value is corrected to an OP address after the completion of OPR.	○	○	
Multiplication setting		This function multiplies the feedback pulse frequency from the pulse generator by 4, 2, 1, or 1/2.	○	○	
Electronic gear function		This function controls moving distance and speed by multiplying command pulse output.	○	○	
Deviation counter clear function		This function clears the accumulated pulses in the deviation counter. When the servomotor power is turned off due to an emergency stop during positioning, clearing the accumulated pulses in the deviation counter prevents servomotor rotation at power recovery.	○	○	
Speed change function		This function forces to change speed from a program during positioning control or JOG operation.	○	○	Refer to Section 8.4.6.
Current value change function		This function changes the current feed value to a specified value from a sequence program on the condition other than while BUSY.	○	○	Refer to Section 8.4.6.
In-position function		This function turns on In-position signal while the accumulated pulse amount in the deviation counter is within the specified in-position range. In-position signal can be used as the signal right before positioning completion.	○	○	
Zero/gain adjustment		This function adjusts analog voltage contained in accumulated pulses.	○	○	Refer to Section 8.4.6.

Remarks

Positioning execution time (BUSY signal (X14) ON to Positioning complete signal (X15) ON) of the QD73A1 and A1SD70 may differ because their internal processing methods are different. As a result, the timing when In-position signal (X16) turns on may also vary.

Adjust positioning execution time using the following methods if the difference of the positioning execution time (or the timing when In-position signal (X16) turns on) affects the system.

- Adjusting the QD73A1's positioning parameter, "[Pr.6] Acceleration time" or "[Pr.7] Deceleration time".
- Increasing gain by changing the accumulated pulse amount setting through the QD73A1's zero/gain adjustment

(2) Changed function from the A1SD70

Though the functions of the A1SD70 and the QD73A1 are same, the setting methods and buffer memory addresses for the functions are partly changed.

To use following functions, changes or corrections of the programs or setting methods are required. For details, refer to the user's manual for the QD73A1.

Changed function	Change description
Major positioning control	Program corrections of the QD73A1 are required because buffer memory addresses for the positioning address, positioning speed, and positioning pattern differ from those of the A1SD70.
OPR function	<ul style="list-style-type: none"> • A1SD70 Amount of movement from the near-point dog ON (buffer memory address: 108, 109), the absolute value of the moving amount is stored. • QD73A1 Near point the amount of movement of the dog after the ON (buffer memory address: 108, 109), the value obtained by adding the homing direction rating Will be paid. Near point movement amount after dog ON (absolute value) (Buffer Memory Address: 118, 119) in, the amount of movement Absolute value is stored.
Speed-position control switch mode (speed control operation)	<ul style="list-style-type: none"> • A1SD70 For Velocity/position axis travel distance change area, the value is reflected during speed control. Setting value: 0 to 2147483647 (valid within the stroke range) • QD73A1 For New speed-position movement amount, the value is cleared to 0 when the next operation starts and reflected when Speed-position switching command signal is turned on. Setting value: 1 to 2147483647 (valid within the stroke range)
Speed change function	<ul style="list-style-type: none"> • A1SD70 The speed change is requested by writing a new speed value in Velocity change area of the buffer memory. • QD73A1 The speed change is requested by writing a new speed value in the buffer memory and writing "1" to Speed change request (buffer memory address: 91). <p>* To use the speed change function, an additional program is required.*1</p>
Current value change function	<ul style="list-style-type: none"> • A1SD70 The current value is changed by writing a new address in Present value change area of the buffer memory. • QD73A1 The current value is changed by writing a new address in New current value of the buffer memory and writing "1" to Current value change request (buffer memory address: 90).
Zero/gain adjustment	<ul style="list-style-type: none"> • A1SD70 The adjustment is performed using the volumes for zero/gain adjustment. • QD73A1 The adjustment is performed by either of following methods. 1) Using the UP/DOWN switch for zero/gain adjustment The function is the same as the A1SD70 though the QD73A1 uses the UP/DOWN switch instead of the volumes. 2) Using the buffer memory To use the buffer memory for the adjustment, create a program.*1
Mode switch	<ul style="list-style-type: none"> • A1SD70 The setting is configured with slide switches or encoder interface setting pin (hardware setting) 1) Slide switches Rotation direction, accumulated pulse, multiplication setting, zero-return direction, zero-return mode, and zero/gain adjustment mode setting/clear 2) Encoder interface setting pin Encoder output types • QD73A1 The setting is configured with the intelligent function module switch setting of GX Works2 or the switch setting of parameter I/O assignment of GX Developer. <p>* Though the setting method is changed from a hardware switch to parameters of software, the same level of settings are available because the function is upward compatible.</p>
LED	Refer to *2.

*1 Example of an additional program (using a buffer memory address for the speed change function)

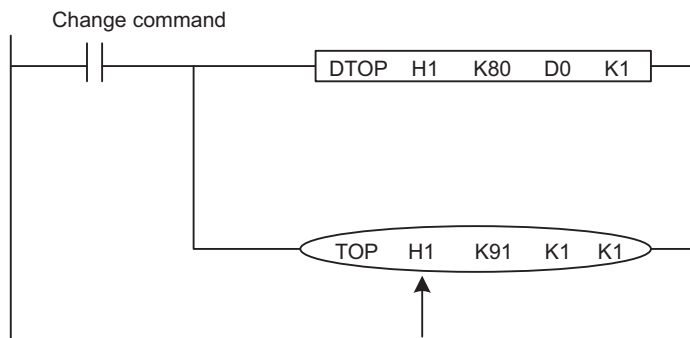

* Create the above due to the speed demand.

*2 Details of LEDs are shown in the table below.

LED name	A1SD70	QD73A1	Remarks ^{*3}
RUN	-	RUN	
Minor error	ERR.1	ERR.	Used for both minor errors and major errors.
Major error	ERR.2		
Encoder phase A	φA	φA	
Encoder phase B	φB	φB	
Encoder phase Z	φZ	φZ	
BUSY	BUSY	BUSY	
Zero adjustment status	-	ZERO	The contents indicated with "ZERO" of the QD73A1 differ from the ones indicated with "ZERO" of the A1SD70.
Gain adjustment status	-	GAIN	
Servo READY	SV RDY	-	Can be checked with an input signal "X1B".
Near-zero point dog	DOG	-	Can be checked with an input signal "X1C".
Stop	STOP	-	Can be checked with an input signal "X1D".
Upper limit LS	FLS	-	Can be checked with an input signal "X1E".
Lower limit LS	RLS	-	Can be checked with an input signal "X1F".
In-Position	IN-POS	-	Can be checked with an input signal "X16".
Error counter polarity	POLE	-	Can be checked with buffer memory addresses "106, 107".
Error counter value	2 ⁿ	-	The LED "POLE" of the A1SD70 indicates ON when the deviation counter value is "-", and indicates OFF when the deviation counter value is "+".
PC READY	PC RDY	-	Check the on/off status of an output signal "Y2D" with a device monitor.
Zero-return request	ZERO	-	Can be checked with an input signal "X12". The contents indicated with "ZERO" of the A1SD70 differ from the ones indicated with "ZERO" of the QD73A1.
Excessive error	EEX	-	Can be checked with an input signal "X17".
WDT error	WDT ERR	-	Can be checked with an input signal "X10".
During velocity operation	V-MODE	-	Can be checked with an input signal "X2D".

*3 The I/O signals shown in the table are the ones when the QD73A1 is mounted on the slots "0, 1" of a main base unit.

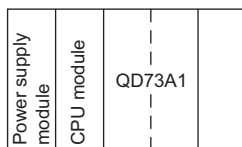

8.4.3 I/O signals comparison

Some I/O signals are added a function.

When an additional function is used, an addition or change of a sequence program is required.

For details of the I/O signals or sequence program, refer to the MELSEC-Q QD73A1 Positioning Module User's Manual.

Input (X)			Output (Y)		
Signal name	A1SD70	QD73A1	Signal name	A1SD70	QD73A1
Unused (The first half slot is Empty 16 points.)* ¹	X00 to X0F	X00 to X0F	Unused (The first half slot is Empty 16 points.)* ¹	Y00 to Y0F	Y00 to Y0F
WDT error, H/W error	X10	X10	Zero/gain adjustment data writing request	-	Y1A
Module READY	X11	X11	Zero/gain adjustment change request	-	Y1B
OPR request	X12	X12	Set value change request	-	Y1C
OPR complete	X13	X13	OPR start	Y20	Y20
BUSY	X14	X14	Absolute positioning start	Y21	Y21
Positioning complete	X15	X15	Forward start	Y22	Y22
In-position	X16	X16	Reverse start	Y23	Y23
Excessive error	X17	X17	Forward JOG start	Y24	Y24
Error detection	X18	X18	Reverse JOG start	Y25	Y25
Overflow	X19	X19	Speed-position mode restart	Y26	Y26
Underflow	X1A	X1A	Stop	Y27	Y27
Servo READY	X1B	X1B	Error reset	Y28	Y28
Near-point dog	X1C	X1C	Overflow reset	Y29	Y29
External stop	X1D	X1D	Underflow reset	Y2A	Y2A
Upper limit signal	X1E	X1E	Speed-position switching enable	Y2C	Y2C
Lower limit signal	X1F	X1F	PLC READY	Y2D	Y2D
OPR start complete	-	X20	Use prohibited* ¹	Y10 to Y1F	Y10 to Y19
Absolute positioning start complete	-	X21		Y2B	Y1D to Y1F
Forward start complete (for the incremental positioning and the speed-position control switching)	-	X22		Y2E, Y2F	
Reverse start complete (for the incremental positioning and the speed-position control switching)	-	X23		-	Y2E, Y2F
Synchronization flag	-	X24			
Zero/gain adjustment data writing complete flag	-	X2A			
Zero/gain adjustment change complete flag	-	X2B			
Set value change complete flag	-	X2C			
Operating status of the speed-position control switch mode	-	X2D			
Use prohibited* ¹	X20 to X2F	X25 to X29 X2E, X2F			

*¹ A "Use prohibited" area is reserved for the system use and cannot be used by a user.

If it is turned on/off through a sequence program, the normal operation of the module cannot be guaranteed.

8.4.4 Buffer memory address comparison

Sequence program change is required because the assignment of buffer memory differs between the modules.

For details of the buffer memory or sequence program, refer to the MELSEC-Q QD73A1 Positioning Module User's Manual.

area shows the differences between the A1SD70 and the QD73A1.

Item		Buffer memory address		
		A1SD70	QD73A1	
Fixed parameter	Stroke limit upper limit	0 1	0 1	
	Stroke limit lower limit	2 3	2 3	
	Electronic gear	Numerator of command pulse multiplication	4	4
		Denominator of command pulse multiplication	5	5
Variable parameter	Speed limit value	20 21	20 21	
	Acceleration time	22	22	
	Deceleration time	23	23	
	In-position range	24	24	
	Positioning mode	25	25	
OPR data	OP address	40 41	40 41	
	OPR speed	42 43	42 43	
	Creep speed	44 45	44 45	
	Setting for the movement amount after near-point dog ON	46 47	46 47	
	Positioning data	Positioning pattern	60	301
Positioning address P ₁		61 62	302 303	
Positioning speed V ₁		63 64	304 305	
Positioning address P ₂		65 66	306 307	
Positioning speed V ₂		67 68	308 309	
Control change area		New current value	80 81	80 81
	New speed value	82 83	82 83	
	JOG speed (area)	84 85	84 85	
	Deviation counter clear command	86	86	
	Analog output adjustment area 1	87	87	
	New speed-position movement amount	88 89	88 89	
	Current value change request	-	90	
	Speed change request	-	91	
	Analog output adjustment area 2	-	92 93	

	Item	Buffer memory address	
		A1SD70	QD73A1
Zero/gain adjustment area	Zero/gain adjustment specification	-	94
	Zero/gain adjustment value specification	-	95
	Factory default zero/gain adjustment value restoration request	-	96
Monitor area	Current feed value	100	100
		101	101
	Actual current value	102	102
		103	103
	Error code (ERR.1)	104	104
	Error code (ERR.2)	105	105
	Deviation counter value	106	116 ^{*1}
		107	117 ^{*1}
	Deviation counter value (address)	-	106 ^{*2}
		-	107 ^{*2}
	Movement amount after near-point dog ON	108	108
		109	109
	Speed-position switching command	110	110
	Control mode	111	111
	Zero/gain execution status	-	112
Zero/gain adjustment status	-	113	
Feedrate	-	114	
	-	115	
Error history	(Record 0) Error code	-	120
	(Record 0) Error occurrence (Year : Month)	-	121
	(Record 0) Error occurrence (Day : Hour)	-	122
	(Record 0) Error occurrence (Minute : Second)	-	123
	(Record 1 to 15)	-	124 to 183
	Error history pointer	-	184

*1 A value of the same specification as A1SD70 is stored. The buffer memory address name of the QD73A1 changes Deviation counter value (pulse). Deviation counter value (pulse) supports the QD73A1 whose serial number (first five digits) is "15042" or later.

*2 When electronic gear setting is 1/1, the value will be the same as Deviation counter value (pulse).

8.4.5 Interface specifications comparison with external devices

For the external interface specifications, the following shows the differences between the A1SD70 and the QD73A1.

○ : Compatible, △ : Partial change required

Item		A1SD70	QD73A1	Compati- bility	Precautions for replacement	
Input	External power supply	+15VDC, 0.2A	-	○	An external power supply terminal block is not available because an external power supply is not required.	
	External input signal	Servo READY	○	○	○	
		Stop signal	○	○	○	
		Near-point dog signal	○	○	○	
		Upper limit signal	○	○	○	
		Lower limit signal	○	○	○	
		Speed-position switching command	○	○	○	
Positioning feedback pulse input	(Pulse frequency) Open collector: 100kpulse/s or less TTL: 100kpulse/s or less Differential: 100kpulse/s or less	(Pulse frequency) Open collector: 200kpulse/s or less TTL: 200kpulse/s or less Differential: 1Mpulse/s or less	○	The specification has improved. (Upward-compatibility)		
Output	Servo ON	○	○	○		
	Speed command (analog signal)	○	○	○		

8.4.6 Precautions for the replacement of the A1SD70 by the QD73A1

The following shows precautions for the replacement of the A1SD70 by the QD73A1.

Item	A1SD70	QD73A1	Precautions
Number of occupied slots	2 slots		*1
Number of occupied I/O points	48 points (I/O assignment: First half slot: Empty 16 points Second half slot: special function module, 32 points)	48 points (I/O assignment: First half slot: Empty 16 points Second half slot: Intelli., 32 points)	*2
Buffer memory address	<ul style="list-style-type: none"> Addresses are partly changed. New items are added due to the specification change. 		*3
Mode setting	Hardware switch setting	Parameter setting of a CPU module ("I/O assignment" → "Switch setting")	*4
LED	<ul style="list-style-type: none"> Items indicated with the LEDs differ between the A1SD70 and the QD73A1. 		*5
External wiring	<ul style="list-style-type: none"> The existing connectors can be used. 		*6*7
Operation of when Servo READY signal is off	The A1SD70 counts the feedback pulse, and outputs the voltage proportional to the deviation counter.	The QD73A1 clears the deviation counter to 0, and outputs 0V.	*8

- *1 The module occupying 2 slots cannot be mounted on the Q series large type base unit. Because the same base unit of the existing module is used for the QD73A1, when mounting the QD73A1 on the Q series large type base unit, use 2 base units by adding an extension base unit.
- *2 When the first half slot for the existing A1SD70 is set to "empty 0 points", configure the I/O assignment setting of parameters in either of following ways so that addresses of the QD73A1 remain the same as the A1SD70 even after the replacement.
 - 1) Set Empty 0 point to the first half slot.
 - 2) Set the same address of the A1SD70 to the second half slot of the QD73A1 in the start XY setting.
- *3 Changes or corrections of the programs are required. For details, refer to the MELSEC-Q QD73A1 Positioning Module User's Manual.
- *4 The method of mode setting, which is required for the positioning, is changed from a hardware switch to the switch setting in I/O assignment of PLC parameter. Configure the same setting as the A1SD70 by referring to the MELSEC-Q QD73A1 Positioning Module User's Manual.
- *5 Items indicated with the LEDs can be checked with I/O signals of the QD73A1. If necessary, install lamps corresponding to the LED indications externally and indicate the on/off status of the I/O signals using a program.
- *6 The position where a module is mounted is changed because the dimensions of a base unit of the QD73A1 differ. In addition, the connector direction is reverse shown as below.

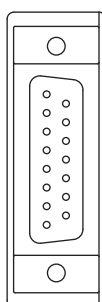

QD73A1

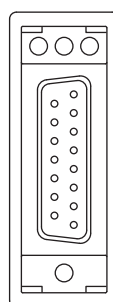

A1SD70

Check whether the wiring is enough even after the replacement because the connector position is changed though the existing connectors can be used without the wiring change.

*7 When the A1SD70 being used in the setting that the positive voltage is output when the positioning address increases (slide switch 1 (rotation direction setting): on) is replaced with the QD73A1, the cables between the A1SD70 and an encoder can be used.

When the A1SD70 being used in the setting that the negative voltage is output when the positioning address increases (slide switch 1 (rotation direction setting): off) is replaced with the QD73A1, the wiring change between the A1SD70 and an encoder is required.

When the A1SD70 is replaced with the QD73A1 whose serial number (first five digits) is "15042" or later, the cables between the A1SD70 and the encoder can be used by changing the intelligent function module switch setting.

<Replacement with the QD73A1 whose serial number (first five digits) is "15041" or earlier>

- Change the wiring between the A1SD70 and the encoder so that each phase A and B is reversed.

No.	Slide switch 1 of the A1SD70 (rotation direction setting)	Rotation direction of the motor and encoder	Wiring between the A1SD70 and encoder	Wiring when the A1SD70 is replaced to the QD73A1
1	OFF	Same direction		
2		Reverse direction		

<Replacement with the QD73A1 whose serial number (first five digits) is "15042" or later>

- Set b0 (switch 3) of the intelligent function module switch to 1.

*8 The operation for the QD73A1 while the signal is off was changed from the operation for the A1SD70 due to the safety consideration of when Servo READY signal is turned on.

The QD73A1 whose serial number (first five digits) is "15042" or later operates the same as the A1SD70 by setting b4 (switch 3) of the intelligent function module switch to 1.

9 POSITION DETECTION MODULE REPLACEMENT

9.1 Position Detection Module Replacement

The A1S62LS position detection module should be considered to be replaced with the absocoder type position sensing module, VS-Q62, manufactured by NSD Corporation (partner company's product).

The absocoder type position sensing module, VS-Q62, can be directly mounted on a Q series base unit.

(1) Finding a replacement module model from the position detection module and absocoder model being used

The existing absocoder can be continuously used by selecting the VS-Q62 for replacement as shown below according to the position detection module and absocoder model being used.

Absocoder model	Q series position detection module for replacement		Existing A series position detection module				
	VS-Q62	VS-Q62B	A61LS	A62LS	A62LS-S5	A63LS	A1S62LS
VRE-P062SAC	-	VS-Q62B-V1PG	○	-	○	-	-
VRE-P028SAC	-		○	-	-	○	○
MRE-32SP062SAC	VS-Q62B-M2PG	VS-Q62B-M2PG	-	○	-	○	○
MRE-G□SP062FAC (□: 64/128/160/256/320)			-	○	○	-	-
VLS-256PWB	VS-Q62-L	VS-Q62B-L	-	○	○	-	-
VLS-512PWB			-	○	○	-	-
VLS-1024PW			-	○	○	-	-
VLS-512PYB			-	-	○	-	-
VLS-1024PYB			-	○	○	-	-
VLS-2048PY			-	○	-	-	-

VS-Q62: Varilimit type (scaling, positioning, switch output)

VS-Q62B: Converter type (position detection function)

(2) Connection cables

The existing cables can be used continuously.
No new wiring is required.

(3) Remote setting module

Select the following remote setting module targeted for the VS-Q62.

	VS-Q62	VS-Q62B	A61LS	A62LS	A62LS-B5	A63LS	A1S62LS
VS-T62	VS-Q62-EDWU		-	-	-	○	○
Module standard equipment	(remote setting module)		-	○	○	-	-

10 REPLACEMENT OF OTHER MODULES

10.1 Replacement of Other Modules

This section lists AnS series modules not introduced in previous chapters and describes their alternative methods. The AnS series modules listed in this section require some special alternative methods because there are no Q series alternative models, or their functions and specifications differ from those of Q series modules.

Product	Model	Alternative method
Pulse catch module	A1SP60	Consider using the interrupt module, QI60, as an alternative. An interrupt program needs to be prepared.
Analog timer module	A1ST60	Consider programmed timer control by indirectly specifying internal timer.
ID interface module	A1SD35ID1	There are no alternative models. Consider using our partner manufacturer's products (ID system "BIS M series" manufactured by Balluff GmbH or ID system "Z series" manufactured by B&PLUS KK), which can be connected to Mitsubishi programmable controllers. (System migration) For details, refer to the technical bulletin (FA-A-0062).
	A1SD35ID2	
Memory card interface module	A1SD59J-S2	Create a file register in a memory card or the standard RAM, and use it as a substitute.

APPENDICES

Appendix 1 External Dimensions

For external dimensions of modules shown in this handbook, refer to the user's manual for each module.

Appendix 2 Spare Parts Storage

- (1) The general specifications of programmable controllers are as follows. Please do not store spare parts under a high temperature or high humidity condition, even within the range guaranteed by the specifications.

Storage ambient temperature	-20 to 75°C
Storage ambient humidity	10 to 90%, no condensation

- (2) Store in a place avoiding direct sunlight.
- (3) Store under condition with less dust or no corrosive gas.
- (4) The battery capacity of a A6BAT battery or a lithium-coin battery (commercially available) for memory card will be decreased by its self-discharging even when not used. Replace it with new one in 5 years as a guideline.
- (5) For a power supply module, CPU module with built-in power supply, or analog module that use any aluminum electrolytic capacitor, which is indicated in the table below, take the following measures since the characteristics will be deteriorated when the aluminum electrolytic capacitor is left un-energized for a long time.

Product	Model (AnS series)
CPU module (Power supply built-in type)	A1SJHCPU
Power supply module	A1S61PN, A1S62PN, A1S63P
Analog module	A1S64AD, A1S68AD, A1S62DA, A1S68DAI, A1S68DAV, A1S63ADA, A1S66ADA

[Countermeasures for preventing aluminum electrolytic capacitor characteristics deterioration]

Apply the rated voltage to the aluminum electrolytic capacitor for several hours once a year to activate it. Or, rotate products at the periodic inspection (in every 1 year or two).

[Reference]

The life of an aluminum electrolytic capacitor, even if not used, under a normal temperature decreases approximately at 1/4 speed of the case when it is energized.

Appendix 3 Relevant Manuals

Appendix 3.1 Replacement handbooks

(1) Transition guide

No.	Manual name	Manual number	Model code
1	MELSEC-A/QnA Series Transition Guide	L08077E	-
2	MELSEC-AnS/QnAS (Small Type) Series Transition Guide	L08236E	-

(2) Transition from MELSEC-A/QnA(large type) to Q series handbook

No.	Manual name	Manual number	Model code
1	Transition from MELSEC-A/QnA (Large Type) Series to Q Series Handbook (Fundamentals)	L08043ENG	-
	Transition from MELSEC-AnS/QnAS (Small Type) Series to Q Series Handbook (Fundamentals)	L08219ENG	-
2	Transition from MELSEC-A/QnA (Large Type) Series to Q Series Handbook (Intelligent Function Modules)	L08046ENG	-
	Transition from MELSEC-AnS/QnAS (Small Type) Series to Q Series Handbook (Intelligent Function Modules)	L08220ENG	-
3	Transition from MELSEC-A/QnA (Large Type), AnS/QnAS (Small Type) Series to Q Series Handbook (Network Modules)	L08048ENG	-
4	Transition from MELSEC-A/QnA (Large Type), AnS/QnAS (Small Type) Series to Q Series Handbook (Communications)	L08050ENG	-
5	Transition from MELSEC-A0J2H Series to Q Series Handbook	L08060ENG	-
6	Transition from MELSECNET/MINI-S3, A2C(I/O) to CC-Link Handbook	L08061ENG	-
7	Transition from MELSEC-I/OLINK to CC-Link/LT Handbook	L08062ENG	-
	Transition from MELSEC-I/OLINK to AnyWire DB A20 Handbook	L08263ENG	-
8	Transition of CPUs in MELSEC Redundant System Handbook (Transition from Q4ARCPU to QnPRHCPU)	L08117ENG	-

(3) Transition Examples

No.	Manual name	Manual number	Model code
1	MELSEC-A/QnA (Large), AnS/QnAS (Small) Transition Examples	L08121E	-

(4) Others

No.	Manual name (technical bulletin)	Manual number	Model code
1	Procedures for Replacing Positioning Module AD71 with QD75	FA-A-0060	-
2	Transition from MELSERVO-J2-Super/J2M Series to J4 Series Handbook	L03093	-
3	Product discontinuation of ID system D-2N series	FA-A-0062	-
4	Production discontinuation of MELSEC-A series models	T12-0016	-

Appendix 3.2 AnS series

No.	Manual name	Manual number	Model code
1	A/D Converter Module Type A1S64AD User's Manual	IB-66336	13J676
2	Analog-Digital Converter Module Type A1S68AD User's Manual	IB-66576	13J757
3	D/A Converter Module Type A1S62DA User's Manual	IB-66335	13J673
4	Digital-Analog Converter Module Type A1S68DAV/DAI User's Manual	IB-66587	13J810
5	Thermocouple Input Module Type A1S68TD User's Manual	IB-66571	13J781
6	Type A68RD3N/4N,A1S62RD3N/4N Pt100 Input Module User's Manual	SH-080193	13JR46
7	A1S62TCTT-S2 Heating-Cooling Temperature Control Module A1S62TCTTBW-S2 Heating-Cooling Temperature Control Module with Wire Breakage Detection Function User's Manual	SH-3643	13JL35
8	A1S62TCRT-S2 Heating-Cooling Temperature Control Module A1S62TCRTBW-S2 Heating-Cooling Temperature Control Module with Wire Breakage Detection Function User's Manual	SH-3644	13JL36
9	Temperature Control Module Type A1S64TCTRT/Temperature Control Module with Disconnection Detection Function Type A1S64TCTRTBW User's Manual	SH-080549ENG	13JR79
10	A1S64TCRT-S1 Temperature Control Module/A1S64TCRTBW-S1 Temperature Control Module with Disconnection Detection Function User's Manual	IB-66756	13JL03
11	A1S64TCTT-S1 Temperature Control Module/A1S64TCTTBW-S1 Temperature Control Module with Disconnection Detection Function User's Manual	IB-66747	13J891
12	Positioning Module Type A1SD70 User's Manual	IB-66367	13JE04
13	A1SD75M1/M2/M3, AD75M1/M2/M3 Positioning Module User's Manual	IB-66715	13J870
14	A1SD75P1-S3/P2-S3/P3-S3, AD75P1-S3/P2-S3/P3-S3 Positioning Module User's Manual	IB-66716	13J871
15	Type A1S62LS User's Manual	IB-66647	13J837
16	High Speed Counter Module Type A1SD61 User's Manual	IB-66337	13J674
17	High Speed Counter Module Type A1SD62, A1SD62E, A1SD62D(S1) User's Manual	IB-66593	13J816
18	Pulse catch module type A1SP60 User's Manual (Hardware)	IB-66477	13JE61
19	Analog timer module type A1ST60 User's Manual (Hardware)	IB-66479	13JE57
21	Analog input/Output Module Type A1S63ADA User's Manual	IB-66435	13JE30
22	Analog Input/Output Module Type A1S66ADA User's Manual	IB-66819	13JL41
23	MELSECNET/MINI-S3 Master Module Type AJ71PT32-S3, AJ71T32-S3, A1SJ71PT32-S3, A1SJ71T32-S3 User's Manual	IB-66565	13JE64
24	AS-i Master module type A1SJ71AS92 User's Manual	SH-080085	13JR15
25	A1SD59J-S2/MIF Memory Card Interface Module User's Manual	SH-080056	13JR05

Appendix 3.3 Q series

No.	Manual name	Manual number	Model code
1	iQ Platform Programmable Controllers MELSEC-Q Series [QnU]	L08101E	–
2	Analog-Digital Converter Module User's Manual Q64AD/Q68ADV/Q68ADI/GX Configurator-AD (SW2D5C-QADU-E)	SH-080055	13JR03
3	Channel Isolated High Resolution Analog-Digital Converter Module / Channel Isolated High Resolution Analog-Digital Converter Module (With Signal Conditioning Function) User's Manual Q64AD-GH/Q62AD-DGH/GX Configurator-AD (SW2D5C-QADU-E)	SH-080277	13JR51
4	Channel Isolated Analog-Digital Converter Module/Channel Isolated Analog-Digital Converter Module (With Signal Conditioning Function) User's Manual Q68AD-G/Q66AD-DG/GX Configurator-AD (SW2D5C-QADU-E)	SH-080647ENG	13JR96
5	Digital-Analog Converter Module User's Manual Q62DAN/Q64DAN/Q68DAVN/Q68DAIN/Q62DA/Q64DA/Q68DAV/ Q68DAI/GX Configurator-DA (SW2D5C-QDAU-E)	SH-080054	13JR02
6	Channel Isolated Digital-Analog Converter Module User's Manual Q62DA-FG/GX Configurator-DA (SW2D5C-QDAU-E)	SH-080281E	13JR52
7	Channel Isolated Digital-Analog Converter Module User's Manual Q66DA-G/GX Configurator-DA (SW2D5C-QDAU-E)	SH-080648ENG	13JR97
8	Analog Input/Output Module User's Manual Q64AD2DA/Configurator-DA (SW2D5C-QADU-E)/GX Configurator-DA (SW2D5C-QDAU-E)	SH-080793ENG	13JZ25
9	RTD Input Module Channel Isolated RTD Input Module User's Manual Q64RD/Q64RD-G/GX Configurator-TI (SW1D5C-QTIU-E)	SH-080142	13JR31
10	Channel Isolated RTD Input Module User's Manual Q68RD3-G/GX Configurator-TI (SW1D5C-QTIU-E)	SH-080722ENG	13JZ06
11	Thermocouple Input Module Channel Isolated Thermocouple/Micro Voltage Input Module User's Manual Q64TD/Q64TDV-GH/GX Configurator-TI (SW1D5C-QTIU-E)	SH-080141	13JR30
12	Channel Isolated Thermocouple Input Module User's Manual Q68TD-G-H01/Q68TD-G-H02/GX Configurator-TI (SW1D5C-QTIU-E)	SH-080795ENG	13JZ26
13	Temperature Control Module User's Manual Q64TCTT/Q64TCTTBW/Q64TCRT/Q64TCRTBW/GX Configurator-TC (SW0D5C-QTCU-E)	SH-080121	13JR21
14	High-Speed Counter Module User's Manual QD62/QD62E/QD62D/GX Configurator-CT (SW0D5C-QCTU-E)	SH-080036	13JL95
15	High Speed Counter Module User's Manual (Hardware) QD62-H01/QD62-H02	IB-0800421	13JY78
16	Type QD75P/QD75D Positioning Module User's Manual QD75P1/QD75P2/QD75P4/QD75D1/QD75D2/QD75D4	SH-080058	13JR09
17	Type QD75M Positioning Module User's Manual QD75M1/QD75M2/QD75M4	IB-0300062	1XB752
18	QD73A1 Positioning Module User's Manual	SH-081075ENG	13JZ69

Appendix 3.4 Programming tool

No.	Manual name	Manual number	Model code
1	GX Works2 Version 1 Operating Manual (Common)	SH-080779ENG	13JU63
2	GX Works2 Version 1 Operating Manual (Intelligent Function Module)	SH-080921ENG	13JU69
3	GX Developer Version 8 Operating Manual	SH-080373E	13JU41

Appendix 4 How to Change Resolution After Analog I/O Module is Replaced

This section describes how to change the resolution of an analog I/O module after the module is replaced from AnS series to Q series.

(1) Resolution of AnS series and Q series analog I/O modules

Each AnS series analog I/O module have different resolutions. Please check the resolution of the module in this handbook or user's manual.

If the resolution differs between AnS series and Q series modules, it needs to be matched by a user (by creating a sequence program or changing user range settings).

○ : Measure required by user, △ : Measure not required by user

Resolution of AnS series analog I/O module	Resolution of Q series analog I/O module				User range (Voltage: 1/12000)
	Normal resolution mode	High resolution mode		Voltage	
		Current	Voltage		
	1/4000	1/12000	1/16000		
1/4000	○	—	—	—	
1/8000	△ ^{*1}	△ ^{*1}	△ ^{*1}	—	
1/12000	—	○	—	△ ^{*2}	

*1 Change the resolution in a sequence program. (Refer to Appendix 4 (2).)

*2 Set a user range in high resolution mode.

(2) Example of sequence program to change a resolution

(Condition)

(a) Resolution of an AnS series analog I/O module: 1/8000

(b) Device that stores a present value read from the analog I/O module: D0

(c) Device that is used for resolution change operation: D100, D101

* Two-/four-word data is used in the four arithmetic operations instruction. Use unused device areas so that existing device data are not affected by this operation.

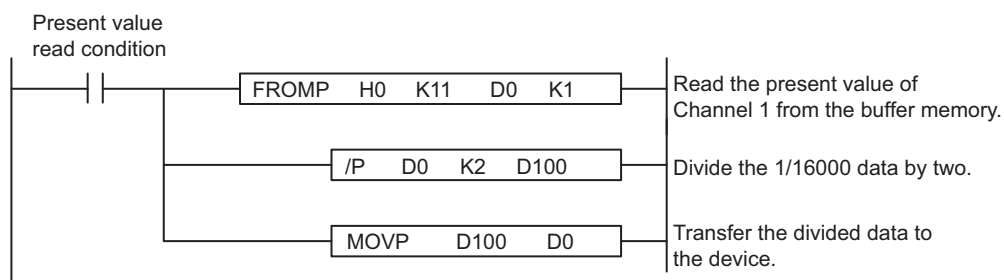

(3) Using the scaling function (for example in the Q68AD-G) to change a resolution

If the module after replacement (for example, the Q68AD-G) supports the scaling function*1, a resolution can be changed using this function.

(Condition)

(a) Resolution of an AnS series analog I/O module: 1/8000 (Only one channel is used.)

(b) Q series analog I/O module: Q68AD-G

(Example of sequence program to set the function and read the scaling value)

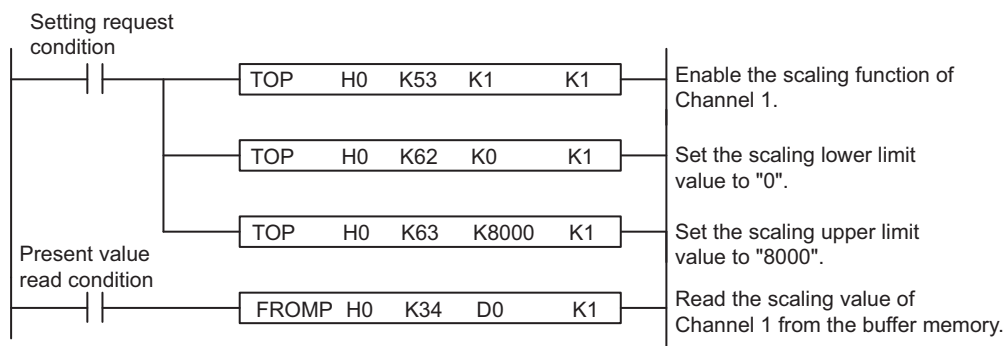

(Buffer memory areas of the Q68AD-G)

Address		Description	Default	Read/Write
Hexadecimal	Decimal			
35 _H	53	Scaling enable/disable setting	00FF _H	R/W
36 _H	54	CH1 Scaling value	0	R
37 _H	55	CH2 Scaling value	0	
38 _H	56	CH3 Scaling value	0	
39 _H	57	CH4 Scaling value	0	
3A _H	58	CH5 Scaling value	0	
3B _H	59	CH6 Scaling value	0	
3C _H	60	CH7 Scaling value	0	
3D _H	61	CH8 Scaling value	0	
3E _H	62	CH1 Scaling lower limit value	0	R/W
3F _H	63	CH1 Scaling upper limit value	0	
40 _H	64	CH2 Scaling lower limit value	0	
41 _H	65	CH2 Scaling upper limit value	0	

*1 For details of the scaling function, refer to the user's manual for the module used.

WARRANTY

Please confirm the following product warranty details before using this product.

1. Gratis Warranty Term and Gratis Warranty Range

If any faults or defects (hereinafter "Failure") found to be the responsibility of Mitsubishi occurs during use of the product within the gratis warranty term, the product shall be repaired at no cost via the sales representative or Mitsubishi Service Company.

However, if repairs are required onsite at domestic or overseas location, expenses to send an engineer will be solely at the customer's discretion. Mitsubishi shall not be held responsible for any re-commissioning, maintenance, or testing on-site that involves replacement of the failed module.

[Gratis Warranty Term]

The gratis warranty term of the product shall be for one year after the date of purchase or delivery to a designated place. Note that after manufacture and shipment from Mitsubishi, the maximum distribution period shall be six (6) months, and the longest gratis warranty term after manufacturing shall be eighteen (18) months. The gratis warranty term of repair parts shall not exceed the gratis warranty term before repairs.

[Gratis Warranty Range]

- (1) The range shall be limited to normal use within the usage state, usage methods and usage environment, etc., which follow the conditions and precautions, etc., given in the instruction manual, user's manual and caution labels on the product.
- (2) Even within the gratis warranty term, repairs shall be charged for in the following cases.
 1. Failure occurring from inappropriate storage or handling, carelessness or negligence by the user. Failure caused by the user's hardware or software design.
 2. Failure caused by unapproved modifications, etc., to the product by the user.
 3. When the Mitsubishi product is assembled into a user's device, Failure that could have been avoided if functions or structures, judged as necessary in the legal safety measures the user's device is subject to or as necessary by industry standards, had been provided.
 4. Failure that could have been avoided if consumable parts (battery, backlight, fuse, etc.) designated in the instruction manual had been correctly serviced or replaced.
 5. Failure caused by external irresistible forces such as fires or abnormal voltages, and Failure caused by force majeure such as earthquakes, lightning, wind and water damage.
 6. Failure caused by reasons unpredictable by scientific technology standards at time of shipment from Mitsubishi.
 7. Any other failure found not to be the responsibility of Mitsubishi or that admitted not to be so by the user.

2. Onerous repair term after discontinuation of production

- (1) Mitsubishi shall accept onerous product repairs for seven (7) years after production of the product is discontinued. Discontinuation of production shall be notified with Mitsubishi Technical Bulletins, etc.
- (2) Product supply (including repair parts) is not available after production is discontinued.

3. Overseas service

Overseas, repairs shall be accepted by Mitsubishi's local overseas FA Center. Note that the repair conditions at each FA Center may differ.

4. Exclusion of loss in opportunity and secondary loss from warranty liability

Regardless of the gratis warranty term, Mitsubishi shall not be liable for compensation to:

- (1) Damages caused by any cause found not to be the responsibility of Mitsubishi.
- (2) Loss in opportunity, lost profits incurred to the user by Failures of Mitsubishi products.
- (3) Special damages and secondary damages whether foreseeable or not, compensation for accidents, and compensation for damages to products other than Mitsubishi products.
- (4) Replacement by the user, maintenance of on-site equipment, start-up test run and other tasks.

5. Changes in product specifications

The specifications given in the catalogs, manuals or technical documents are subject to change without prior notice.

Microsoft and Windows are either registered trademarks or trademarks of Microsoft Corporation in the United States and/or other countries.

Unicode is either a registered trademark or a trademark of Unicode, Inc. in the United States and other countries.

The company names, system names and product names mentioned in this manual are either registered trademarks or trademarks of their respective companies.

In some cases, trademark symbols such as [™] or [®] are not specified in this manual.

Programmable Controller

Country/Region	Sales office	Tel/Fax
USA	MITSUBISHI ELECTRIC AUTOMATION, INC. 500 Corporate Woods Parkway, Vernon Hills, IL 60061, U.S.A.	Tel : +1-847-478-2100 Fax : +1-847-478-2253
Mexico	MITSUBISHI ELECTRIC AUTOMATION, INC. Mexico Branch Mariano Escobedo #69, Col. Zona Industrial, Tlalnepantla Edo. Mexico, C.P.54030	Tel : +52-55-3067-7500
Brazil	MITSUBISHI ELECTRIC DO BRASIL COMÉRCIO E SERVIÇOS LTDA. Avenida Adelino Cardana, 293, 21 andar, Bethaville, Barueri SP, Brazil	Tel : +55-11-4689-3000 Fax : +55-11-4689-3016
Germany	MITSUBISHI ELECTRIC EUROPE B.V. German Branch Mitsubishi-Electric-Platz 1, 40882 Ratingen, Germany	Tel : +49-2102-486-0 Fax : +49-2102-486-1120
UK	MITSUBISHI ELECTRIC EUROPE B.V. UK Branch Travellers Lane, Hatfield, Hertfordshire, AL10 8XB, U.K.	Tel : +44-1707-28-8780 Fax : +44-1707-27-8695
Ireland	MITSUBISHI ELECTRIC EUROPE B.V. Irish Branch Westgate Business Park, Ballymount, Dublin 24, Ireland	Tel : +353-1-4198800 Fax : +353-1-4198890
Italy	MITSUBISHI ELECTRIC EUROPE B.V. Italian Branch Centro Direzionale Colleoni-Palazzo Sirio Viale Colleoni 7, 20864 Agrate Brianza(Milano) Italy	Tel : +39-039-60531 Fax : +39-039-6053-312
Spain	MITSUBISHI ELECTRIC EUROPE, B.V. Spanish Branch Carretera de Rubí, 76-80-Apdo. 420, 08190 Sant Cugat del Vallés (Barcelona), Spain	Tel : +34-935-65-3131 Fax : +34-935-89-1579
France	MITSUBISHI ELECTRIC EUROPE B.V. French Branch 25, Boulevard des Bouvets, 92741 Nanterre Cedex, France	Tel : +33-1-55-68-55-68 Fax : +33-1-55-68-57-57
Czech Republic	MITSUBISHI ELECTRIC EUROPE B.V. Czech Branch Avenir Business Park, Radlicka 751/113e, 158 00 Praha5, Czech Republic	Tel : +420-251-551-470 Fax : +420-251-551-471
Poland	MITSUBISHI ELECTRIC EUROPE B.V. Polish Branch ul. Krakowska 50, 32-083 Balice, Poland	Tel : +48-12-347-65-00 Fax : +48-12-630-47-01
Sweden	MITSUBISHI ELECTRIC EUROPE B.V. (Scandinavia) Fjellievägen 8, SE-22736 Lund, Sweden	Tel : +46-8-625-10-00 Fax : +46-46-39-70-18
Russia	MITSUBISHI ELECTRIC (RUSSIA) LLC St. Petersburg Branch Piskarevsky pr. 2, bld 2, lit "Sch", BC "Benua", office 720; 195027 St. Petersburg, Russia	Tel : +7-812-633-3497 Fax : +7-812-633-3499
Turkey	MITSUBISHI ELECTRIC TURKEY A.Ş Ümraniye Branch Serifali Mahallesi Nutuk Sokak No:5, TR-34775 Umraniye/Istanbul, Turkey	Tel : +90-216-526-3990 Fax : +90-216-526-3995
UAE	MITSUBISHI ELECTRIC EUROPE B.V. Dubai Branch Dubai Silicon Oasis, P.O.BOX 341241, Dubai, U.A.E.	Tel : +971-4-3724716 Fax : +971-4-3724721
South Africa	ADROIT TECHNOLOGIES 20 Waterford Office Park, 189 Witkoppen Road, Fourways, South Africa	Tel : +27-11-658-8100 Fax : +27-11-658-8101
China	MITSUBISHI ELECTRIC AUTOMATION (CHINA) LTD. No.1386 Hongqiao Road, Mitsubishi Electric Automation Center, Shanghai, China	Tel : +86-21-2322-3030 Fax : +86-21-2322-3000
Taiwan	SETSUYO ENTERPRISE CO., LTD. 6F, No.105, Wugong 3rd Road, Wugu District, New Taipei City 24889, Taiwan	Tel : +886-2-2299-2499 Fax : +886-2-2299-2509
Korea	MITSUBISHI ELECTRIC AUTOMATION KOREA CO., LTD. 7F-9F, Gangseo Hangang Xi-tower A, 401, Yangcheon-ro, Gangseo-Gu, Seoul 07528, Korea	Tel : +82-2-3660-9530 Fax : +82-2-3664-8372
Singapore	MITSUBISHI ELECTRIC ASIA PTE. LTD. 307, Alexandra Road, Mitsubishi Electric Building, Singapore 159943	Tel : +65-6473-2308 Fax : +65-6476-7439
Thailand	MITSUBISHI ELECTRIC FACTORY AUTOMATION (THAILAND) CO., LTD. 12th Floor, SV.City Building, Office Tower 1, No. 896/19 and 20 Rama 3 Road, Kwaeng Bangpongpan, Khet Yannawa, Bangkok 10120, Thailand	Tel : +66-2682-6522 Fax : +66-2682-6020
Vietnam	MITSUBISHI ELECTRIC VIETNAM COMPANY LIMITED Hanoi Branch 6th Floor, Detech Tower, 8 Ton That Thuyet Street, My Dinh 2 Ward, Nam Tu Liem District, Hanoi, Vietnam	Tel : +84-4-3937-8075 Fax : +84-4-3937-8076
Indonesia	PT. MITSUBISHI ELECTRIC INDONESIA Gedung Jaya 11th Floor, JL. MH. Thamrin No.12, Jakarta Pusat 10340, Indonesia	Tel : +62-21-3192-6461 Fax : +62-21-3192-3942
India	MITSUBISHI ELECTRIC INDIA PVT. LTD. Pune Branch Emerald House, EL-3, J Block, M.I.D.C., Bhosari, Pune-411026, Maharashtra, India	Tel : +91-20-2710-2000 Fax : +91-20-2710-2100
Australia	MITSUBISHI ELECTRIC AUSTRALIA PTY. LTD. 348 Victoria Road, P.O. Box 11, Rydalmere, N.S.W 2116, Australia	Tel : +61-2-9684-7777 Fax : +61-2-9684-7245

Mitsubishi Electric Corporation Nagoya Works is a factory certified for ISO 14001 (standards for environmental management systems) and ISO 9001 (standards for quality assurance management systems)

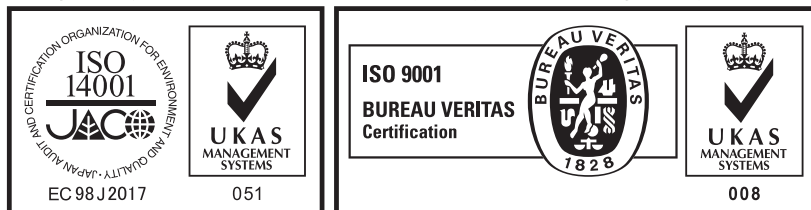

MITSUBISHI ELECTRIC CORPORATION

HEAD OFFICE: TOKYO BUILDING, 2-7-3, MARUNOUCHI, CHIYODA-KU, TOKYO 100-8310, JAPAN
NAGOYA WORKS: 1-14, YADA-MINAMI 5, HIGASHI-KU, NAGOYA, JAPAN